



High-flow self-priming pool pumps at 4 poles up to 10 HP ideal for quiet operation and larger filtration. Cataphoresis painting, screws in AISI316 and pump body in polypropylene with glass fiber give a remarkable resistance to corrosion. In addition, a large support base make the whole system particularly robust.



Bronze impeller on request

### Construction features

<b>Painting</b>	cataphoresis
<b>Pump body, seal housing, diffuser</b>	polypropylene + fiberglass
<b>Motor bracket</b>	aluminum
<b>Impeller</b>	Noryl®, marine bronze on request
<b>Mechanical seal</b>	ceramic-graphite-AISI 316
<b>Motor shaft</b>	stainless steel AISI 316
<b>Liquid temperature</b>	max 40 °C
<b>Pre-filter cover</b>	polycarbonate
<b>Support base</b>	Noryl®

### Motor

<b>4 or 2 poles induction motor</b>	3~ 230V/400V - 50Hz 3~ 400V/690V - 50Hz
<b>Insulation class</b>	F
<b>Protection degree</b>	IP55



# POOL4

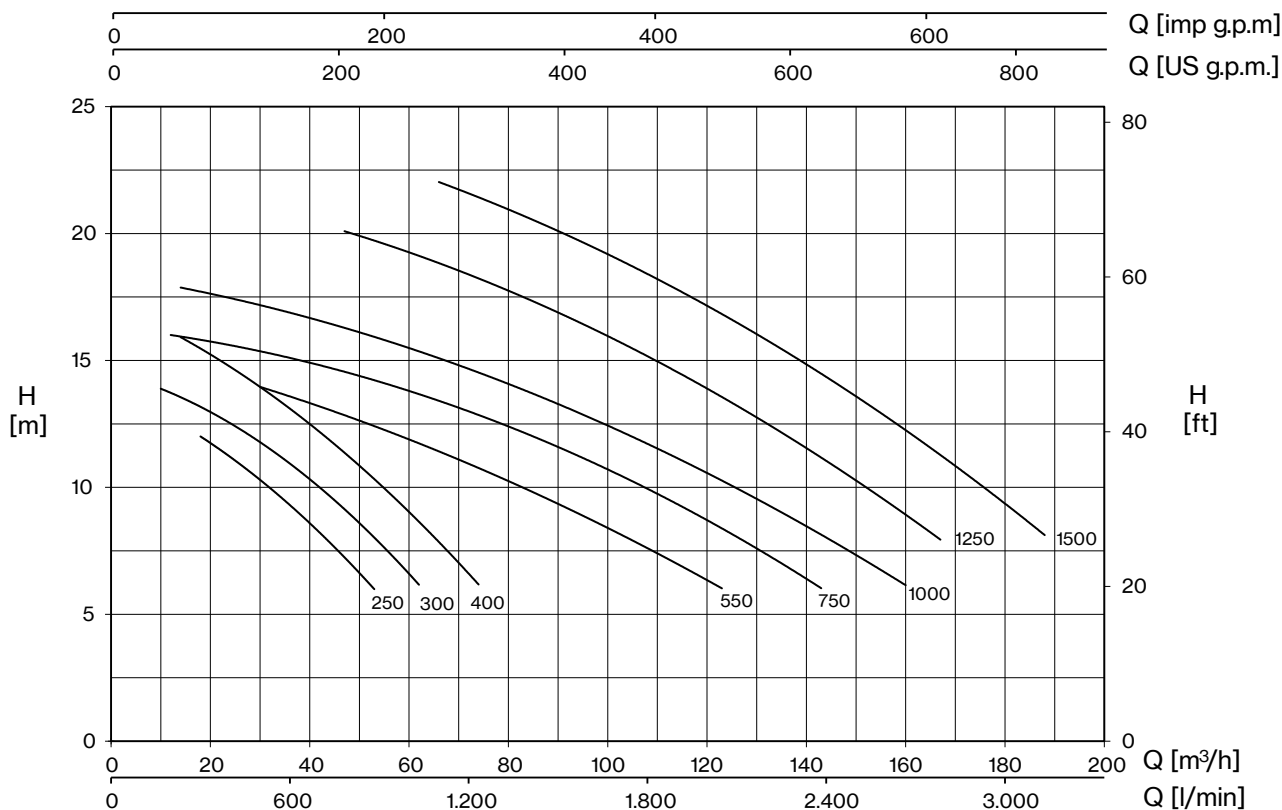

TYPE - 50 Hz	P2		CURRENT		rpm	H (m)											Minimum size of suction pipe			
			3- 230V	3- 400V		6	8	10	12	14	16	18	20	22						
	HP	kW	A			Q (m³/h)														
<b>POOL4 4-250</b>	2,5	1,8	8,5	4,9	1450	53	43	32	18											110
<b>POOL4 4-300</b>	3	2,2	9,4	5,3	1450	62	54	43	26	10										125
<b>POOL4 4-400</b>	4	3	12,5	6,9	1450	74	66	56	42	29	14									140
<b>POOL4 4-550</b>	5,5	4	15,3	8,8	1450	123	104	84	57	30										160
<b>POOL4 4-750</b>	7,5	5,5	-	12	1450	143	127	107	85	57	12									180
<b>POOL4 4-1000</b>	10	7,5	-	15,8	1450	160	145	126	107	80	48	14								180
<b>POOL4 2-1250</b>	12,5	9,2	-	18,5	2850		167	152	136	118	99	80	47							180
<b>POOL4 2-1500</b>	15	11	-	20,9	2850		188	177	162	146	130	112	92	66						200

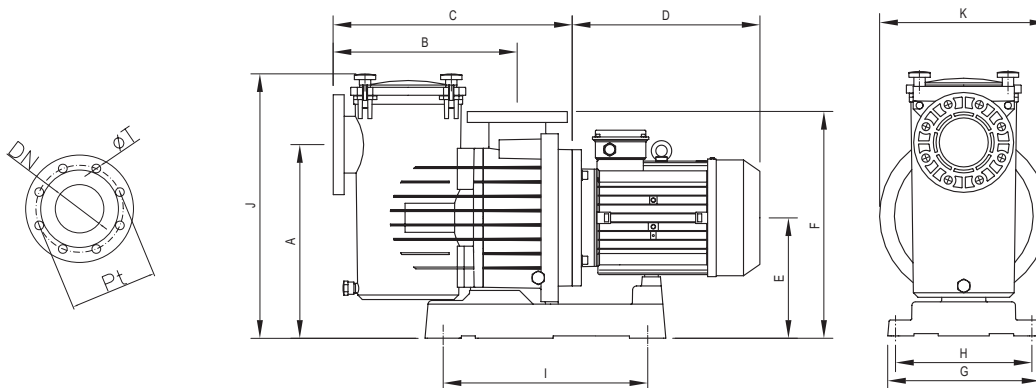

TYPE	DIMENSIONS (mm)															Kg			
	A	B	C	D	E	F	G	H	I	J	K	DNA	DNM	ØT	Pt		A1	H1	L1
<b>POOL4 4-250</b>	420	405	530	310	265	495	335	300	450	590	370	110	16	180		385	595	840	42
<b>POOL4 4-300</b>	420	405	530	310	265	495	335	300	450	590	370					385	595	840	42,5
<b>POOL4 4-400</b>	420	405	530	310	265	495	335	300	450	590	370					385	595	840	44,5
<b>POOL4 4-550</b>	420	405	530	335	265	495	335	300	450	590	370					385	715	1170	53,4
<b>POOL4 4-750</b>	420	405	508	380	265	495	335	300	450	590	370					385	715	1170	66
<b>POOL4 4-1000</b>	420	405	508	380	265	495	335	300	450	590	370					385	715	1170	76
<b>POOL4 2-1250</b>	420	405	508	380	265	495	335	300	450	590	370					385	715	1170	84,5
<b>POOL4 2-1500</b>	420	405	508	380	265	495	335	300	450	590	370					385	715	1170	85,5

