

2U

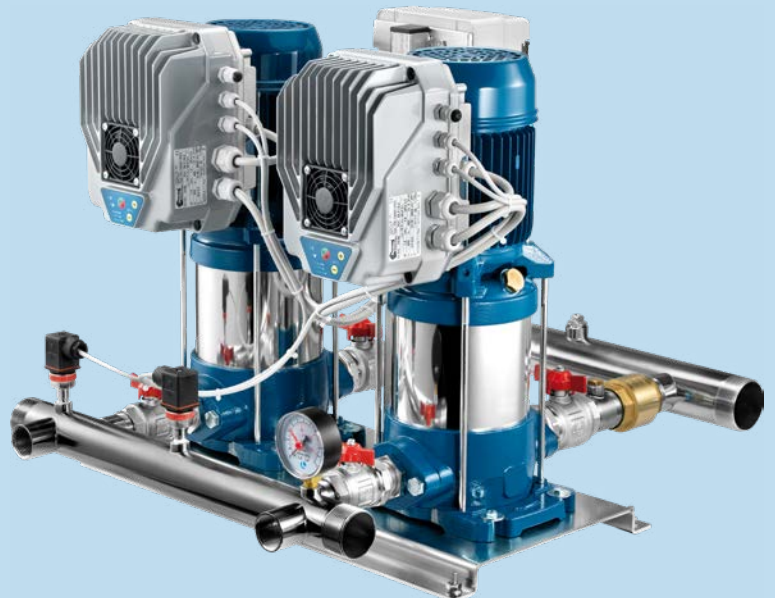

FIXED SPEED PUMPS

VARIABLE SPEED PUMPS



Pump specification

Flow up to 230 m³/h

Head up to 240 m

Start up direct, star/delta, inverter

Power supply voltage 1- 230V - 50Hz
3- 400V - 50Hz

Ambient temperature at nominal load max 40° C

Temperature of pumped liquid -5° C to +35° C (Horizontal pumps with Noryl impellers)
-5° C to +35° C (V-L-LG version)
-15° C to +90° C (SV version)
-15° C to +110° C (S-SL-SLX-SLG-SLXG version)
-15° C to +120° C (HS-HX version)

Name key

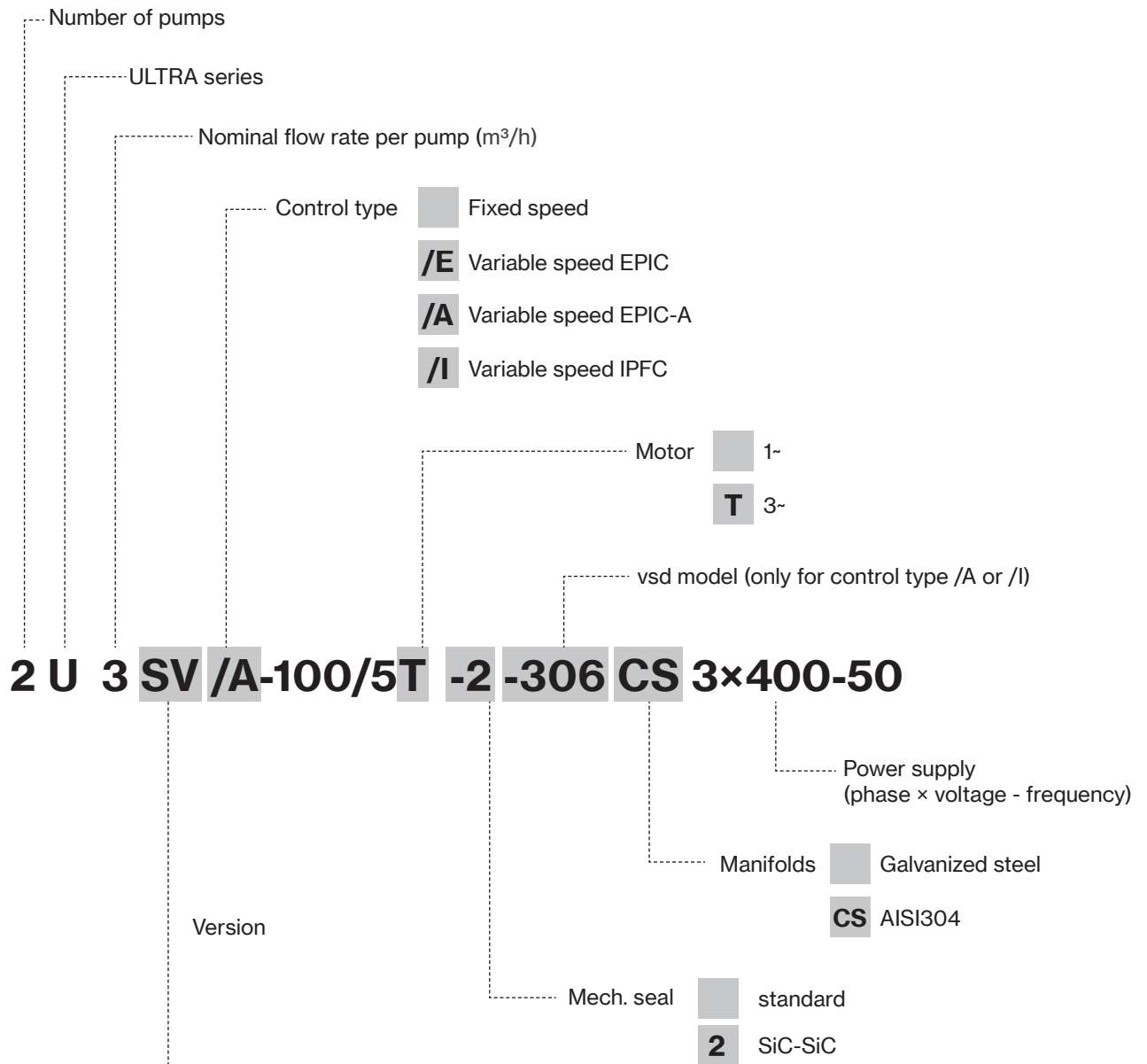

	PUMP TYPE	MAX LIQUID TEMPERATURE	IMPELLERS MATERIAL	PUMP SHELL AND BODY MATERIAL	PUMP AND MOTOR SHAFT	
S	Horizontal multistage	35° C	Noryl®	AISI 304	monoblock	
		110° C	AISI 304	AISI 304		
V	Vertical multistage, overlapped ports	35° C	Noryl®	AISI 304 / cast iron		
		90° C	AISI 304	AISI 304 / cast iron		
L LG SL SLX SLG SLXG HS HX	Vertical multistage, inline ports	35° C	Noryl®	AISI 304 / cast iron		with coupling
		35° C	Noryl®	AISI 304 / cast iron		monoblock
		110° C	AISI 304	AISI 304 / cast iron		with coupling
		110° C	AISI 304	AISI 304		
		110° C	AISI 304	AISI 304 / cast iron		with coupling
		110° C	AISI 304	AISI 304		
		120° C	AISI 304	AISI 304 / cast iron		
		120° C	AISI 316	AISI 316		



Performance data and curves

2U

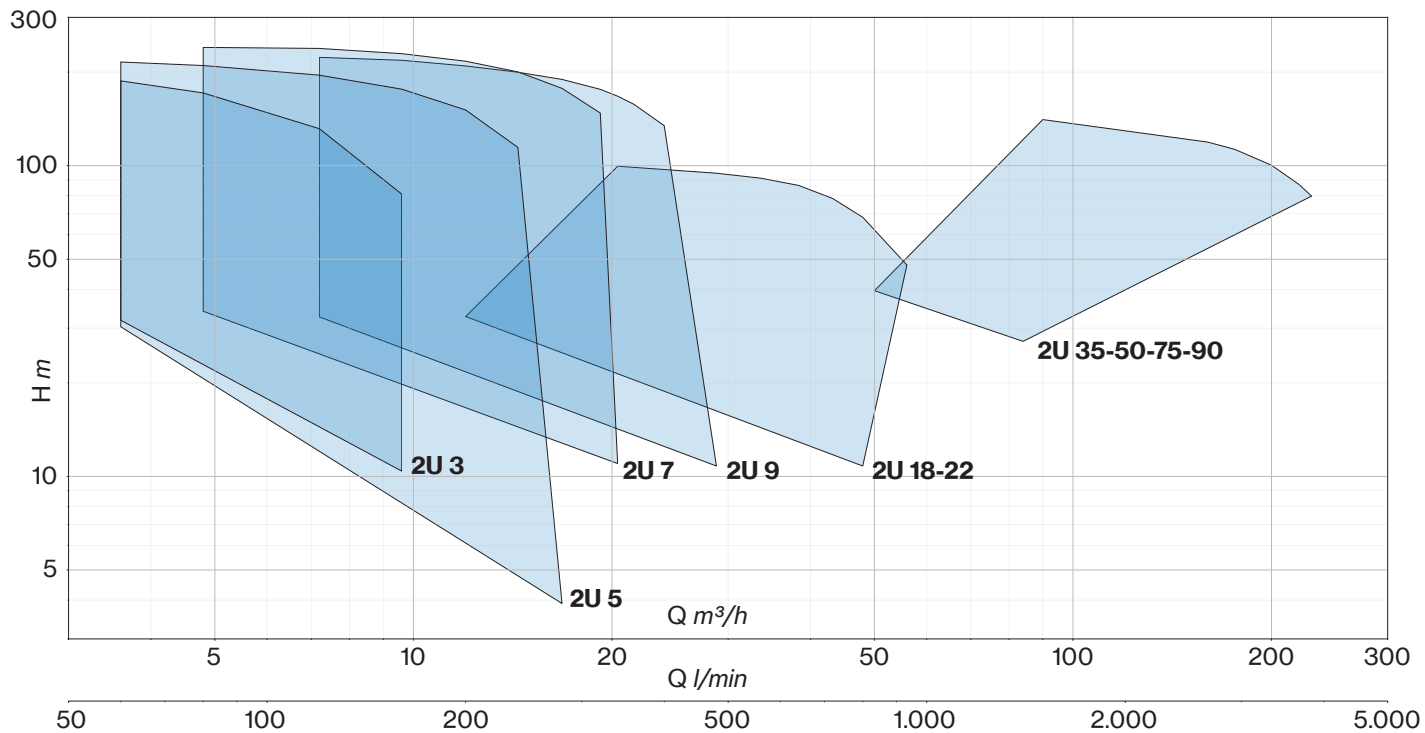

3U

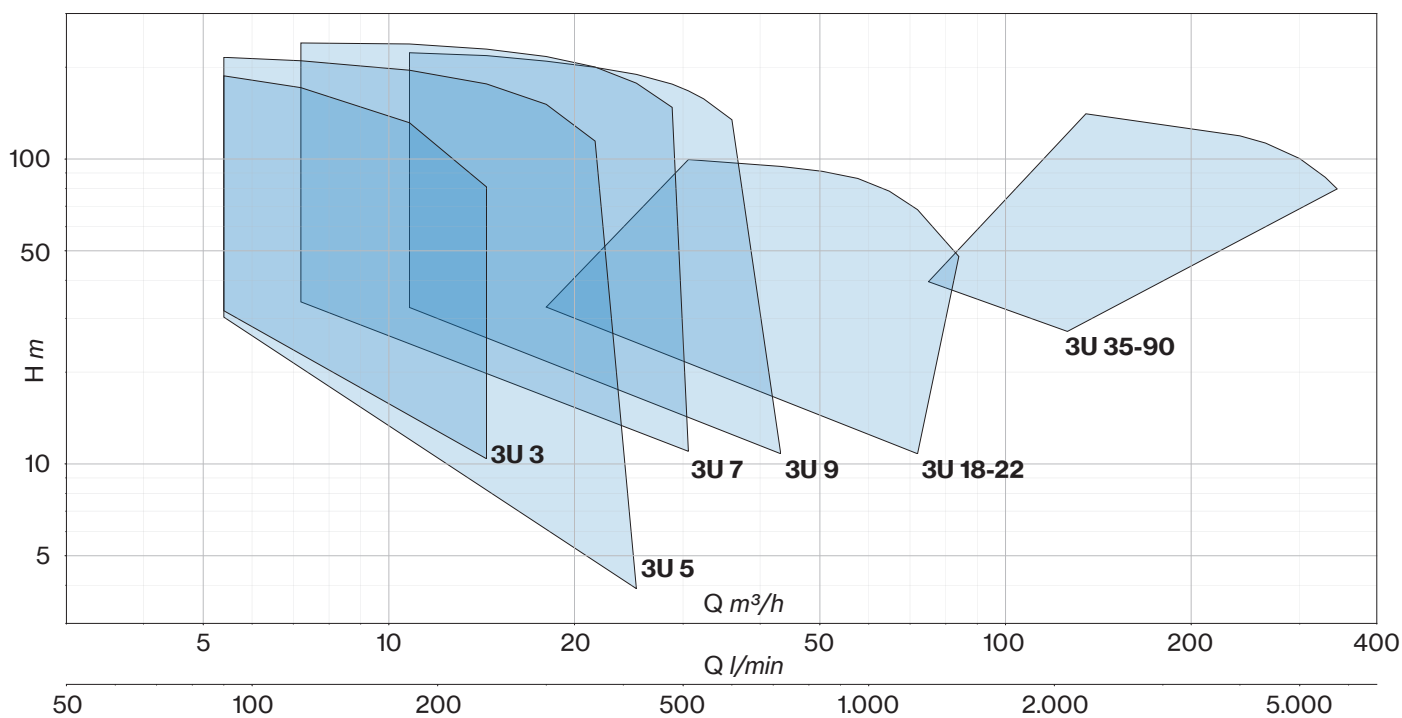

PERFORMANCE

TARGET (2 pumps)		VERSION			TYPE	P2 NOMINAL		Q (m³/h - l/min)																FIXED SPEED		VARIABLE SPEED	
		HORIZ.	VERT. OVERLAP	VERT. INLINE				0	12	14,4	16,8	19,2	20,4	21,6	24	28,8	33,6	38,4	43,2	48	56						
								0	200	240	280	320	340	360	400	480	560	640	720	800	933						
m³/h	bar				HP (x2)	kW (x2)	H (m)																1-	3-	1-	3-	
																							/E	/I	/A	/I	
36	2	2U 18 2U 18S	2U 18V 2U 18SV	2U 18L 2U 18SL	250/3	2,5	1,85	35,0	32,7	32,2	31,4	30,5	30,0	29,5	28,3	25,5	22,8	19,3	15,1	10,8	-	■	-	■	■	■	
	2,5	-	-	2U 18H	300/3	3	2,2	41,2			37,1	36,3	35,9	35,5	34,4	32,3	28,9	24,8	19,4	13,5	-	■	-	■	■	■	
	3	2U 18 2U 18S	2U 18V 2U 18SV	2U 18L 2U 18SL	400/4	4	3	47,1	45,4	45,2	44,9	44,3	44,0	43,6	42,6	40,0	36,0	30,6	24,6	17,8	-	■	-	■	■	■	
	3,5	-	-	2U 18H	400/4	4	3	55,1			49,9	48,8	48,3	47,7	46,3	43,5	39,1	33,5	26,4	18,5	-	■	-	■	■	■	
	4	-	2U 18V 2U 18SV	2U 18L 2U 18SL	450/5	4,5	3,37	59,2	57,6	57,4	57,0	56,4	56,0	55,6	54,5	51,6	46,7	40,1	33,3	25,3	-	■	-	■	■	■	
	4,5	-	-	2U 18H	550/5	5,5	4	72,3			64,3	63,1	62,4	61,7	60,1	56,6	51,8	45,1	36,8	27,6	-	■	-	■	■	■	
	5	-	2U 18V 2U 18SV	2U 18L 2U 18SL	550/6	5,5	4	71,4	69,7	69,6	69,0	68,2	67,7	67,1	65,7	62,2	56,3	48,0	39,4	29,4	-	■	-	■	■	■	
	6	-	-	2U 18H	750/6	7,5	5,5	88,0			79,6	78,2	77,4	76,7	74,9	71,0	66,0	58,3	48,8	37,5	-	■	-	■	■	■	
	6,5	-	-	2U 18H	750/7	7,5	5,5	102,5			92,4	90,7	89,8	88,9	86,8	82,3	76,2	67,3	56,1	43,0	-	■	-	■	■	■	
	7	-	2U 18V 2U 18SV	2U 18L 2U 18SL	750/8	7,5	5,5	96,1	94,2	94,1	93,5	92,4	91,7	90,9	89,1	84,5	77,0	66,1	54,2	41,1	-	■	-	■	■	■	
	7,5	-	2U 18V 2U 18SV	2U 18L 2U 18SL	900/9	10	7,5	108,5	106,9	107,0	106,4	105,3	104,5	103,7	101,7	96,8	88,6	75,9	62,6	47,8	-	■	-	■	■	■	
	8	-	-	2U 18H	1000/8	10	7,5	117,0			105,2	103,2	102,3	101,2	98,8	93,5	86,5	76,2	63,5	48,5	-	■	-	■	■	■	
	9	-	-	2U 18H	1000/9	10	7,5	131,2			117,8	115,5	114,4	113,1	110,4	104,5	96,5	84,9	70,5	53,6	-	■	-	■	■	■	
	9,5	-	-	2U 18LG	920/10	10	7,5	120,4	116,8	118,3	118,0	116,6	115,9	115,0	112,6	104,4	96,3	85,8	67,8		-	■	-	■	■	■	
10	-	-	2U 18LG	1000/11	10	7,5	132,4	128,9	130,0	129,6	128,0	127,1	125,9	123,0	115,0	103,9	93,0	72,6		-	■	-	■	■	■		
44	3	-	-	2U 22H	400/3	4	3	45,0					40,8	40,5	39,9	38,3	36,6	34,2	30,5	25,8	16,6	-	■	-	■	■	■
	4	-	-	2U 22H	550/4	5,5	4	62,2					55,5	55,1	54,2	52,4	50,2	47,3	42,7	36,8	25,2	-	■	-	■	■	■
	5	-	-	2U 22H	750/5	7,5	5,5	78,6					70,6	70,1	69,0	67,0	64,2	60,8	55,3	47,9	33,5	-	■	-	■	■	■
	6,5	-	-	2U 22H	1000/6	10	7,5	94,2					86,0	85,3	84,1	81,7	79,2	76,8	63,6	52,8	42,0	-	■	-	■	■	■
	7,5	-	-	2U 22H	1000/7	10	7,5	109,5					99,6	98,8	97,4	94,6	91,2	86,3	78,4	68,2	47,9	-	■	-	■	■	■

TARGET (2 pumps)		VERSION			TYPE	P2 NOMINAL		Q (m³/h - l/min)																FIXED SPEED		VARIABLE SPEED							
		HORIZ.	VERT. OVERLAP	VERT. INLINE				0	50	60	68	84	90	100	120	128	140	160	176	200	230												
								0	833	1000	1133	1400	1500	1667	2000	2133	2333	2667	2933	3333	3833												
m³/h	bar				HP (x2)	kW (x2)	H (m)																1-	3-	1-	3-							
																							/E	/I	/A	/I							
70	3	-	-	2U 35H	750/2	7,5	5,5	48,5	39,6	36,9	34,4	27,2														-	■	-	■	■	■		
	4,5	-	-	2U 35H	1000/3	10	7,5	72,2	58,2	54,2	50,3	39,5															-	■	-	■	■	■	
	5	-	-	2U 35H	1000/4-2R	10	7,5	85,1	68,6	63,9	58,4	44,7															-	■	-	■	■	■	
	6	-	-	2U 35H	1500/4-1R	15	11	92,8	75,3	70,2	65,2	50,8																-	■	-	■	■	■
	7	-	-	2U 35H	1500/4	15	11	99,4	81,0	76,3	71,8	58,5																-	■	-	■	■	■
	8,5	-	-	2U 35H	2000/5	20	15	121,1	99,3	93,1	87,4	70,0																-	■	-	■	■	■
	10	-	-	2U 35H	2000/6	20	15	145,6	119,3	111,9	105,0	84,2																-	■	-	■	■	■
100	3	-	-	2U 50H	1000/2	10	7,5	49,0			42,0	38,8	37,2	34,3	27,5	24,1											-	■	-	■	■	■	
	5	-	-	2U 50H	1500/3	15	11	74,2			65,0	60,9	58,8	54,8	45,5	41,0											-	■	-	■	■	■	
	7	-	-	2U 50H	2000/4	20	15	97,5			86,4	81,3	78,5	73,2	60,8	54,7											-	■	-	■	■	■	
	9	-	-	2U 50H	2500/5	25	18,5	122,3			109,1	102,9	99,5	92,9	77,5	70,0												-	■	-	■	■	■
	11	-	-	2U 50H	3000/6	30	22	146,0			129,8	122,2	118,0	110,0	91,6	82,5												-	■	-	■	■	■
150	3,5	-	-	2U 75H	1500/2	15	11	59,3		51,2	49,9	47,5	46,8	45,5	43,2	42,0	39,9	35,3	30,8								-	■	-	■	■	■	
	6	-	-	2U 75H	2500/3	25	18,5	89,6		77,6	75,6	72,0	70,9	69,0	65,7	63,9	60,7	53,9	47,2								-	■	-	■	■	■	
	8	-	-	2U 75H	3000/4	30	22	111,8		100,8	99,2	95,8	94,5	92,4	88,4	86,3	82,3	73,3	62,9								-	■	-	■	■	■	
	10	-	-	2U 75H	4000/5	40	30	142,4		129,2	127,1	123,0	121,5	119,0	114,1	111,5	106,9	96,3	84,6								-	■	-	■	■	■	
	11	-	-	2U 75H	4000/6-2R	40	30	153,5		141,6	139,5	135,1	133,3	130,3	123,4	119,6	112,9	99,0	84,1								-	■	-	■	■	■	
180	2,5	-	-	2U 90H	1500/2-2R	15	11	49,6					42,4	41,3	39,0	38,1	36,6	33,2	29,4	22,7	11,7					-	■	-	■	■	■		
	4	-	-	2U 90H	2000/2	20	15	69,2					56,6	54,5	50,5	49,2	47,3	44,3	41,6	36,3	27,3					-	■	-	■	■	■		
	6,5	-	-	2U 90H	3000/3	30	22	92,4					82,6	80,6	76,7	75,3	73,2	69,4	65,5	57,8	45,2					-	■	-	■	■	■		
	9	-	-	2U 90H	4000/4	40	30	125,6					113,0	110,4	105,2	103,3	100,6	95,7	90,7	80,8	64,4					-	■	-	■	■	■		
	11	-	-	2U 90H	5000/5	50	37	156,6					140,7	137,4	130,9	128,6	125,2	119,1	112,8	100,3	79,8					-	■	-	■	■	■		



CURVES 2U

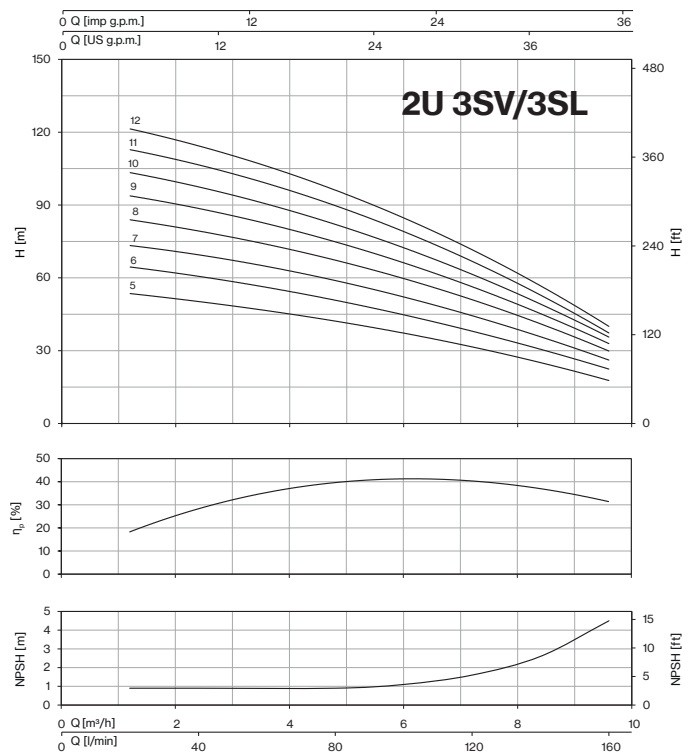
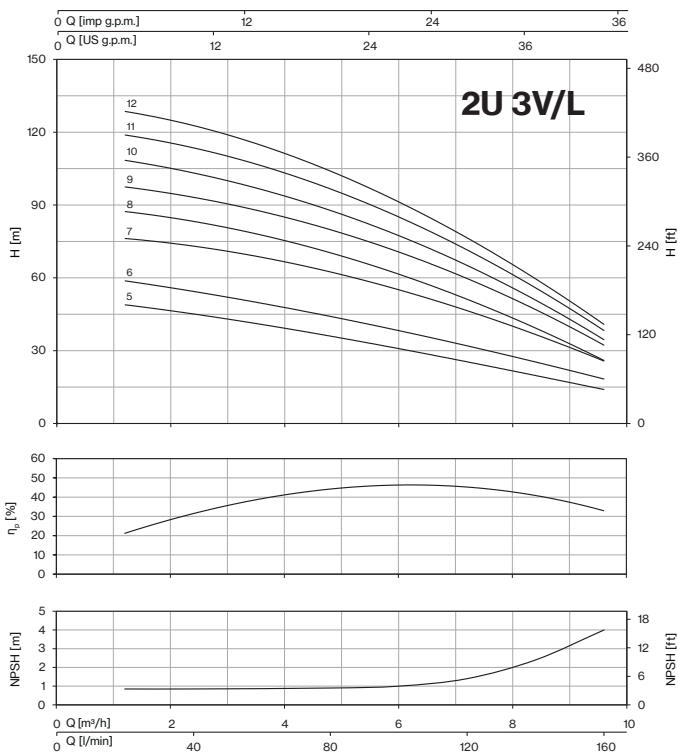
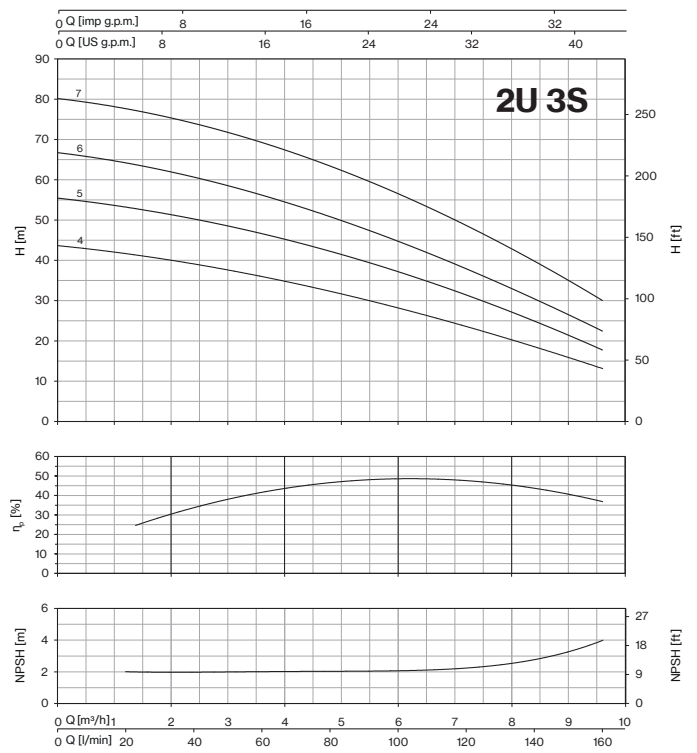
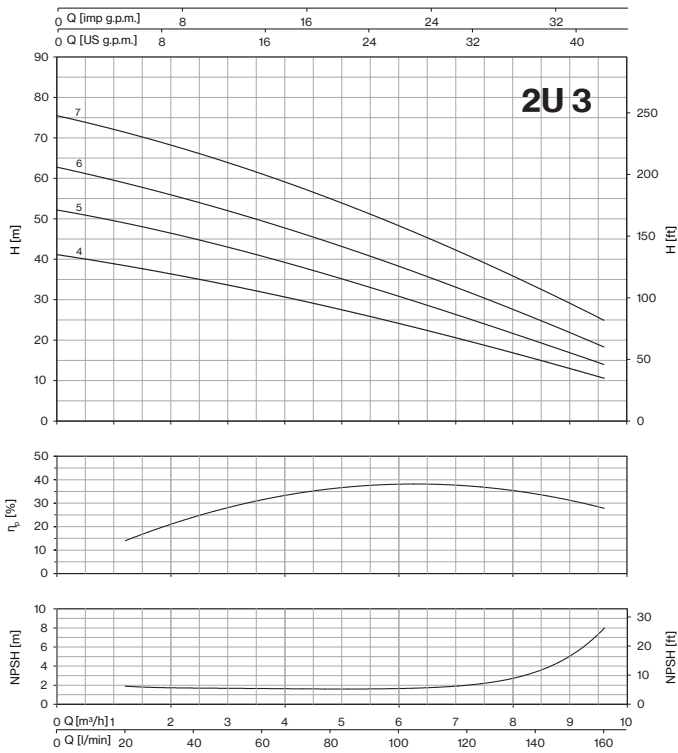

CURVES 2U

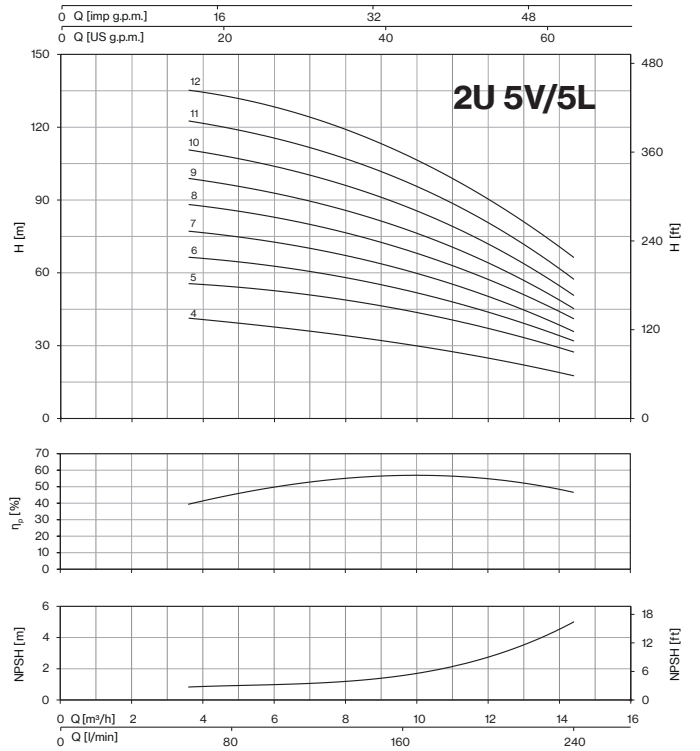
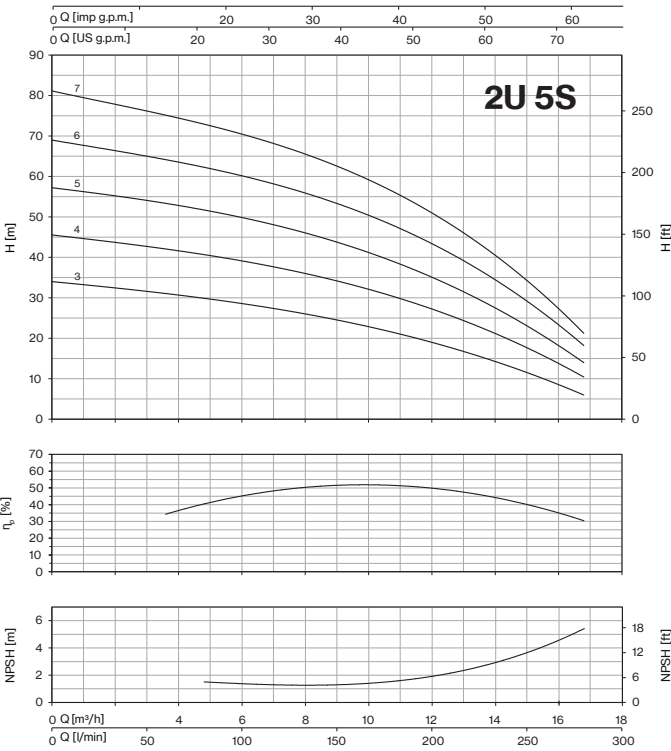
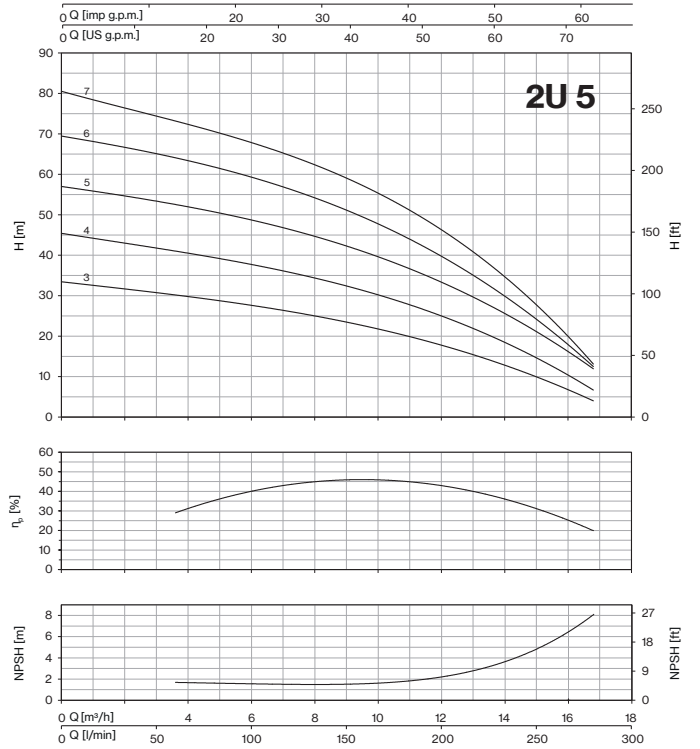
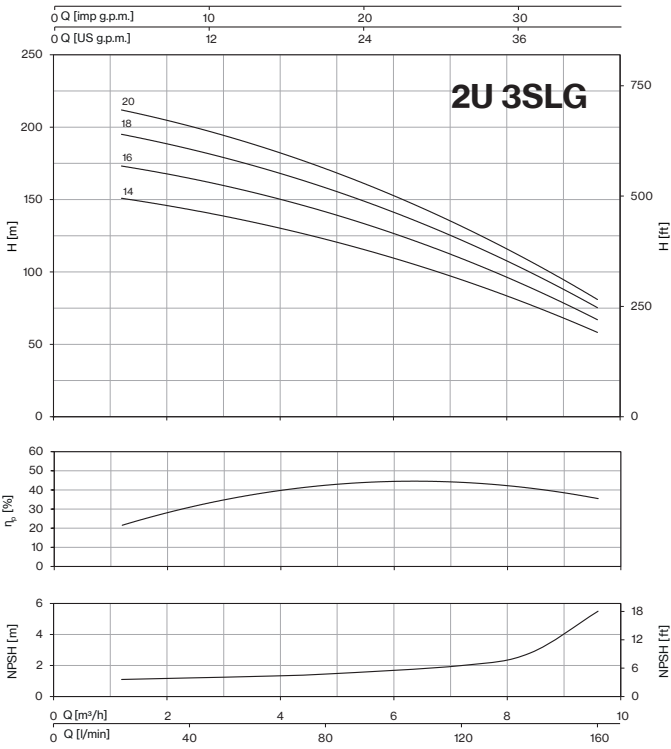

CURVES 2U

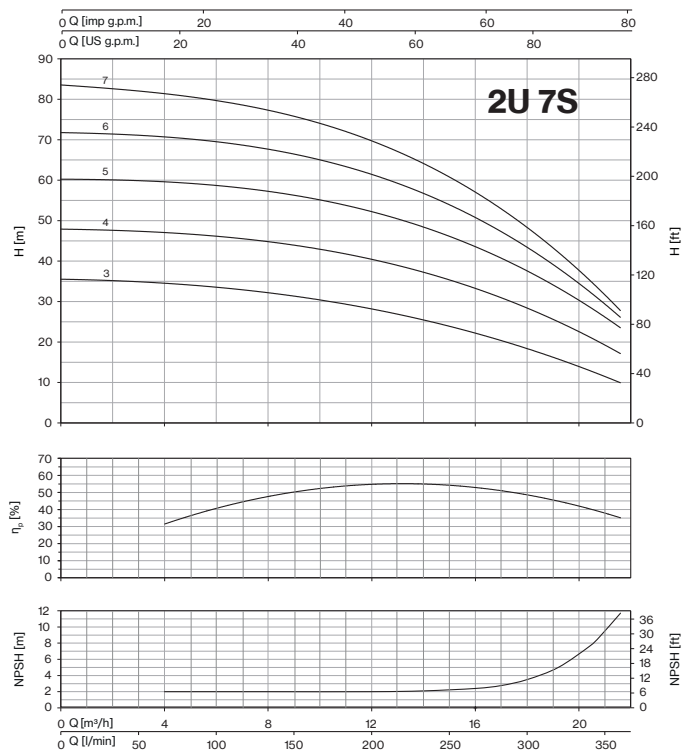
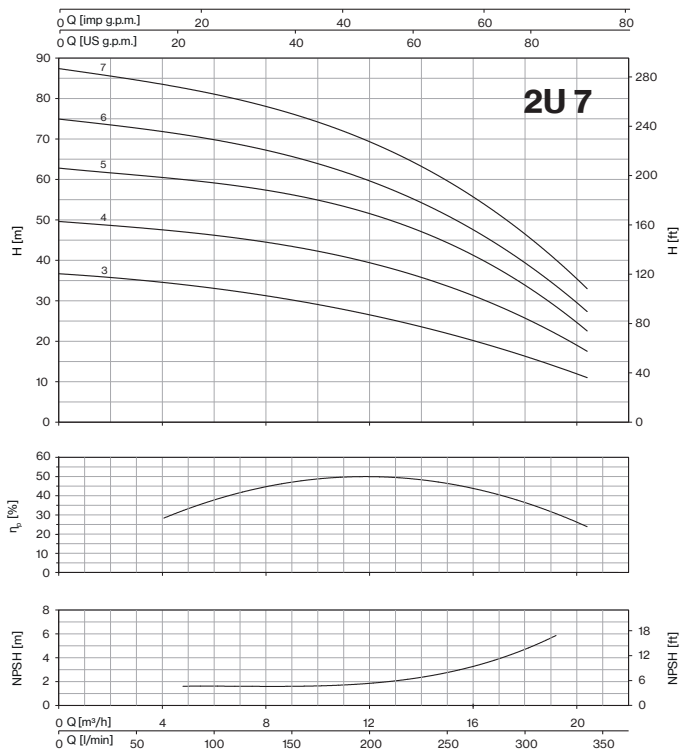
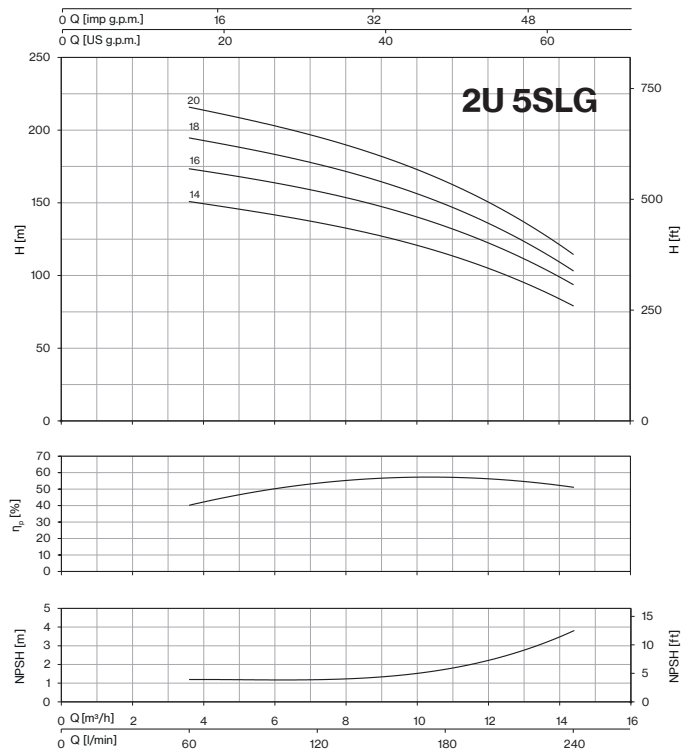
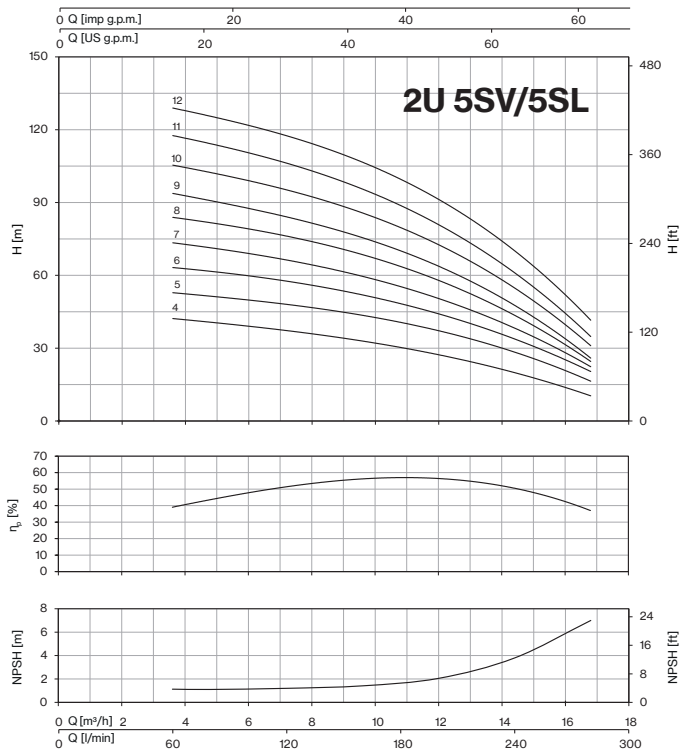

CURVES 2U

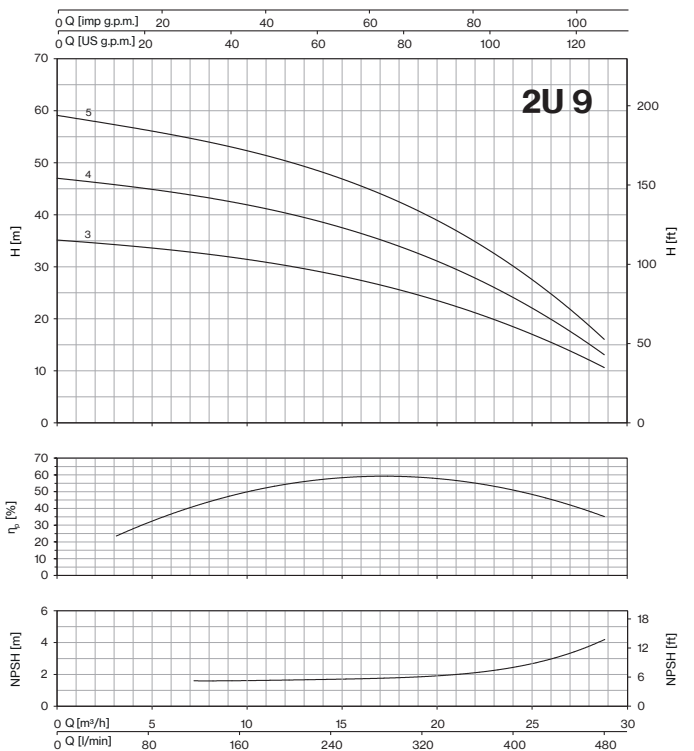
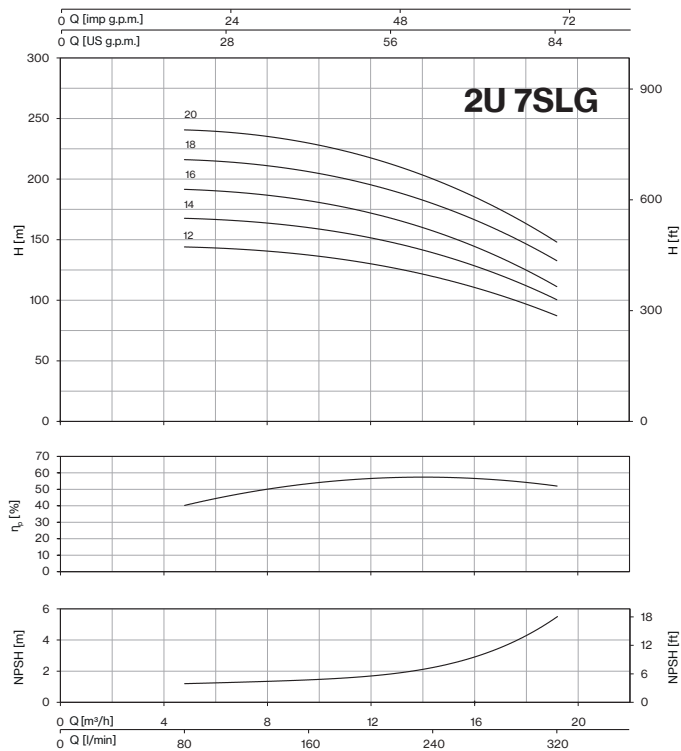
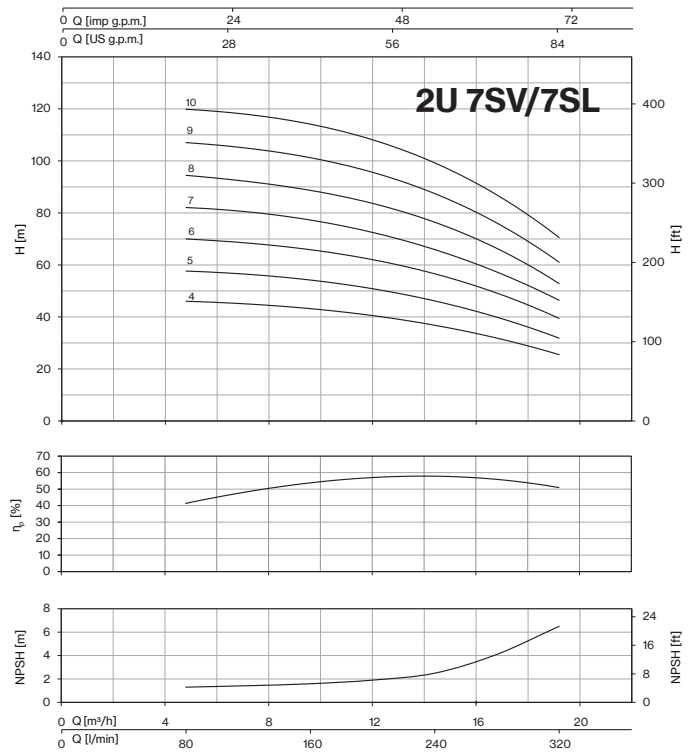
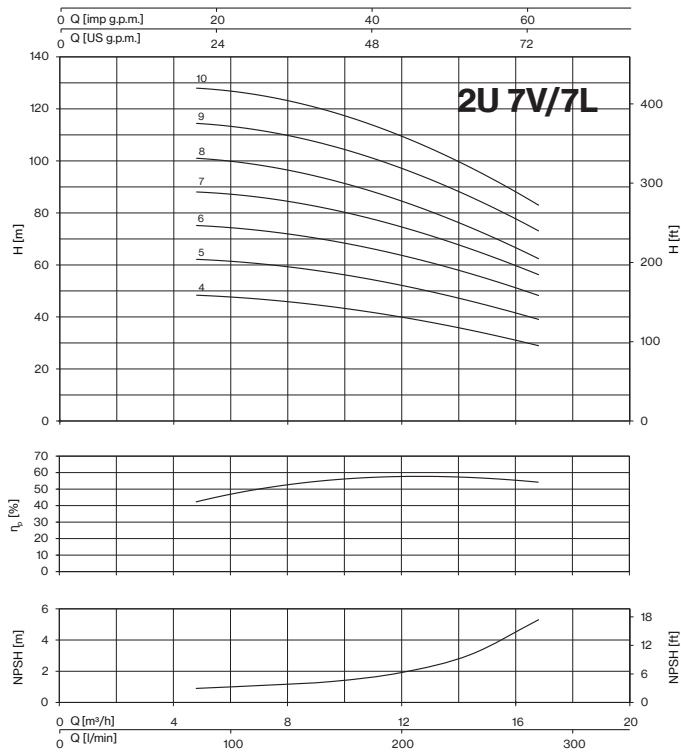

CURVES 2U

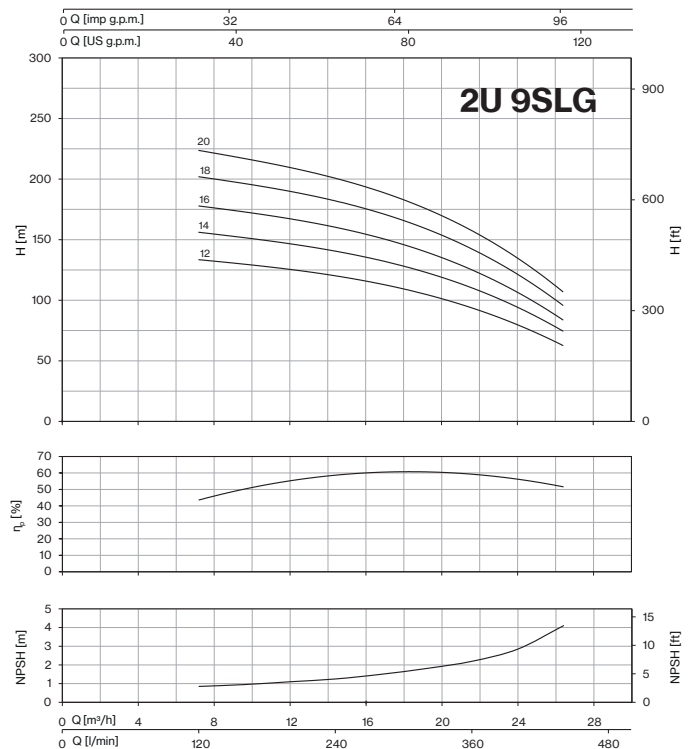
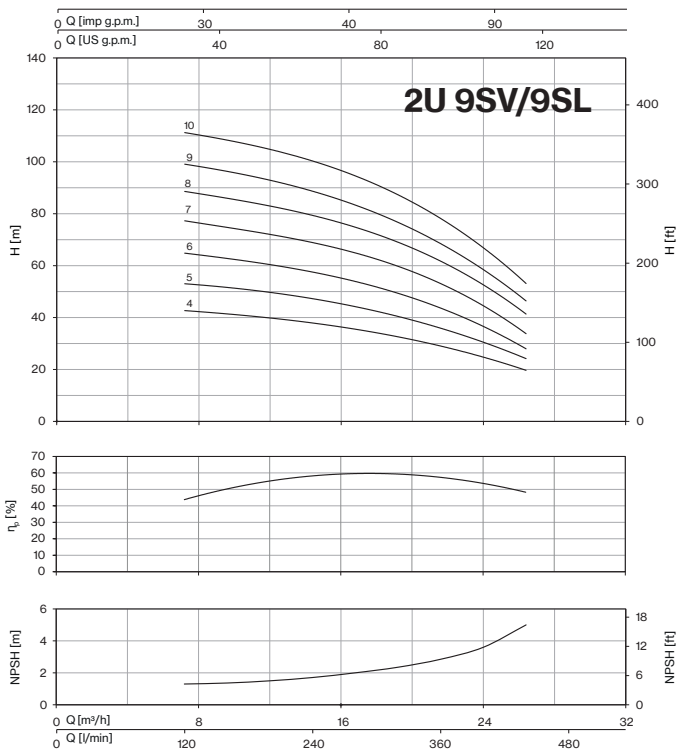
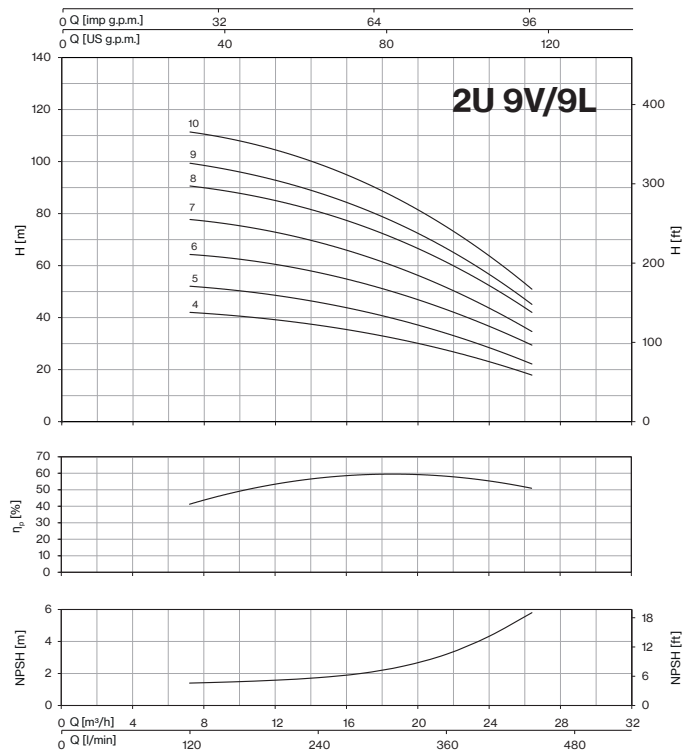
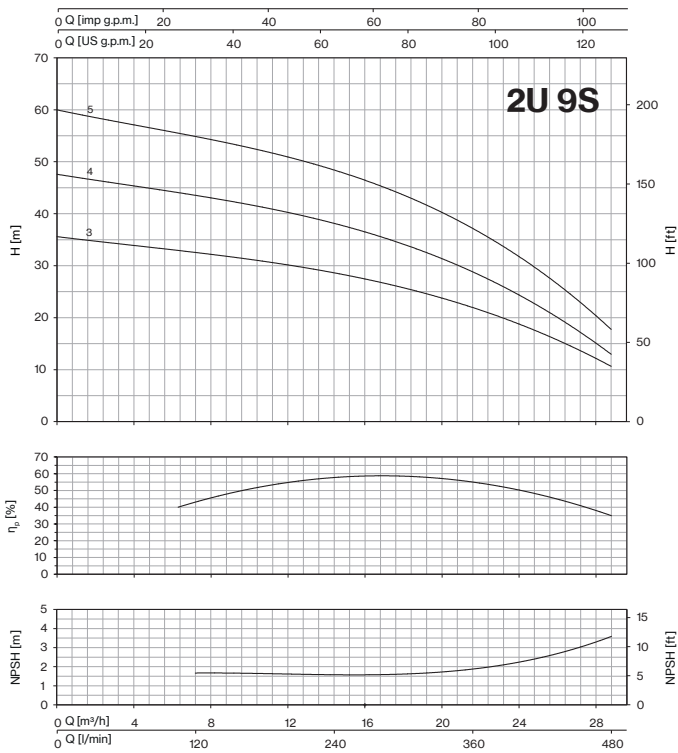

CURVES 2U

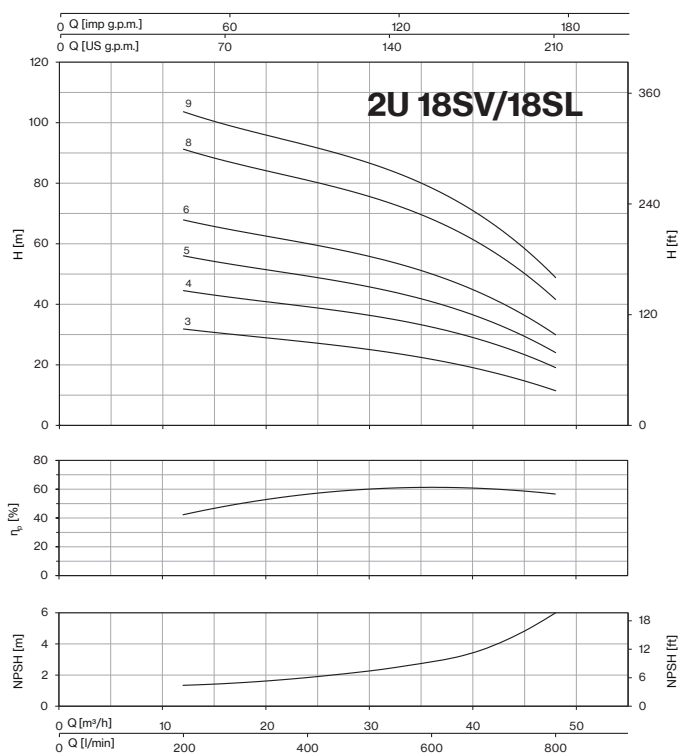
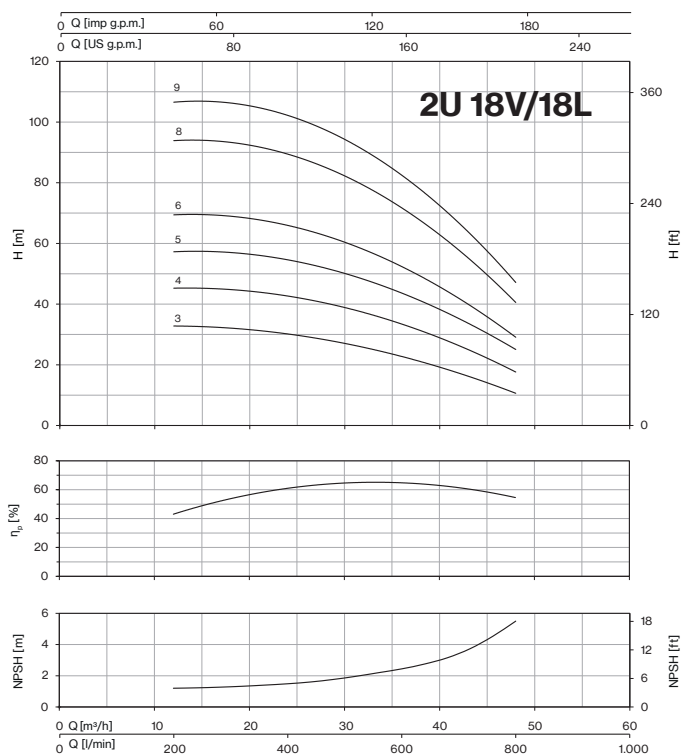
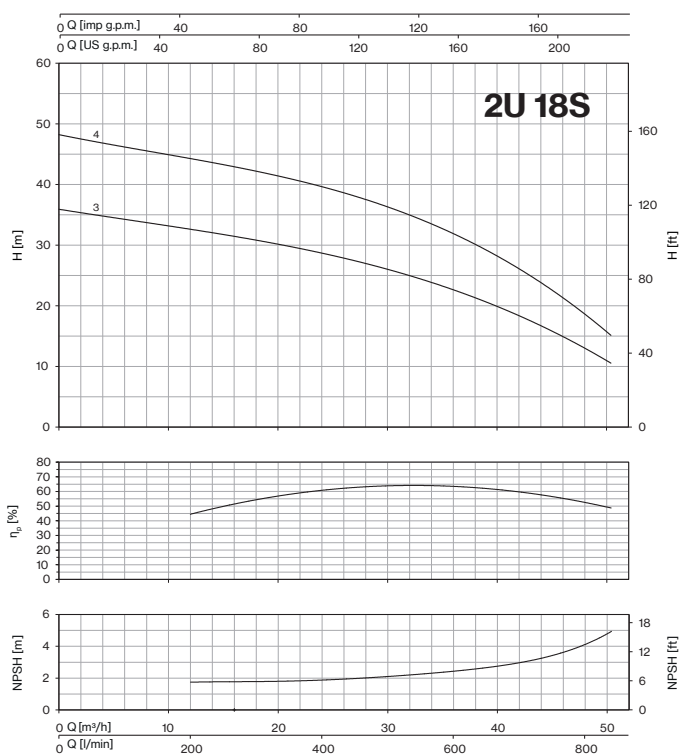
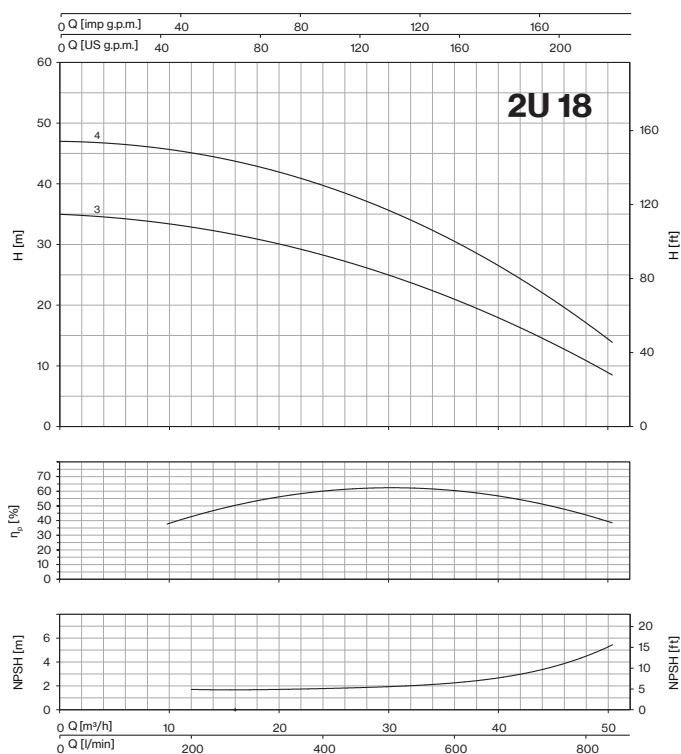

CURVES 2U

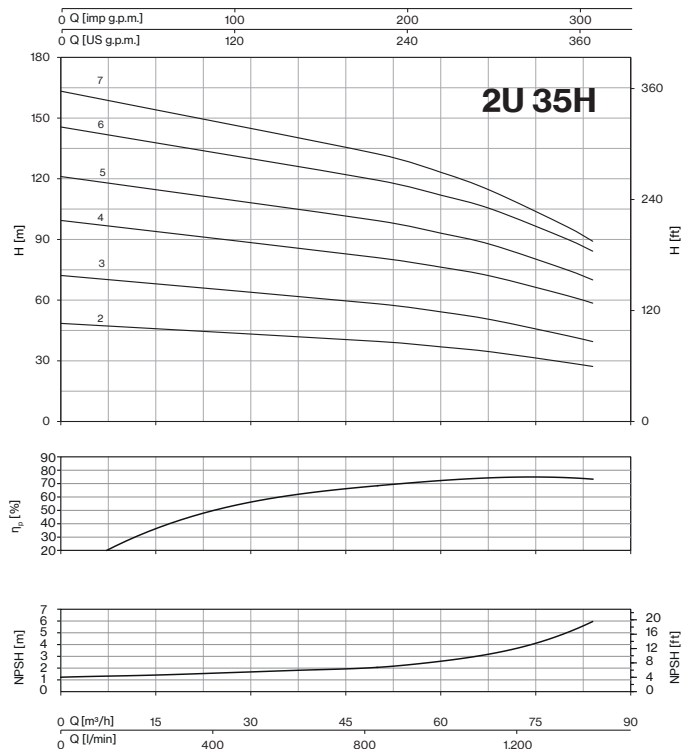
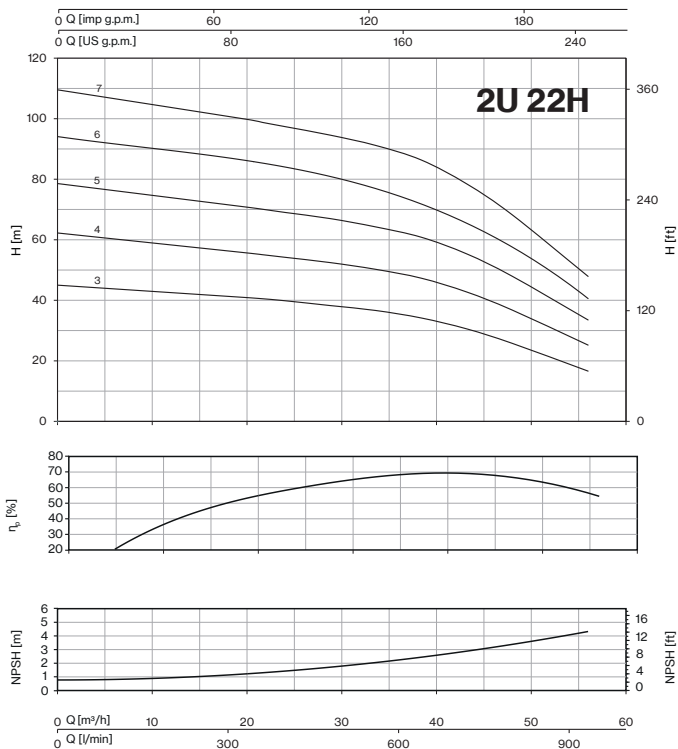
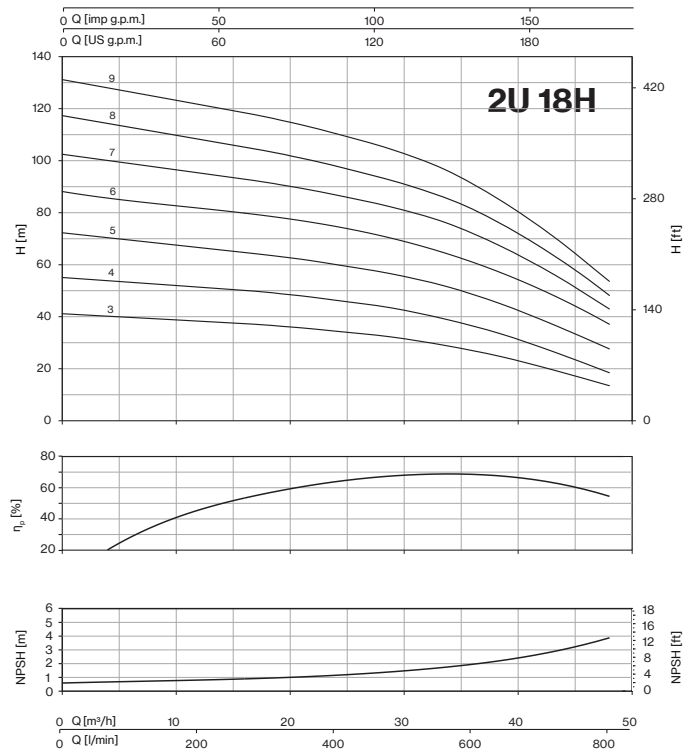
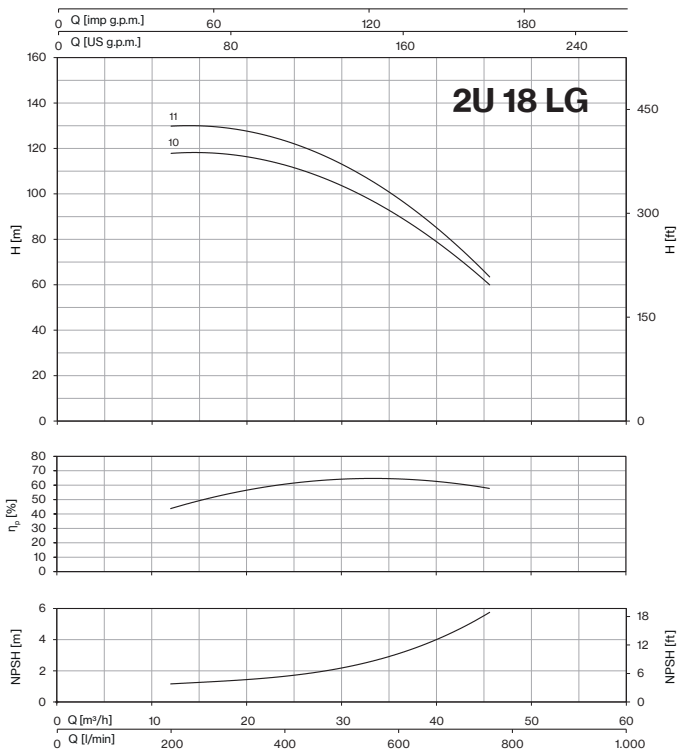

CURVES 2U

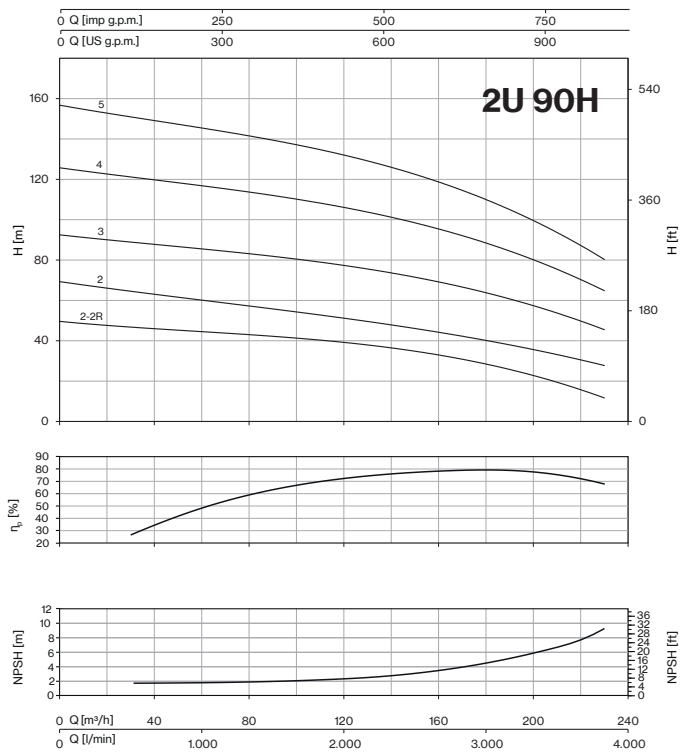
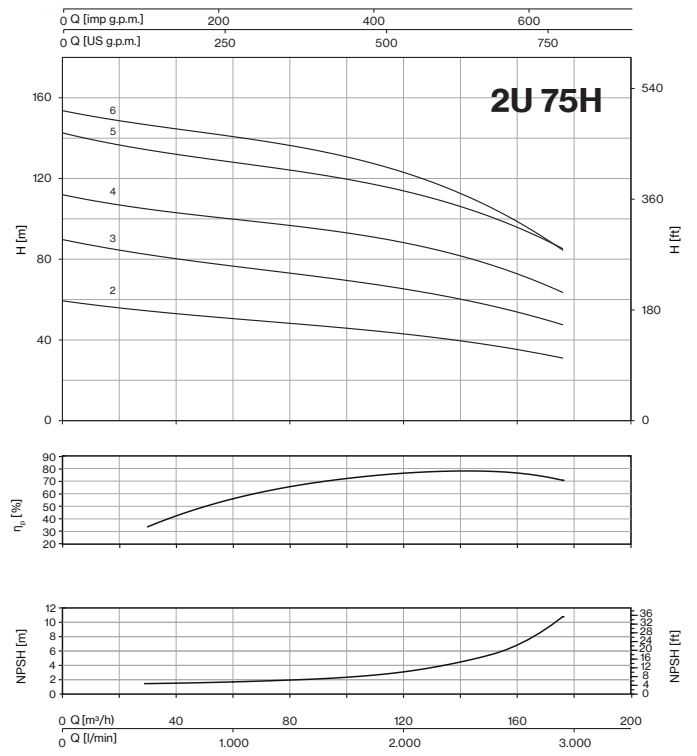
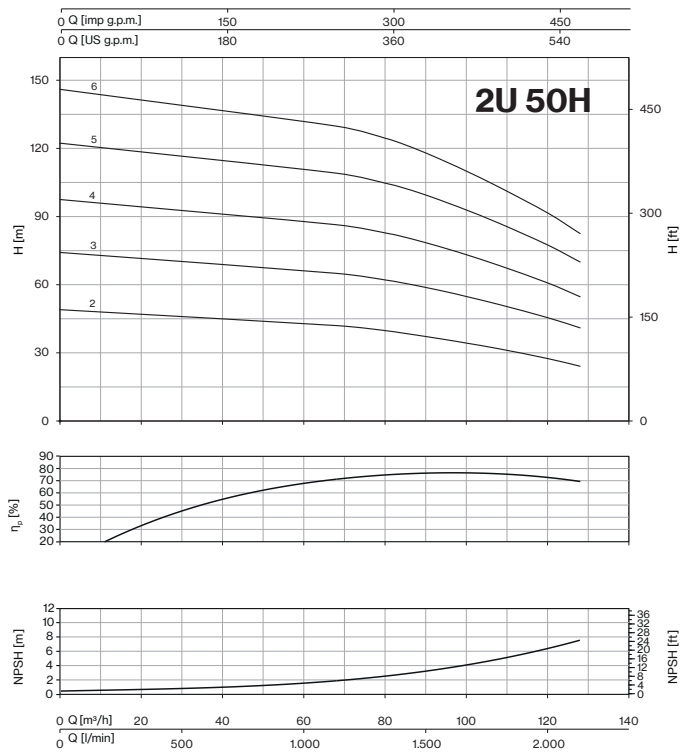

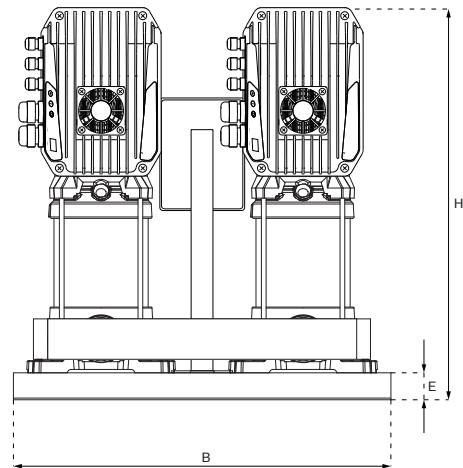
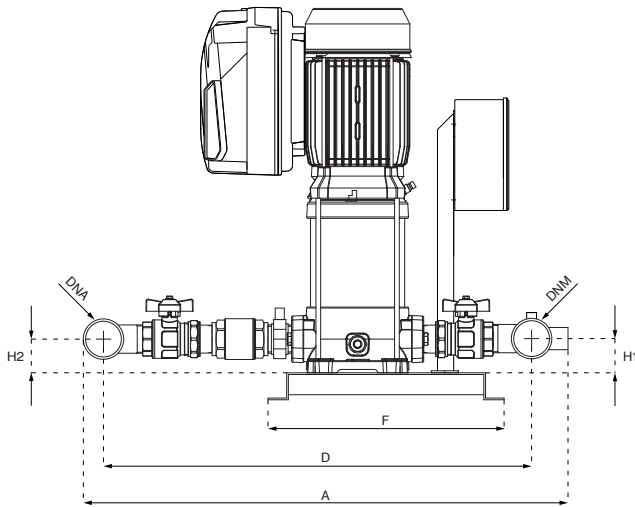

VERTICAL MODEL L		P1	In		Required tank	DIMENSIONS										Kg
EPIC	EPIC-A		3- 230V	3- 400V		A	B	D	E	F	H	H1	H2	DNA	DNM	
1- 230V-in 3- 230V-out	3- 400V-in 3- 400V-out	kW (x2)	A (x2)		Lt	mm										
2U 3L/E-100/5T	2U 3L/A-100/5T-304	1,01	3,3	1,9	2x 8	700	560	615	40	350	469	50	50	2" G	1" 1/2 G	62
2U 3SL/E-100/5T	2U 3SL/A-100/5T-304	0,92	2,9	1,7	2x 8	700	560	615	40	350	493	50	50			67
2U 3L/E-120/6T	2U 3L/A-120/6T-304	1,23	4,5	2,6	2x 8	700	560	615	40	350	493	50	50			71
2U 3SL/E-120/6T	2U 3SL/A-120/6T-304	1,11	4,3	2,5	2x 8	700	560	615	40	350	577	50	50			72
2U 3L/E-150/7T	2U 3L/A-150/7T-304	1,45	5	2,9	2x 8	700	560	615	40	350	601	50	50			73
2U 3SL/E-150/7T	2U 3SL/A-150/7T-304	1,31	4,7	2,7	2x 8	700	560	615	40	350	625	50	50			80
2U 3L/E-180/8T	2U 3L/A-180/8T-304	1,6	5,2	3	2x 8	700	560	615	40	350	649	50	50			81
2U 3SL/E-180/8T	2U 3SL/A-180/8T-304	1,55	4,7	2,7	2x 8	700	560	615	40	350	673	50	50			83
2U 3L/E-200/9T	2U 3L/A-200/9T-304	1,8	5,7	3,3	2x 8	700	560	615	40	350	697	50	50			120
2U 3SL/E-200/9T	2U 3SL/A-200/9T-304	1,6	5,2	3	2x 8	700	560	615	40	350	1017	75	75			128
2U 3L/E-250/10T	2U 3L/A-250/10T-306	2	7,1	4,1	2x 8	700	560	615	40	350	1065	75	75			132
2U 3SL/E-250/10T	2U 3SL/A-250/10T-306	1,8	6,4	3,7	2x 8	700	560	615	40	350	1138	75	75			148
-	2U 3L/A-280/11T-306	2,2	-	4,3	2x 8	700	560	615	40	350	972	75	75			74
2U 3SL/E-280/11T	2U 3SL/A-280/11T-306	2	6,8	3,9	2x 8	700	560	615	40	350	1017	75	75			77
-	2U 3L/A-300/12T-306	2,44	-	4,7	2x 8	700	560	615	40	350	1065	75	75	79		
-	2U 3SL/A-300/12T-306	2,2	-	4,3	2x 8	700	560	615	40	350	1138	75	75	81		
-	2U 3SLG/A-350/14T-306	2,5	-	4,7	2x 8	815	560	730	40	350	1017	75	75	85		
-	2U 3SLG/A-380/16T-309	2,9	-	5,5	2x 8	815	560	730	40	350	1065	75	75			
-	2U 3SLG/A-400/18T-309	3,2	-	6	2x 8	815	560	730	40	350	1138	75	75			
-	2U 3SLG/A-450/20T-309	3,6	-	6,5	2x 8	815	560	730	40	350						
2U 5L/E-120/4T	2U 5L/A-120/4T-304	1,13	4,3	2,5	2x 20	700	560	615	40	350	445	50	50	2" G	1" 1/2 G	67
2U 5SL/E-120/4T	2U 5SL/A-120/4T-304	1,08	4,2	2,4	2x 20	700	560	615	40	350	529	50	50			71
2U 5L/E-150/5T	2U 5L/A-150/5T-304	1,39	4,9	2,8	2x 20	700	560	615	40	350	553	50	50			72
2U 5SL/E-150/5T	2U 5SL/A-150/5T-304	1,31	4,7	2,7	2x 20	700	560	615	40	350	577	50	50			74
2U 5L/E-180/6T	2U 5L/A-180/6T-304	1,62	5,2	3	2x 20	700	560	615	40	350	601	50	50			77
2U 5SL/E-180/6T	2U 5SL/A-180/6T-304	1,55	5,2	3	2x 20	700	560	615	40	350	625	50	50			79
2U 5L/E-200/7T	2U 5L/A-200/7T-304	1,86	5,9	3,4	2x 20	700	560	615	40	350	649	50	50			81
2U 5SL/E-200/7T	2U 5SL/A-200/7T-304	1,77	5,7	3,3	2x 20	700	560	615	40	350	727	50	50			85
2U 5L/E-250/8T	2U 5L/A-250/8T-306	2,17	7,1	4,1	2x 20	700	560	615	40	350						
2U 5SL/E-250/8T	2U 5SL/A-250/8T-306	2,07	6,9	4	2x 20	700	560	615	40	350						
-	2U 5L/A-280/9T-306	2,4	-	4,4	2x 20	700	560	615	40	350						
2U 5SL/E-280/9T	2U 5SL/A-280/9T-306	2,27	7,3	4,2	2x 20	700	560	615	40	350						
-	2U 5L/A-300/10T-306	2,73	-	4,9	2x 20	700	560	615	40	350						
-	2U 5SL/A-300/10T-306	2,57	-	4,7	2x 20	700	560	615	40	350						
-	2U 5L/A-350/11T-306	2,9	-	5,3	2x 20	700	560	615	40	350						
-	2U 5SL/A-350/11T-306	2,9	-	5,3	2x 20	700	560	615	40	350						

Dimensions and weights may differ slightly and therefore should be considered as indicative



2U L

Variable speed EPIC and EPIC-A

VERTICAL MODEL L		P1	In		Required tank	DIMENSIONS											Kg
EPIC	EPIC-A		3~ 230V	3~ 400V		A	B	D	E	F	H	H1	H2	DNA	DNM		
1~ 230V-in 3~ 230V-out	3~ 400V-in 3~ 400V-out															kW (x2)	
-	2U 5L/A-380/12T-309	3,2	-	6	2x 20	700	560	615	40	350	751	50	50	2" G	1" 1/2 G	98	
-	2U 5SL/A-380/12T-309	3,2	-	6	2x 20	700	560	615	40	350	751	50	50			125	
-	2U 5SLG/A-400/14T-309	3,5	-	6,3	2x 20	815	560	730	40	350	972	75	75			149	
-	2U 5SLG/A-450/16T-309	4,1	-	7,9	2x 20	815	560	730	40	350	1040	75	75			170	
-	2U 5SLG/A-550/18T-314	4,5	-	8,3	2x 20	815	560	730	40	350	1088	75	75			173	
-	2U 5SLG/A-600/20T-314	5	-	8,9	2x 20	815	560	730	40	350	1138	75	75			173	
2U 7L/E-180/4T	2U 7L/A-180/4T-304	1,71	5,5	3,2	2x 20	760	560	670	40	350	505	50	50	2" 1/2 G	2" G	78	
2U 7SL/E-180/4T	2U 7SL/A-180/4T-304	1,62	5,4	3,1	2x 20	760	560	670	40	350	505	50	50			83	
2U 7L/E-250/5T	2U 7L/A-250/5T-306	2,15	7,3	4,2	2x 20	760	560	670	40	350	529	50	50			85	
2U 7L/E-250/5T	2U 7L/A-250/5T-306	2,05	7,1	4,1	2x 20	760	560	670	40	350	529	50	50			98	
-	2U 7L/A-300/6T-306	2,63	-	5	2x 20	760	560	670	40	350	553	50	50			102	
-	2U 7SL/A-300/6T-306	2,44	-	4,8	2x 20	760	560	670	40	350	553	50	50			111	
-	2U 7L/A-350/7T-306	2,8	-	5,1	2x 20	760	560	670	40	350	630	50	50			130	
-	2U 7SL/A-350/7T-306	2,9	-	5,3	2x 20	760	560	670	40	350	630	50	50			187	
-	2U 7L/A-400/8T-309	3,1	-	5,9	2x 20	760	560	670	40	350	654	50	50			185	
-	2U 7SL/A-400/8T-309	3,3	-	6,1	2x 20	760	560	670	40	350	654	50	50			199	
-	2U 7L/A-450/9T-309	3,6	-	6,5	2x 20	760	560	670	40	350	708	50	50			216	
-	2U 7SL/A-450/9T-309	3,7	-	6,7	2x 20	760	560	670	40	350	708	50	50			218	
-	2U 7L/A-550/10T-309	4	-	7,7	2x 20	760	560	670	40	350	732	50	50				
-	2U 7SL/A-550/10T-309	4,1	-	7,9	2x 20	760	560	670	40	350	732	50	50				
-	2U 7SLG/A-750/12T-314	5,1	-	9,9	2x 20	875	560	785	40	350	980	75	75				
-	2U 7SLG/A-800/14T-314	5,9	-	10,9	2x 20	875	560	785	40	350	1028	75	75				
-	2U 7SLG/A-900/16T-314	6,7	-	12	2x 20	875	560	785	40	350	1076	75	75				
-	2U 7SLG/A-950/18T-314	7,4	-	12,4	2x 20	875	560	785	40	350	1121	75	75				
-	2U 7SLG/A-1000/20T-318	8,2	-	13,5	2x 20	875	560	785	40	350	1168	75	75				
2U 9L/E-200/4T	2U 9L/A-200/4T-304	1,77	5,7	3,3	2x 20	780	560	670	40	350	560	80	80	2" 1/2 G	2" G	85	
2U 9SL/E-200/4T	2U 9SL/A-200/4T-304	1,77	5,7	3,3	2x 20	780	560	670	40	350	560	80	80			88	
-	2U 9L/A-250/5T-306	2,18	-	4,3	2x 20	780	560	670	40	350	590	80	80			90	
-	2U 9SL/A-250/5T-306	2,23	-	4,3	2x 20	780	560	670	40	350	590	80	80			110	
-	2U 9L/A-300/6T-306	2,64	-	4,8	2x 20	780	560	670	40	350	620	80	80			118	
-	2U 9SL/A-300/6T-306	2,58	-	4,9	2x 20	780	560	670	40	350	620	80	80			121	
-	2U 9L/A-400/7T-309	3	-	5,8	2x 20	780	560	670	40	350	703	80	80			148	
-	2U 9SL/A-400/7T-309	3,1	-	5,9	2x 20	780	560	670	40	350	703	80	80			185	
-	2U 9L/A-450/8T-309	3,5	-	6,4	2x 20	780	560	670	40	350	763	80	80			192	
-	2U 9SL/A-450/8T-309	3,6	-	6,5	2x 20	780	560	670	40	350	763	80	80			207	
-	2U 9L/A-500/9T-309	3,9	-	6,9	2x 20	780	560	670	40	350	803	80	80			223	
-	2U 9SL/A-500/9T-309	4	-	7	2x 20	780	560	670	40	350	803	80	80			227	
-	2U 9L/A-550/10T-309	4,3	-	8,1	2x 20	780	560	670	40	350	823	80	80				
-	2U 9SL/A-550/10T-314	4,4	-	8,2	2x 20	780	560	670	40	350	823	80	80				
-	2U 9SLG/A-750/12T-314	5,3	-	10,1	2x 20	885	560	795	40	350	1067	80	80				
-	2U 9SLG/A-800/14T-314	6,1	-	11,1	2x 20	885	560	795	40	350	1128	80	80				
-	2U 9SLG/A-900/16T-318	6,9	-	12,8	2x 20	885	560	795	40	350	1187	80	80				
-	2U 9SLG/A-950/18T-318	7,6	-	12,7	2x 20	885	560	795	40	350	1245	80	80				
-	2U 9SLG/A-1000/20T-318	8,5	-	13,9	2x 20	885	560	795	40	350	1303	80	80				
-	2U 18L/A-250/3T-306	2,19	7,5	4,3	1x 80	850	620	750	40	350	522	90	90	3" G	2" 1/2 G	99	
-	2U 18SL/A-250/3T-306	2,29	7,6	4,4	1x 80	850	620	750	40	350	522	90	90			115	
-	2U 18L/A-400/4T-309	3	-	5,8	1x 80	850	620	750	40	350	643	90	90			126	
-	2U 18SL/A-400/4T-309	3,1	-	5,9	1x 80	850	620	750	40	350	643	90	90			154	
-	2U 18L/A-450/5T-309	3,9	-	6,9	1x 80	850	620	750	40	350	720	90	90			172	
-	2U 18SL/A-450/5T-309	3,9	-	6,9	1x 80	850	620	750	40	350	720	90	90			183	
-	2U 18L/A-550/6T-314	4,6	-	8,4	1x 80	850	620	750	40	350	758	90	90			188	
-	2U 18SL/A-550/6T-314	4,7	-	8,5	1x 80	850	620	750	40	350	758	90	90			204	
-	2U 18L/A-750/8T-314	6,2	-	11,2	1x 80	850	620	750	40	350	895	90	90				
-	2U 18SL/A-750/8T-314	6,2	-	11,2	1x 80	850	620	750	40	350	895	90	90				
-	2U 18L/A-900/9T-318	6,9	-	12,8	1x 80	850	620	750	40	350	933	90	90				
-	2U 18SL/A-900/9T-318	7	-	12,9	1x 80	850	620	750	40	350	933	90	90				
-	2U 18LG/A-920/10T-318	7,7	-	14	1x 80	850	620	750	40	350	1059	90	90				
-	2U 18LG/A-1000/11T-318	8,3	-	13,6	1x 80	850	620	750	40	350	1097	90	90				



2U H (18-22)

Variable speed EPIC-A

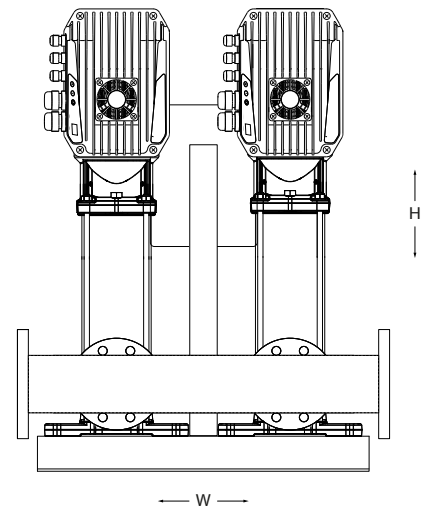
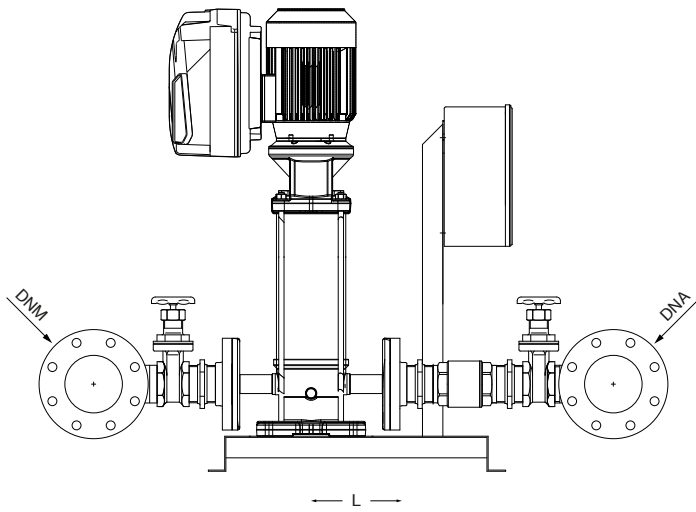

VERTICAL MODEL H (18-22) EPIC-A 3~ 400V-in 3~ 400V-out	P1	In	Required tank	DIMENSIONS					Kg
				L	W	H	DNA	DNM	
				mm					
2U 18HX/A-300/3T-306	2,31	4,2	1× 80	1000	700	800	3" G	2" ½ G	139
2U 18HX/A-400/4T-306	3,2	5,1	1× 80	1000	700	890			159
2U 18HX/A-550/5T-309	4,3	7,6	1× 80	1000	700	980			178
2U 18HX/A-750/6T-314	5	8,4	1× 80	1000	700	1070			282
2U 18HX/A-750/7T-314	5,8	9,5	1× 80	1000	700	1120			284
2U 18HX/A-1000/8T-314	6,5	11,3	1× 80	1000	700	1200			293
2U 18HX/A-1000/9T-314	7,3	12,3	1× 80	1000	700	1250	296		
2U 22HX/A-400/3T-306	3,3	5,3	1× 80	1000	800	1000	DN100	DN80	157
2U 22HX/A-550/4T-309	4,6	8,1	1× 80	1000	800	1050			175
2U 22HX/A-750/5T-314	5,9	9,5	1× 80	1000	800	1190			279
2U 22HX/A-1000/6T-314	6,7	11,4	1× 80	1000	800	1250			288
2U 22HX/A-1000/7T-318	7,7	12,8	1× 80	1000	800	1290			290



2U H (35-50-75-90)

Variable speed EPIC-A

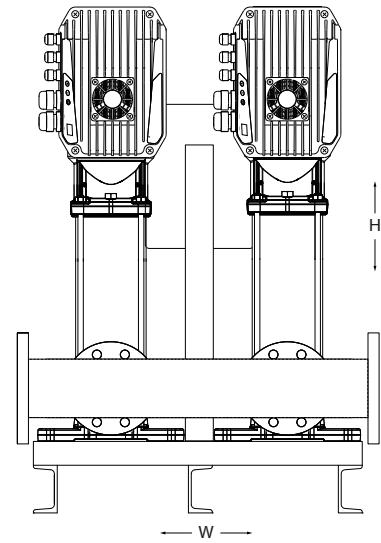
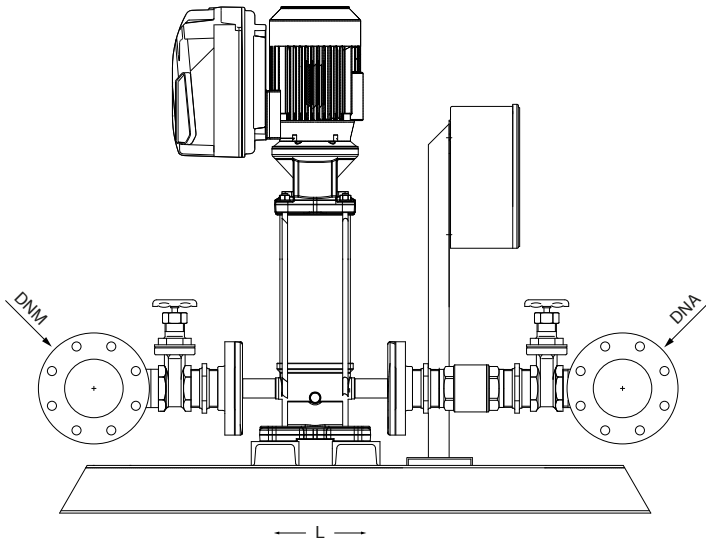

VERTICAL MODEL H (35÷90) EPIC-A 3~ 400V-in 3~ 400V-out	P1	In 3- 230V	Required tank Lt	DIMENSIONS					Kg
				L	W	H	DNA	DNM	
	kW (x2)	A (x2)	mm						
2U 35HS/A-750/2T-314	5,0	8,3	1× 100	1150	820	1550	DN100	DN100	477
2U 35HS/A-1000/3T-314	7,2	12,2	1× 100	1150	820	1550			498
2U 35HS/A-1000/4-2RT-318	8,5	13,7	1× 100	1150	820	1550			508
2U 35HS/A-1200/4-1RT-318	9,4	15,5	1× 100	1150	820	1550			518
2U 35HS/A-1500/4T-325	10,1	16,6	1× 100	1150	820	1550			518
2U 35HS/A-2000/5T-325	12,1	19,4	1× 100	1150	820	1669			558
2U 35HS/A-2000/6T-330	14,4	24,0	1× 100	1150	820	1760			598
2U 35HS/A-2000/7-1RT-330	16,1	26,4	1× 100	1150	820	1860	618		
2U 50HS/A-1000/2T-318	7,7	12,7	1× 200	1450	900	1520	DN125	DN125	498
2U 50HS/A-1500/3T-325	11,5	18,6	1× 200	1450	900	1520			518
2U 50HS/A-2000/4T-330	15,1	24,9	1× 200	1450	900	1520			598
2U 50HS/A-2500/5T-338	19	31,7	1× 200	1450	900	1700			620
2U 50HS/A-3000/6T-344	22,4	37,0	1× 200	1450	900	1790			670
2U 75HS/A-1500/2T-325	11,6	18,7	1× 200	1450	900	1520	DN150	DN150	550
2U 75HS/A-2500/3T-338	17,4	29,4	1× 200	1450	900	1520			560
2U 75HS/A-3000/4T-344	22,7	37,5	1× 200	1450	900	1690			580
2U 90HS/A-1500/2-2RT-325	11,0	17,9	1× 300	1640	950	1530	DN200	DN200	570
2U 90HS/A-2000/2T-330	15,4	25,4	1× 300	1640	950	1530			590
2U 90HS/A-3000/3T-344	22,9	37,8	1× 300	1640	950	1650			820