

2U

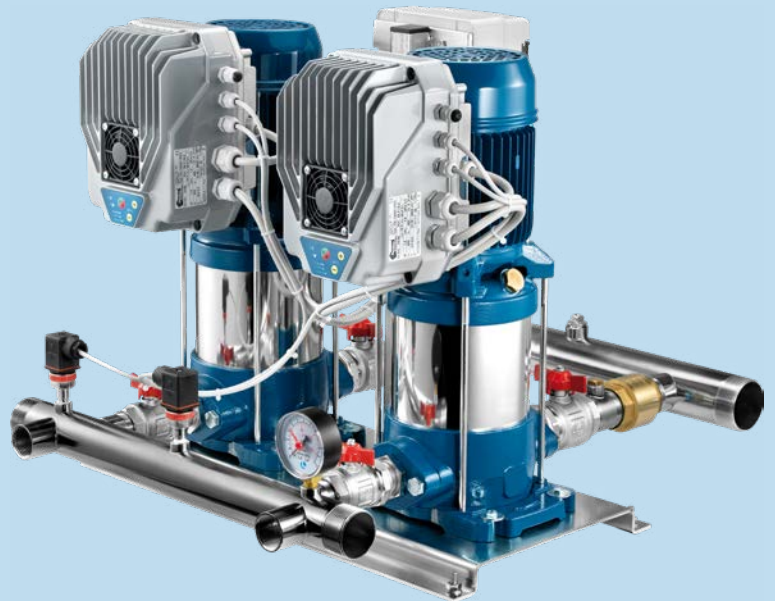

FIXED SPEED PUMPS

VARIABLE SPEED PUMPS



Pump specification

Flow up to 230 m³/h

Head up to 240 m

Start up direct, star/delta, inverter

Power supply voltage 1- 230V - 50Hz
3- 400V - 50Hz

Ambient temperature at nominal load max 40° C

Temperature of pumped liquid -5° C to +35° C (Horizontal pumps with Noryl impellers)
-5° C to +35° C (V-L-LG version)
-15° C to +90° C (SV version)
-15° C to +110° C (S-SL-SLX-SLG-SLXG version)
-15° C to +120° C (HS-HX version)

Name key

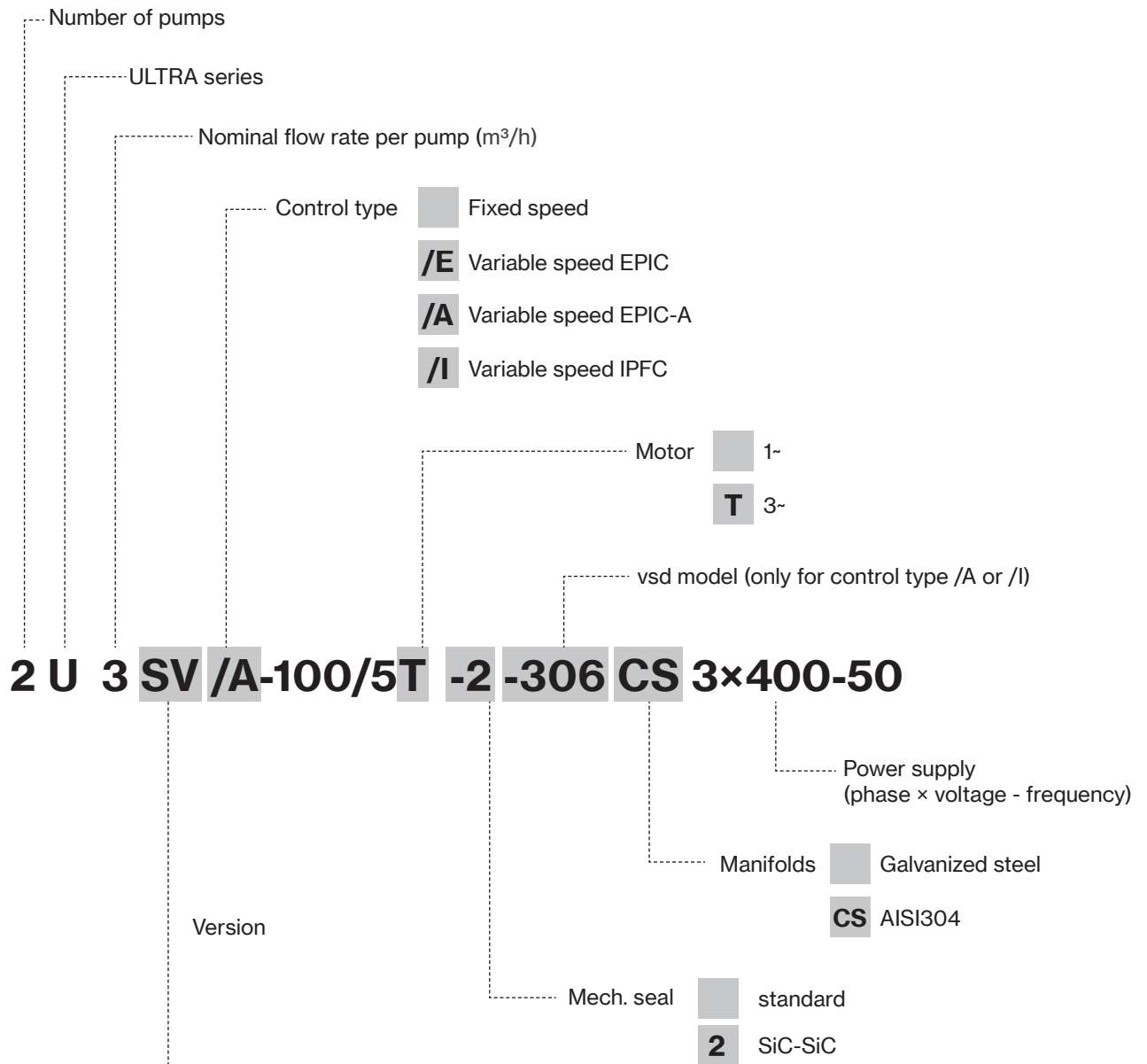

	PUMP TYPE	MAX LIQUID TEMPERATURE	IMPELLERS MATERIAL	PUMP SHELL AND BODY MATERIAL	PUMP AND MOTOR SHAFT	
S	Horizontal multistage	35° C	Noryl®	AISI 304	monoblock	
		110° C	AISI 304	AISI 304		
V	Vertical multistage, overlapped ports	35° C	Noryl®	AISI 304 / cast iron		
		90° C	AISI 304	AISI 304 / cast iron		
SV	Vertical multistage, inline ports	35° C	Noryl®	AISI 304 / cast iron		with coupling
		35° C	Noryl®	AISI 304 / cast iron		monoblock
		110° C	AISI 304	AISI 304 / cast iron		with coupling
		110° C	AISI 304	AISI 304		
		110° C	AISI 304	AISI 304 / cast iron		with coupling
		110° C	AISI 304	AISI 304		
		120° C	AISI 304	AISI 304 / cast iron		
		120° C	AISI 316	AISI 316		



Performance data and curves

2U

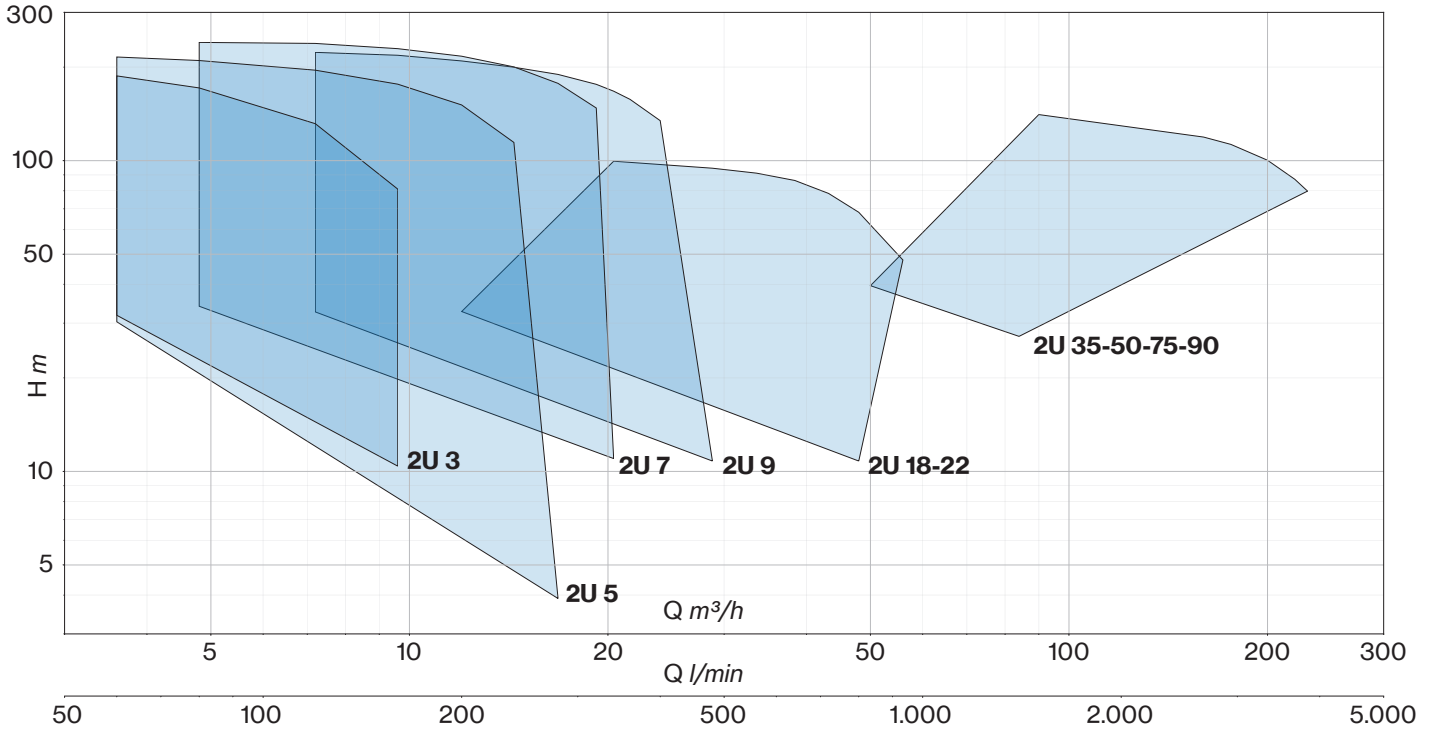

3U

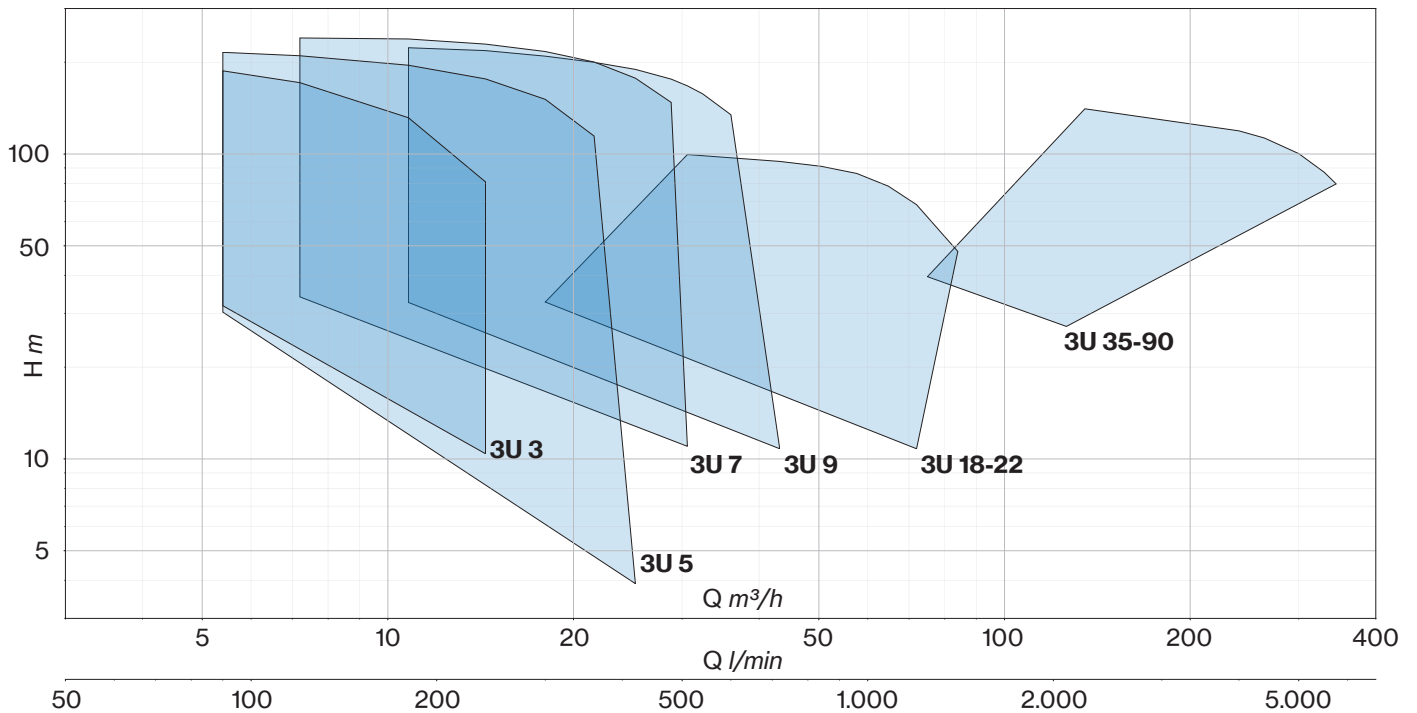

PERFORMANCE

TARGET (2 pumps)		VERSION			TYPE	P2 NOMINAL		Q (m³/h - l/min)																FIXED SPEED		VARIABLE SPEED	
		HORIZ.	VERT. OVERLAP	VERT. INLINE				0	12	14,4	16,8	19,2	20,4	21,6	24	28,8	33,6	38,4	43,2	48	56						
								0	200	240	280	320	340	360	400	480	560	640	720	800	933						
m³/h	bar	H (m)																1-	3-	/E	/I	/A	/I				
36	2	2U 18 2U 18S	2U 18V 2U 18SV	2U 18L 2U 18SL	250/3	2,5	1,85	34,7	32,9	32,6	32,2	31,6	31,3	31,0	30,1	28,0	24,7	20,6	15,9	10,7	-	■	-	■	■	■	
	2,5	-	-	2U 18H	300/3	3	2,2	41,2			37,1	36,3	35,9	35,5	34,4	32,3	28,9	24,8	19,4	13,5	-	■	-	■	■	■	
	3	2U 18 2U 18S	2U 18V 2U 18SV	2U 18L 2U 18SL	400/4	4	3	47,1	45,4	45,2	44,9	44,3	44,0	43,6	42,6	40,0	36,0	30,6	24,6	17,8	-	■	-	-	■	■	
	3,5	-	-	2U 18H	400/4	4	3	46,3	44,2	43,4	42,5	41,4	40,9	40,3	39,1	36,7	34,1	30,8	25,6	19,0	-	■	-	-	■	■	
	4	-	2U 18V 2U 18SV	2U 18L 2U 18SL	450/5	4,5	3,37	59,2	57,6	57,4	57,0	56,4	56,0	55,6	54,5	51,6	46,7	40,1	33,3	25,3	-	■	-	-	■	■	
	4,5	-	-	2U 18H	550/5	5,5	4	58,1	55,7	54,6	53,4	52,1	51,4	50,7	49,3	46,3	42,9	38,7	32,2	24,0	-	■	-	-	■	■	
	5	-	2U 18V 2U 18SV	2U 18L 2U 18SL	550/6	5,5	4	72,3			64,3	63,1	62,4	61,7	60,1	56,6	51,8	45,1	36,8	27,6	-	■	-	-	■	■	
	6	-	-	2U 18H	750/6	7,5	5,5	71,4	69,7	69,6	69,0	68,2	67,7	67,1	65,7	62,2	56,3	48,0	39,4	29,4	-	■	-	-	■	■	
	6,5	-	-	2U 18H	750/7	7,5	5,5	70,1	67,4	66,3	64,9	63,4	62,6	61,7	60,0	56,4	52,4	47,6	39,6	29,9	-	■	-	-	■	■	
	7	-	2U 18V 2U 18SV	2U 18L 2U 18SL	750/8	7,5	5,5	88,0			79,6	78,2	77,4	76,7	74,9	71,0	66,0	58,3	48,8	37,5	-	■	-	-	■	■	
	7,5	-	2U 18V 2U 18SV	2U 18L 2U 18SL	900/9	10	7,5	102,5			92,4	90,7	89,8	88,9	86,8	82,3	76,2	67,3	56,1	43,0	-	■	-	-	■	■	
	8	-	-	2U 18H	1000/8	10	7,5	96,1	94,2	94,1	93,5	92,4	91,7	90,9	89,1	84,5	77,0	66,1	54,2	41,1	-	■	-	-	■	■	
	9	-	-	2U 18H	1000/9	10	7,5	94,2	90,6	89,1	87,3	85,3	84,2	83,1	80,9	76,2	71,1	65,0	54,6	41,4	-	■	-	-	■	■	
	9,5	-	-	2U 18LG	920/10	10	7,5	108,5	106,9	107,0	106,4	105,3	104,5	103,7	101,7	96,8	88,6	75,9	62,6	47,8	-	■	-	-	■	■	
10	-	-	2U 18LG	1000/11	10	7,5	106,4	102,8	101,3	99,3	97,2	96,1	94,9	92,4	87,3	81,6	75,0	63,5	48,5	-	■	-	-	■	■		
44	3	-	-	2U 22H	400/3	4	3	45,0					40,8	40,5	39,9	38,3	36,6	34,2	30,5	25,8	16,6	-	■	-	■	■	■
	4	-	-	2U 22H	550/4	5,5	4	62,2					55,5	55,1	54,2	52,4	50,2	47,3	42,7	36,8	25,2	-	■	-	-	■	■
	5	-	-	2U 22H	750/5	7,5	5,5	78,6					70,6	70,1	69,0	67,0	64,2	60,8	55,3	47,9	33,5	-	■	-	-	■	■
	6,5	-	-	2U 22H	1000/6	10	7,5	94,2					86,0	85,3	84,1	81,7	79,2	76,8	63,6	52,8	42,0	-	■	-	-	■	■
	7,5	-	-	2U 22H	1000/7	10	7,5	109,5					99,6	98,8	97,4	94,6	91,2	86,3	78,4	68,2	47,9	-	■	-	-	■	■

TARGET (2 pumps)		VERSION			TYPE	P2 NOMINAL		Q (m³/h - l/min)																FIXED SPEED		VARIABLE SPEED					
		HORIZ.	VERT. OVERLAP	VERT. INLINE				0	50	60	68	84	90	100	120	128	140	160	176	200	230										
								0	833	1000	1133	1400	1500	1667	2000	2133	2333	2667	2933	3333	3833										
m³/h	bar	H (m)																1-	3-	/E	/I	/A	/I								
70	3	-	-	2U 35H	750/2	7,5	5,5	48,5	39,6	36,9	34,4	27,2													-	■	-	-	■	■	
	4,5	-	-	2U 35H	1000/3	10	7,5	72,2	58,2	54,2	50,3	39,5													-	■	-	-	■	■	
	5	-	-	2U 35H	1000/4-2R	10	7,5	85,1	68,6	63,9	58,4	44,7													-	■	-	-	■	■	
	6	-	-	2U 35H	1500/4-1R	15	11	92,8	75,3	70,2	65,2	50,8														-	■	-	-	■	■
	7	-	-	2U 35H	1500/4	15	11	99,4	81,0	76,3	71,8	58,5														-	■	-	-	■	■
	8,5	-	-	2U 35H	2000/5	20	15	121,1	99,3	93,1	87,4	70,0														-	■	-	-	■	■
	10	-	-	2U 35H	2000/6	20	15	145,6	119,3	111,9	105,0	84,2														-	■	-	-	■	■
100	11	-	-	2U 35H	2000/7-1R	20	15	163,3	132,3	123,2	114,0	89,1													-	■	-	-	■	■	
	3	-	-	2U 50H	1000/2	10	7,5	49,0			42,0	38,8	37,2	34,3	27,5	24,1									-	■	-	-	■	■	
	5	-	-	2U 50H	1500/3	15	11	74,2			65,0	60,9	58,8	54,8	45,5	41,0									-	■	-	-	■	■	
	7	-	-	2U 50H	2000/4	20	15	97,5			86,4	81,3	78,5	73,2	60,8	54,7									-	■	-	-	■	■	
150	9	-	-	2U 50H	2500/5	25	18,5	122,3			109,1	102,9	99,5	92,9	77,5	70,0									-	■	-	-	■	-	
	11	-	-	2U 50H	3000/6	30	22	146,0			129,8	122,2	118,0	110,0	91,6	82,5									-	■	-	-	■	-	
	3,5	-	-	2U 75H	1500/2	15	11	59,3			51,2	49,9	47,5	46,8	45,5	43,2	42,0	39,9	35,3	30,8					-	■	-	-	■	■	
	6	-	-	2U 75H	2500/3	25	18,5	89,6			77,6	75,6	72,0	70,9	69,0	65,7	63,9	60,7	53,9	47,2					-	■	-	-	■	-	
	8	-	-	2U 75H	3000/4	30	22	111,8			100,8	99,2	95,8	94,5	92,4	88,4	86,3	82,3	73,3	62,9					-	■	-	-	■	-	
180	10	-	-	2U 75H	4000/5	40	30	142,4			129,2	127,1	123,0	121,5	119,0	114,1	111,5	106,9	96,3	84,6					-	■	-	-	■	-	
	11	-	-	2U 75H	4000/6-2R	40	30	153,5			141,6	139,5	135,1	133,3	130,3	123,4	119,6	112,9	99,0	84,1					-	■	-	-	■	-	
	2,5	-	-	2U 90H	1500/2-2R	15	11	49,6						42,4	41,3	39,0	38,1	36,6	33,2	29,4	22,7	11,7		-	■	-	-	■	■		
	4	-	-	2U 90H	2000/2	20	15	69,2						56,6	54,5	50,5	49,2	47,3	44,3	41,6	36,3	27,3		-	■	-	-	■	■		
	6,5	-	-	2U 90H	3000/3	30	22	92,4						82,6	80,6	76,7	75,3	73,2	69,4	65,5	57,8	45,2		-	■	-	-	■	-		
180	9	-	-	2U 90H	4000/4	40	30	125,6						113,0	110,4	105,2	103,3	100,6	95,7	90,7	80,8	64,4		-	■	-	-	■	-		
	11	-	-	2U 90H	5000/5	50	37	156,6						140,7	137,4	130,9	128,6	125,2	119,1	112,8	100,3	79,8		-	■	-	-	■	-		



CURVES 2U

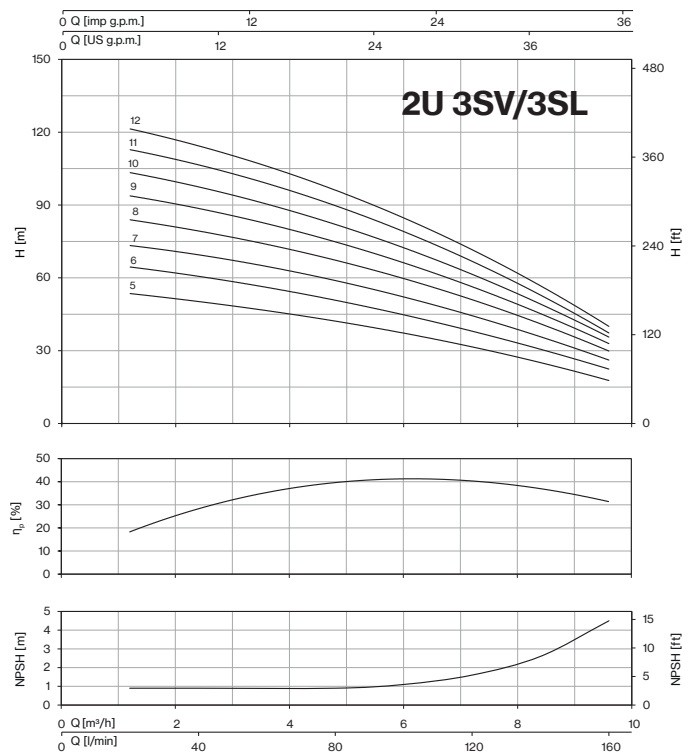
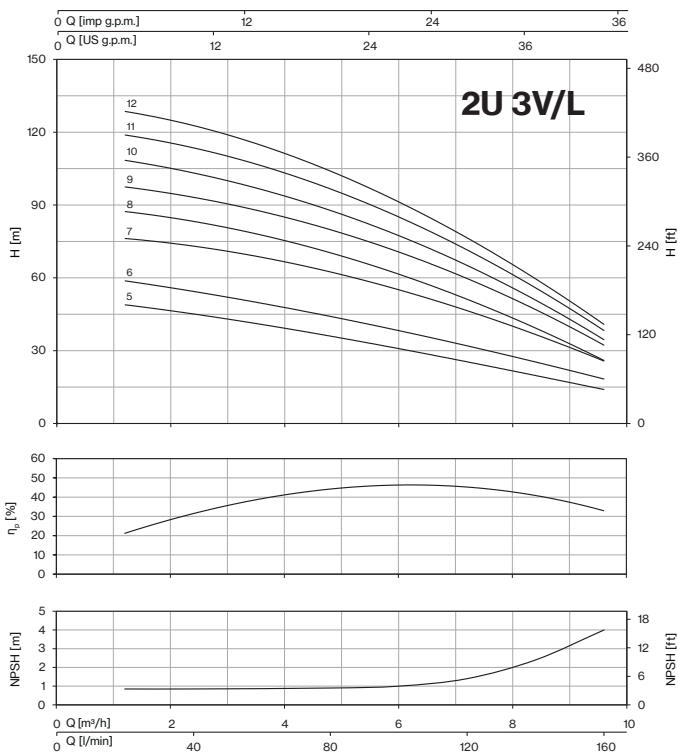
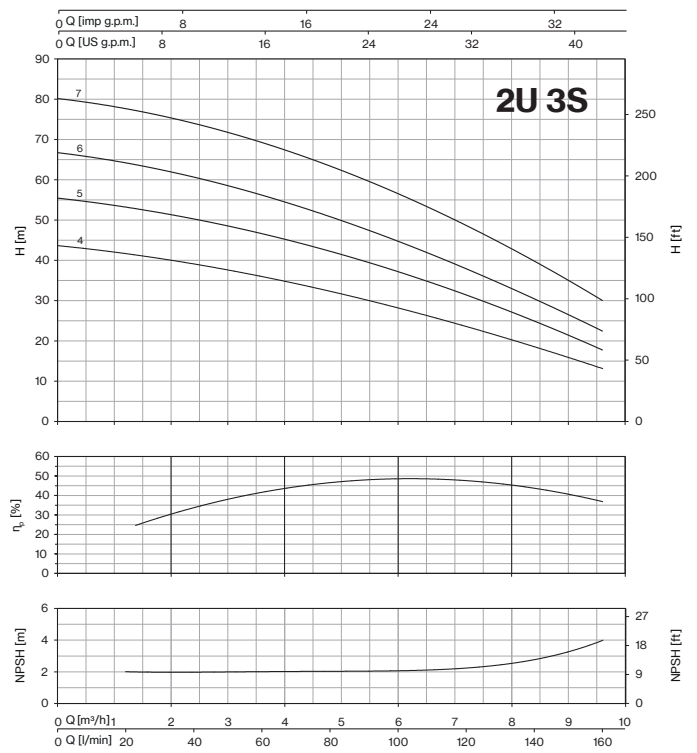
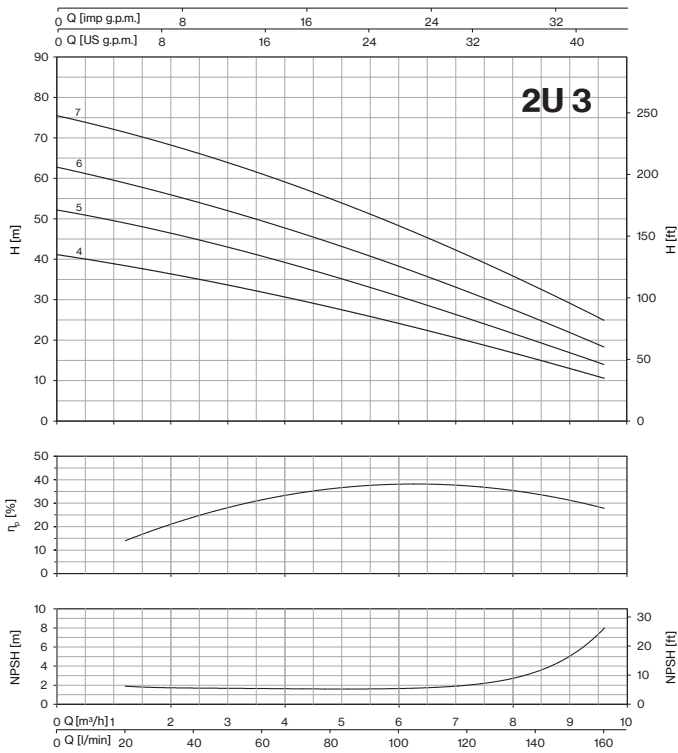

CURVES 2U

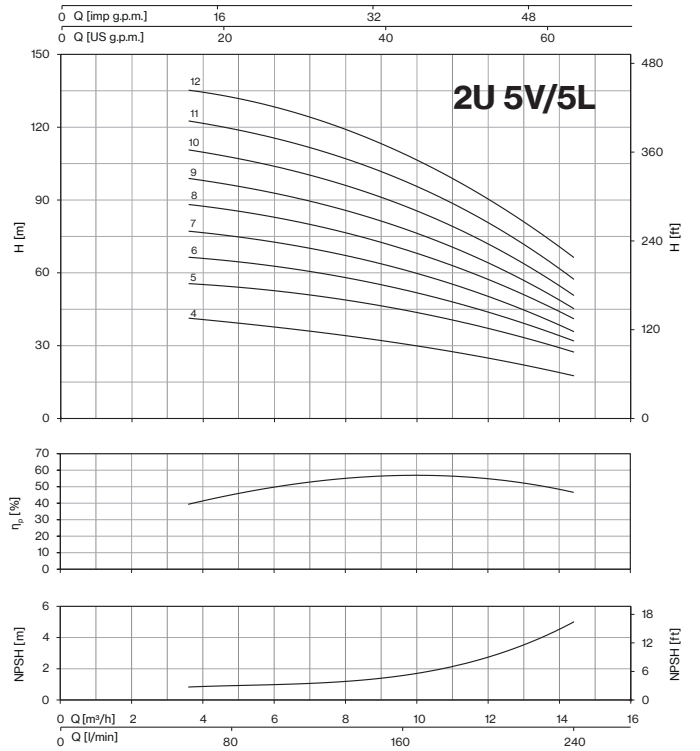
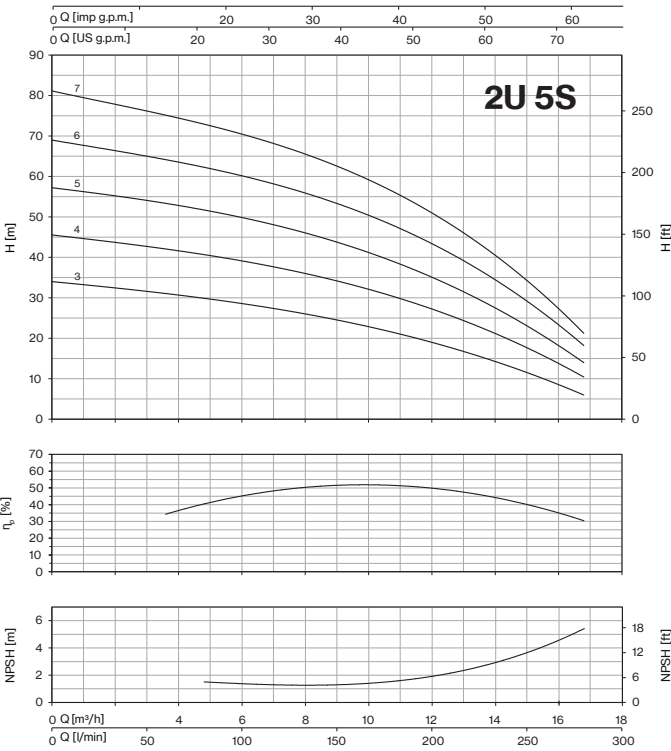
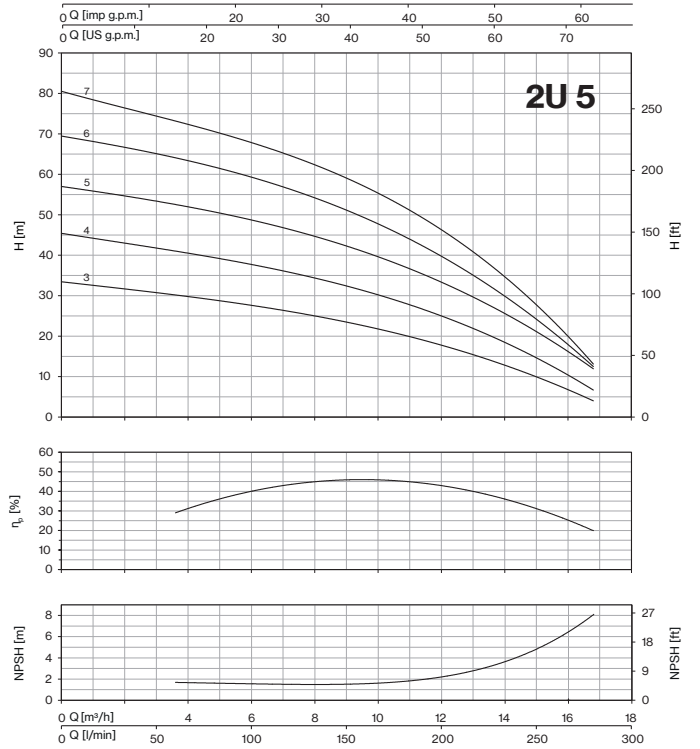
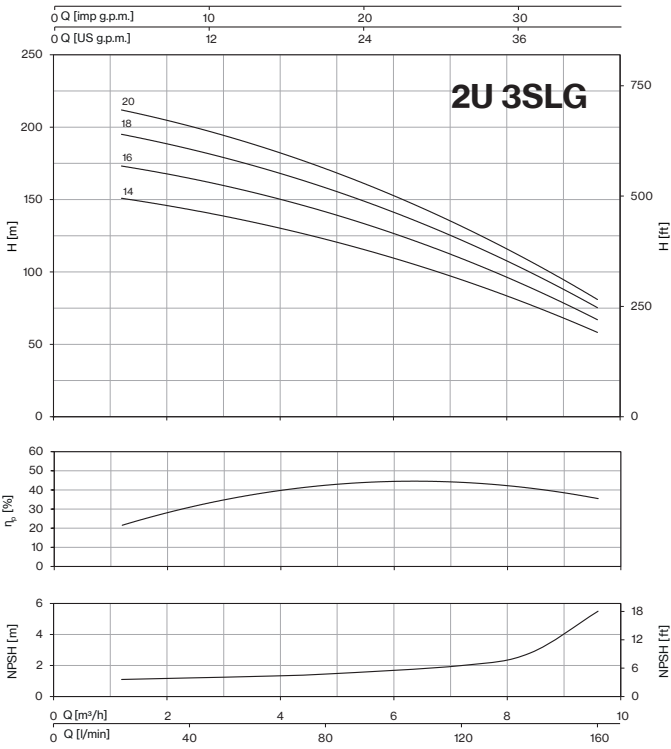

CURVES 2U

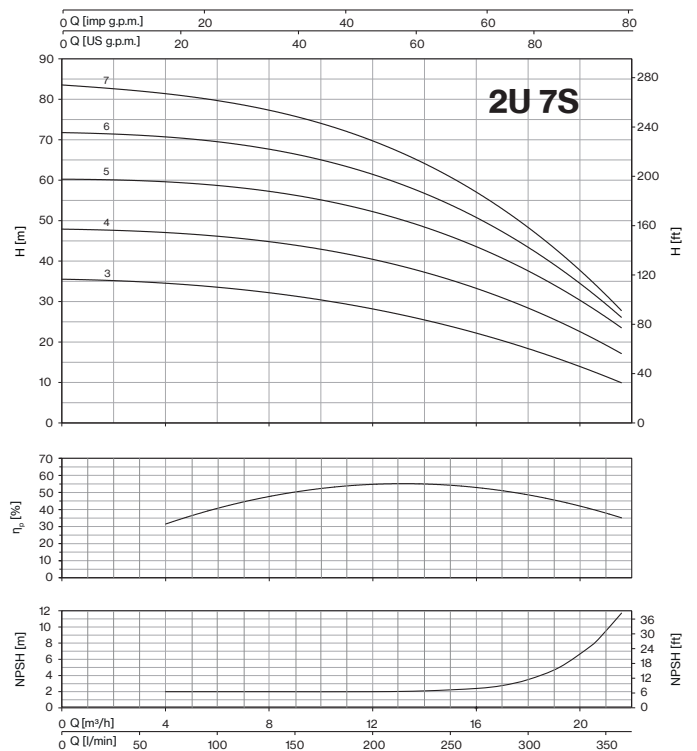
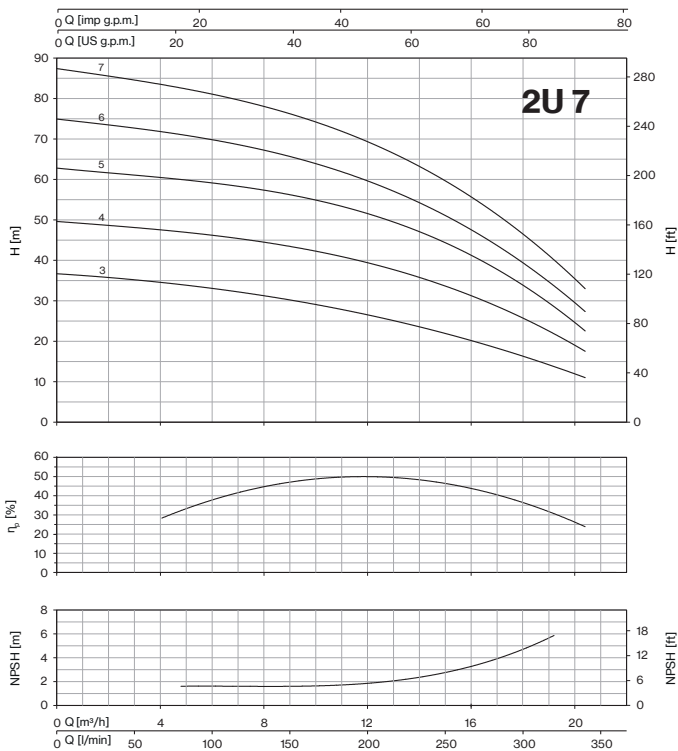
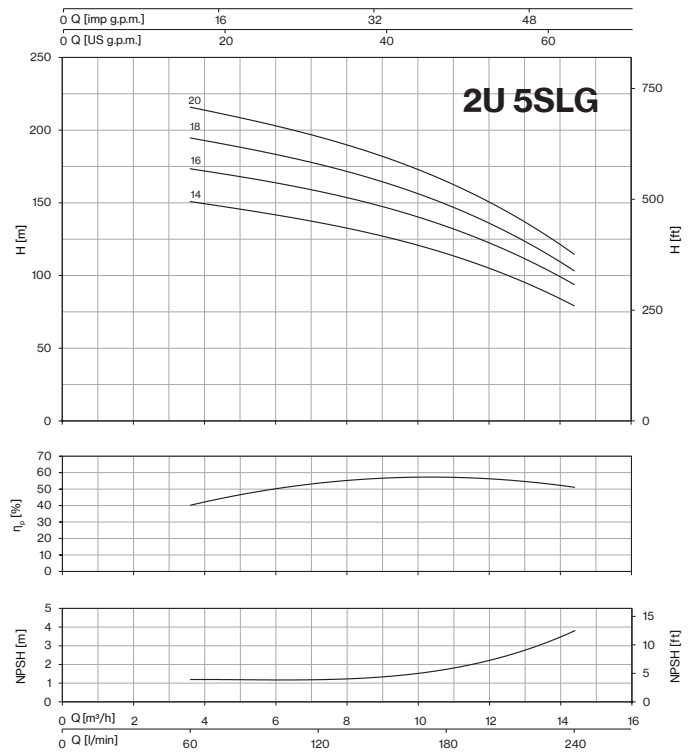
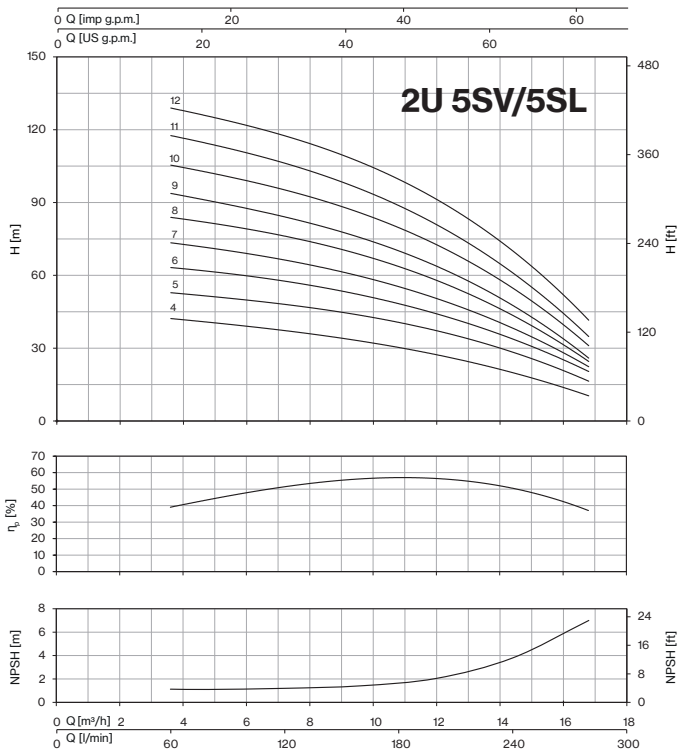

CURVES 2U

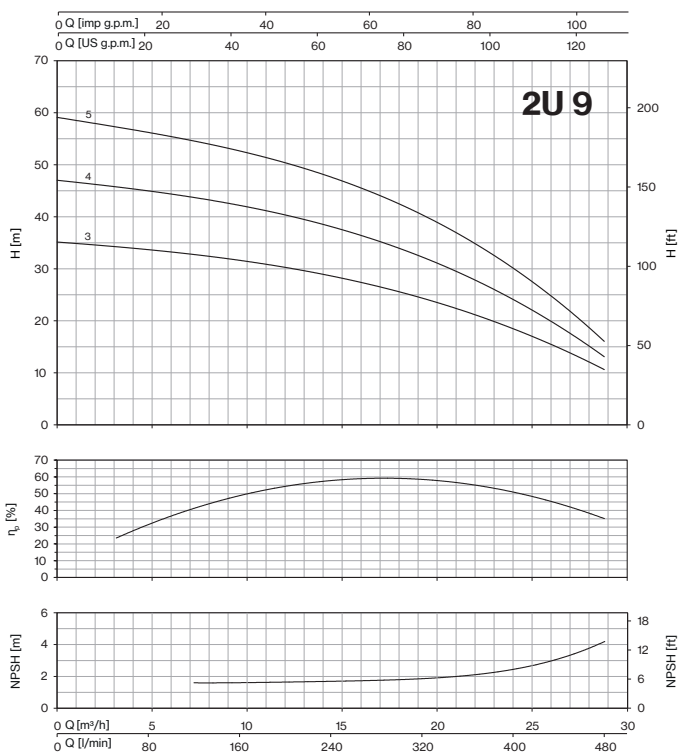
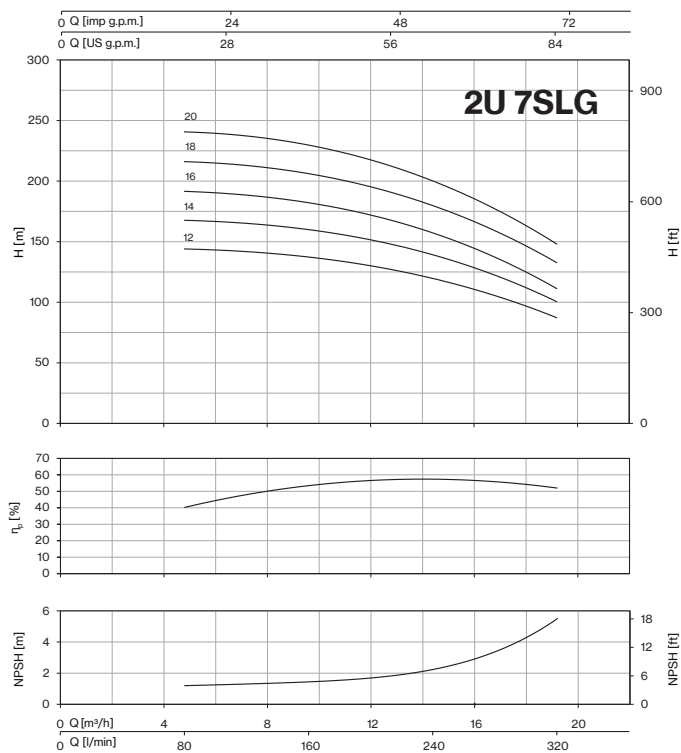
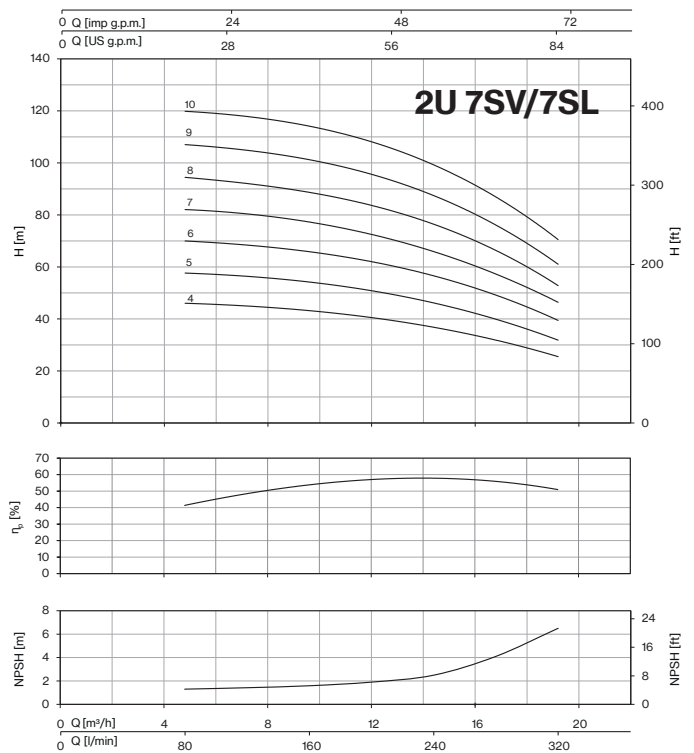
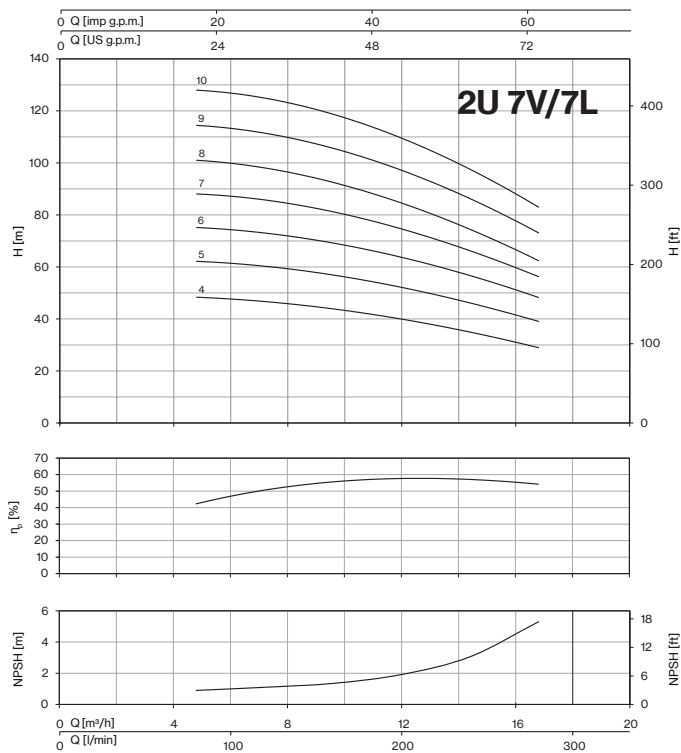

CURVES 2U

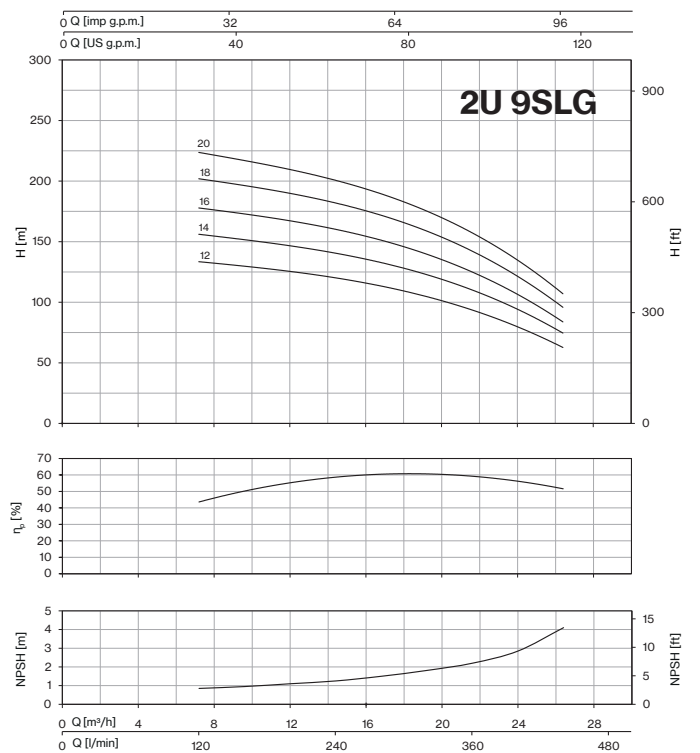
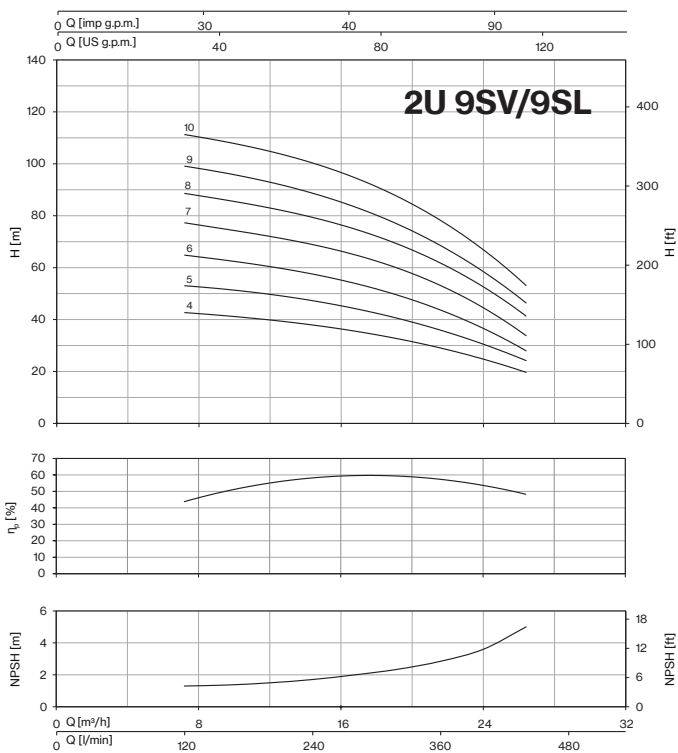
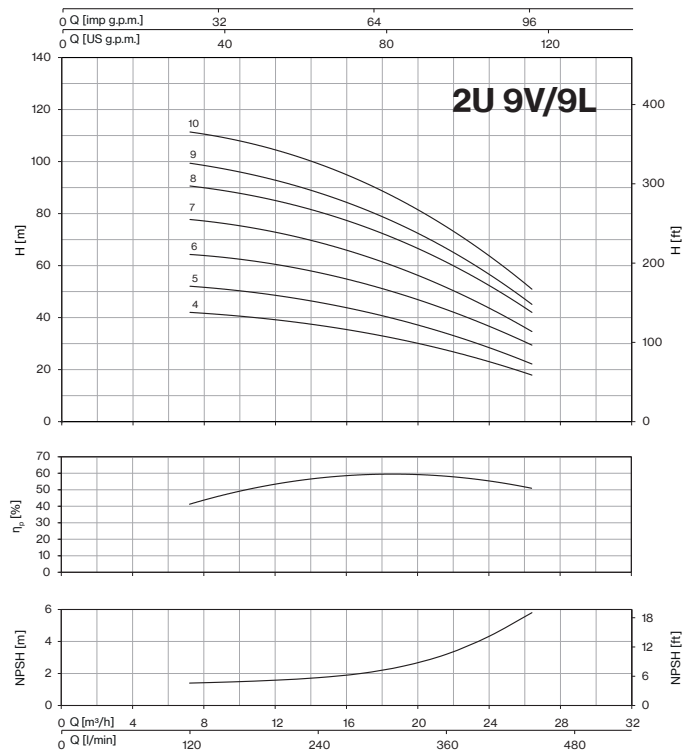
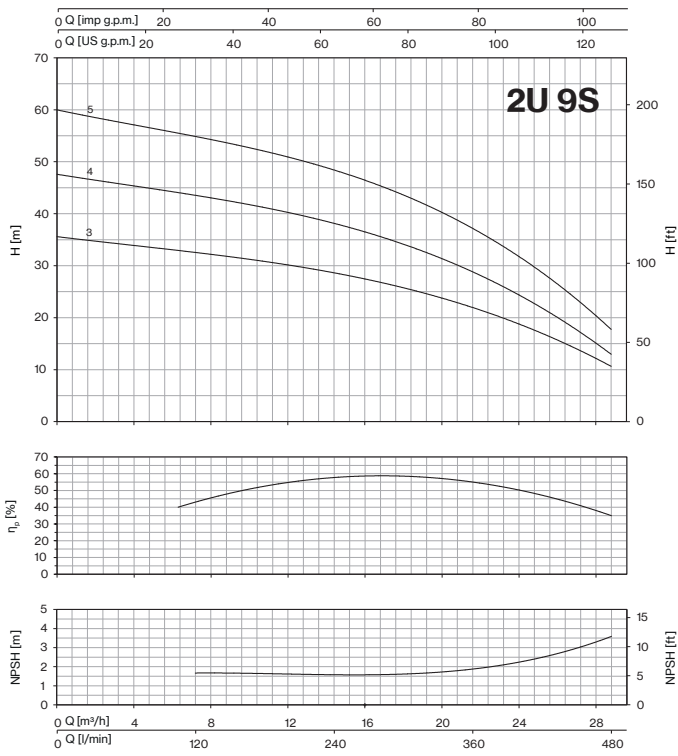

CURVES 2U

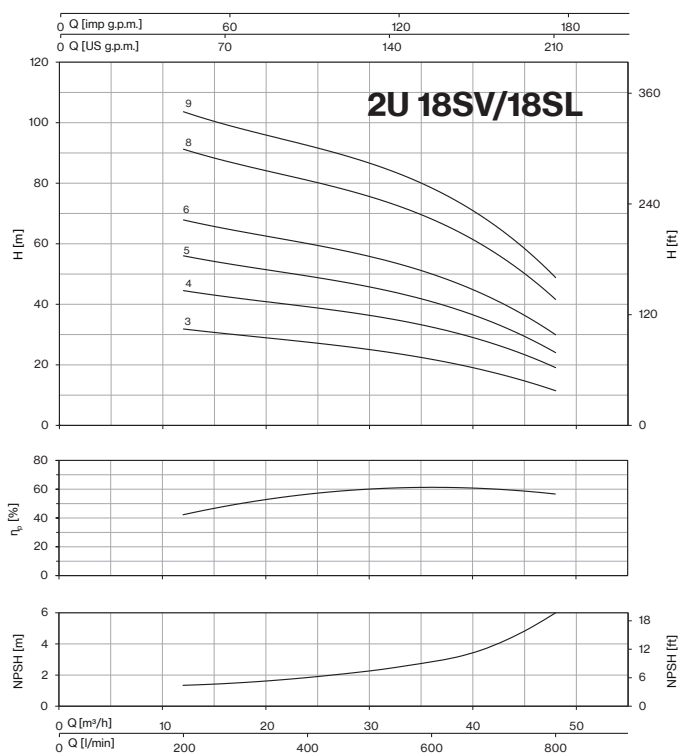
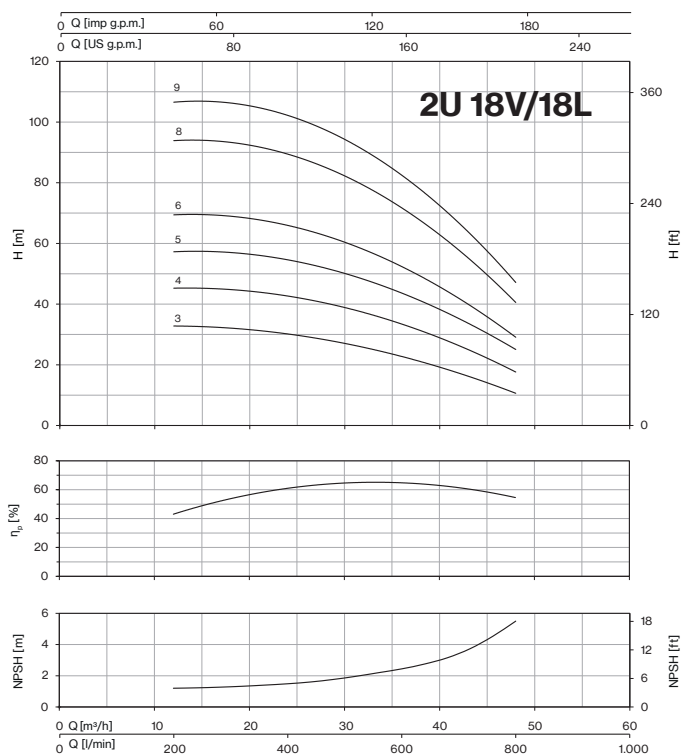
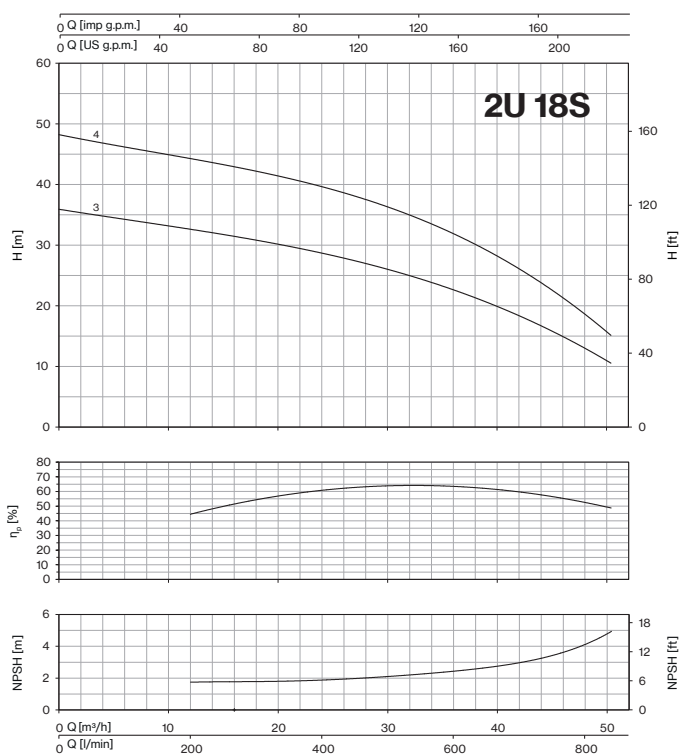
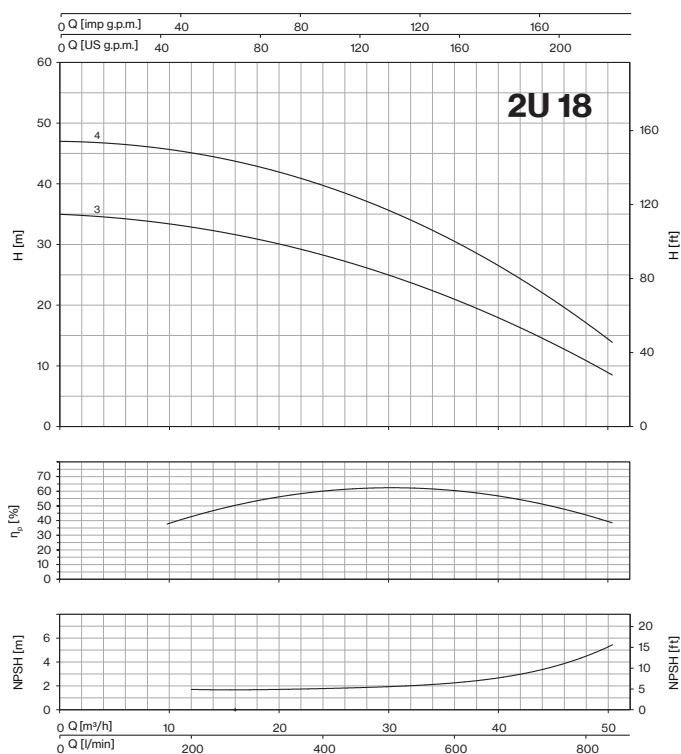

CURVES 2U

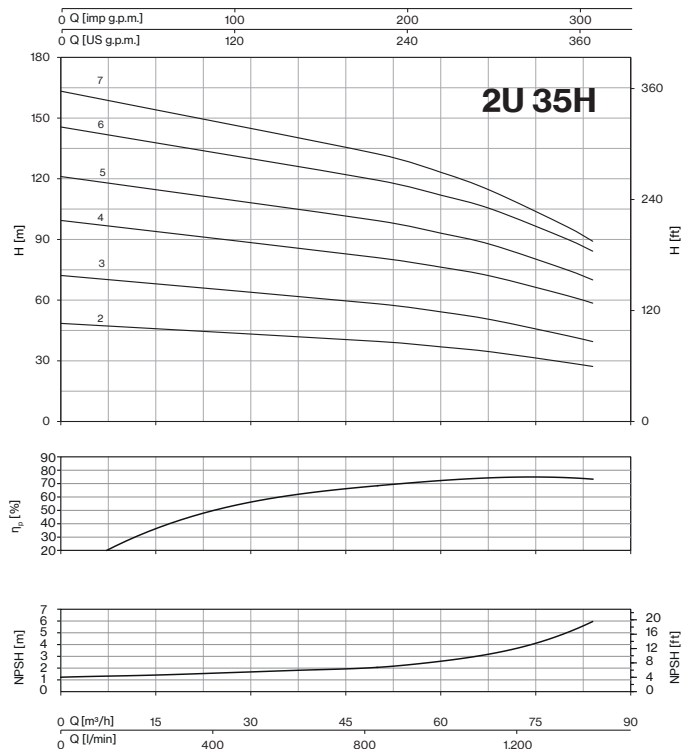
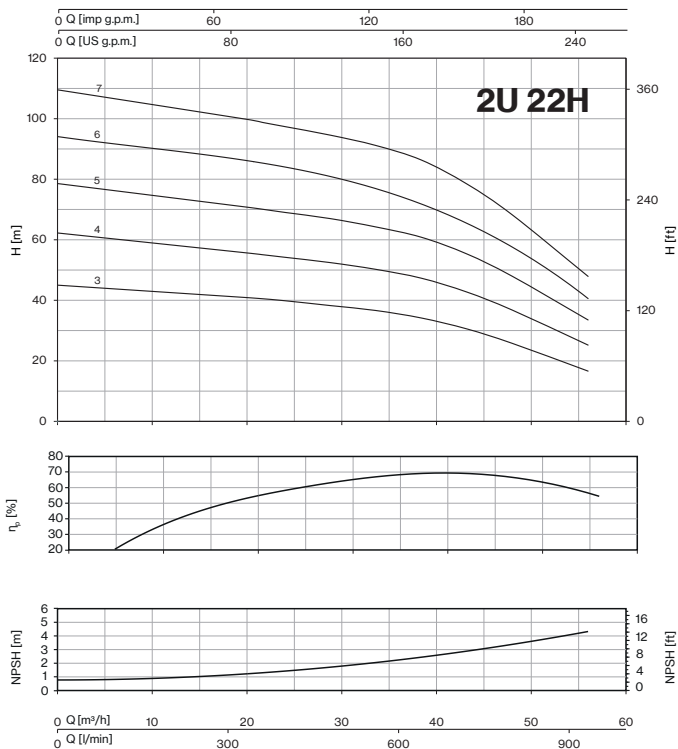
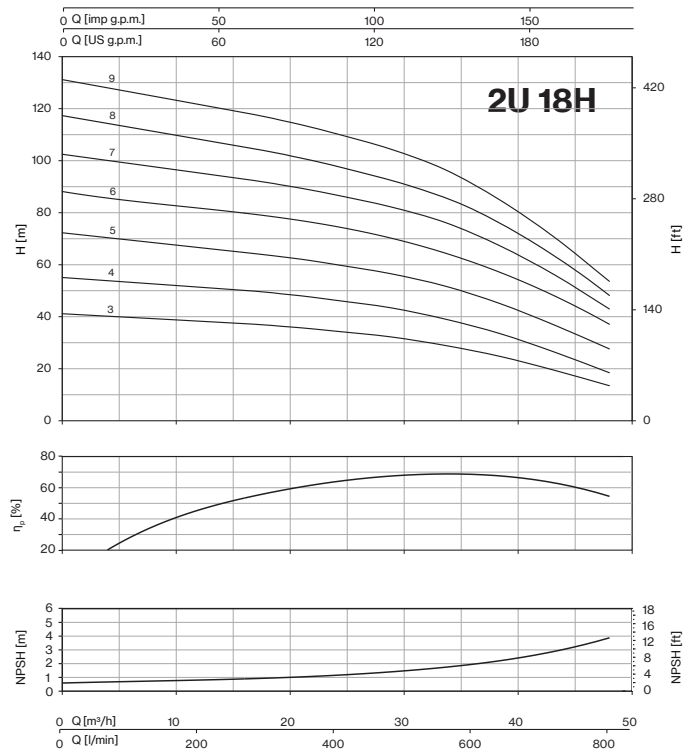
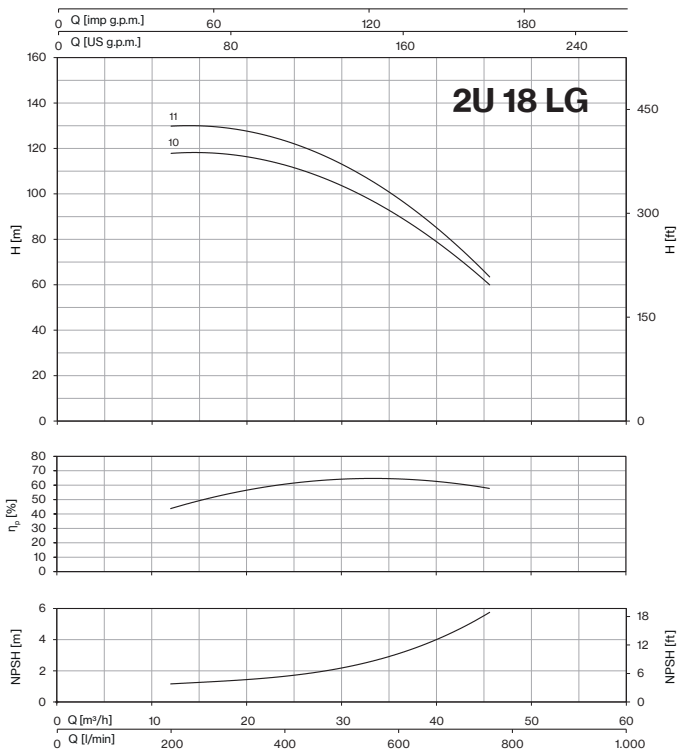

CURVES 2U

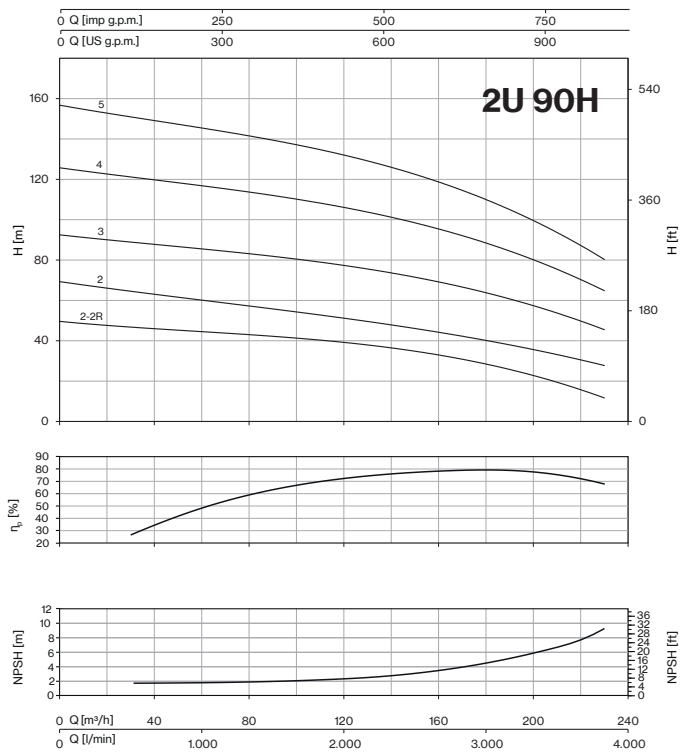
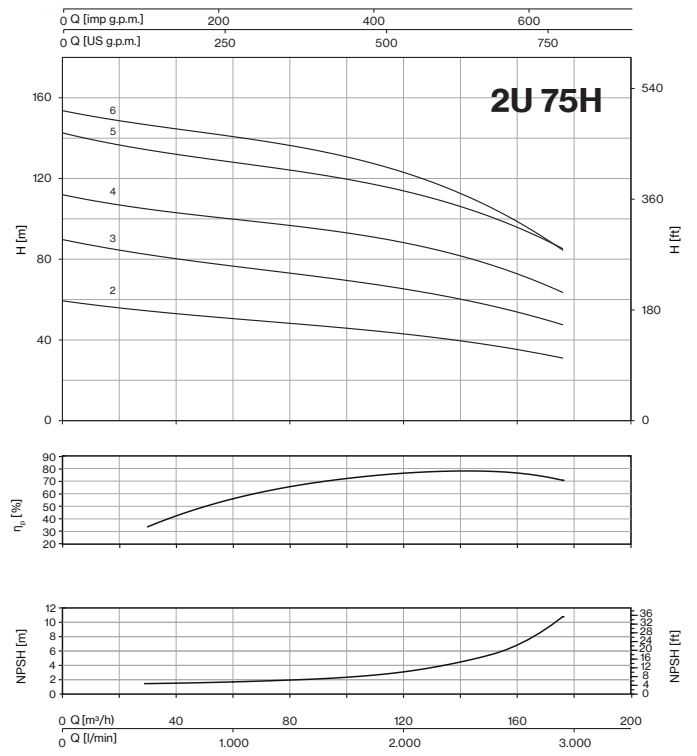
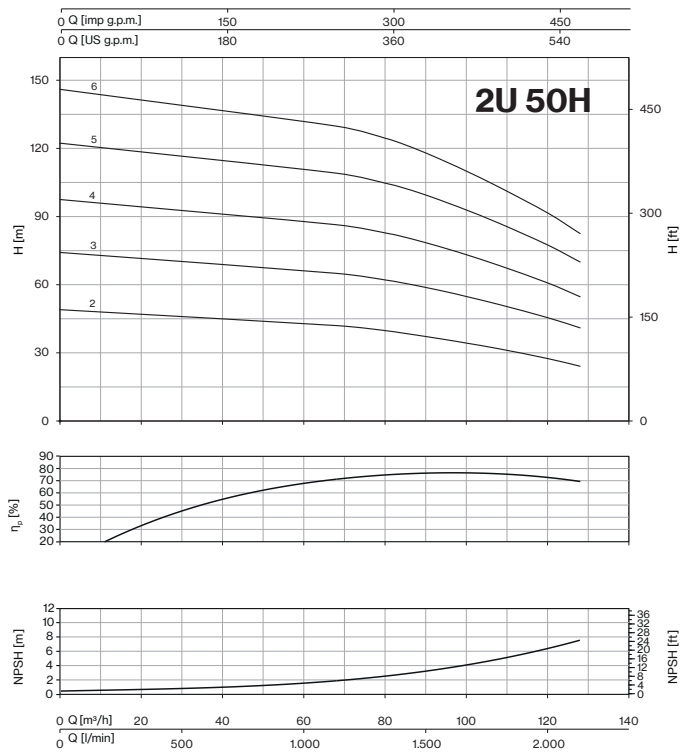

2U V

Variable speed EPIC and EPIC-A

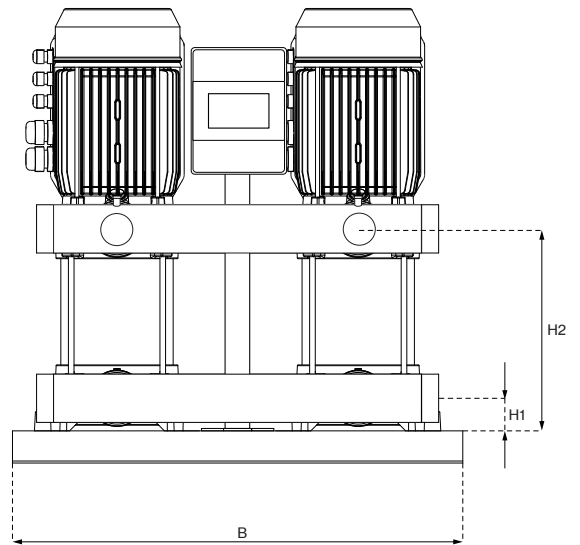
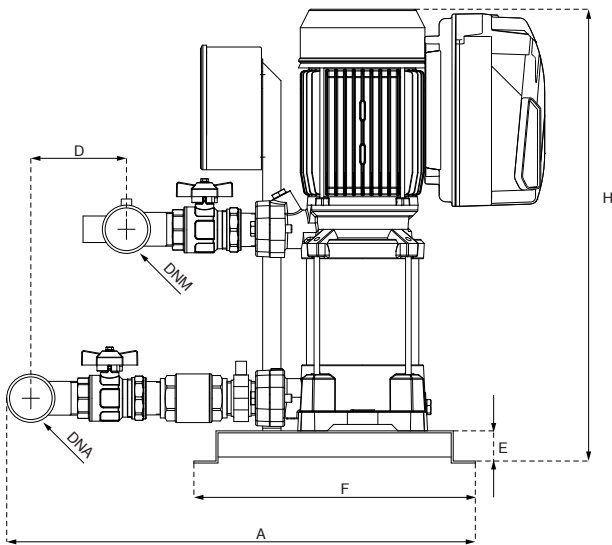

EPIC-A mounted on a skid rod for power ratings above 4 HP

VERTICAL MODEL V		P1	In		Required tank	DIMENSIONS												Kg		
EPIC	EPIC-A		3- 230V	3- 400V		A	B	D	E	F	H	H1	H2	DNA	DNM					
1- 230V-in 3- 230V-out	3- 400V-in 3- 400V-out															kW (x2)	A (x2)		Lt	mm
2U 3V/E-100/5T	2U 3V/A-100/5T-304	1,01	3,3	1,9	2x 8	633	560	100	40	350	453	40	178	2" G	1" 1/2 G	61				
2U 3SV/E-100/5T	2U 3SV/A-100/5T-304	0,92	2,9	1,7	2x 8	633	560	100	40	350	477	40	202			63				
2U 3V/E-120/6T	2U 3V/A-120/6T-304	1,23	4,5	2,6	2x 8	633	560	100	40	350	561	40	226			76				
2U 3SV/E-120/6T	2U 3SV/A-120/6T-304	1,11	4,3	2,5	2x 8	633	560	100	40	350	585	40	250			76				
2U 3V/E-150/7T	2U 3V/A-150/7T-304	1,2	5,2	3	2x 8	633	560	100	40	350	609	40	274			78				
2U 3SV/E-150/7T	2U 3SV/A-150/7T-304	1,4	5,4	3,1	2x 8	633	560	100	40	350	633	40	298			81				
2U 3V/E-180/8T	2U 3V/A-180/8T-304	1,4	5,4	3,1	2x 8	633	560	100	40	350	657	40	322			82				
2U 3SV/E-180/8T	2U 3SV/A-180/8T-304	1,5	5,5	3,2	2x 8	633	560	100	40	350	681	40	346			82				
2U 3V/E-200/9T	2U 3V/A-200/9T-304	1,5	5,5	3,2	2x 8	633	560	100	40	350	609	40	274			2" G	1" 1/2 G	78		
2U 3SV/E-200/9T	2U 3SV/A-200/9T-304	1,6	5,7	3,3	2x 8	633	560	100	40	350	633	40	298					81		
2U 3V/E-250/10T	2U 3V/A-250/10T-306	1,7	6,1	3,5	2x 8	633	560	100	40	350	657	40	322					82		
2U 3SV/E-250/10T	2U 3SV/A-250/10T-306	1,7	6,1	3,5	2x 8	633	560	100	40	350	681	40	346					82		
2U 3V/E-280/11T	2U 3V/A-280/11T-306	1,8	6,6	3,8	2x 8	633	560	100	40	350	609	40	274					2" G	1" 1/2 G	76
2U 3SV/E-280/11T	2U 3SV/A-280/11T-306	1,9	6,8	3,9	2x 8	633	560	100	40	350	537	40	226							76
-	2U 3V/A-300/12T-306	2	-	4	2x 8	633	560	100	40	350	561	40	250	76						
-	2U 3SV/A-300/12T-306	2,1	-	4,1	2x 8	633	560	100	40	350	585	40	274	76						
2U 5V/E-120/4T	2U 5V/A-120/4T-304	1,13	4,3	2,5	2x 20	633	560	100	40	350	429	40	178	2" G	1" 1/2 G					64
2U 5SV/E-120/4T	2U 5SV/A-120/4T-304	1,08	4,2	2,4	2x 20	633	560	100	40	350	513	40	202							75
2U 5V/E-150/5T	2U 5V/A-150/5T-304	1,4	5,4	3,1	2x 20	633	560	100	40	350	537	40	226			76				
2U 5SV/E-150/5T	2U 5SV/A-150/5T-304	1,3	5,4	3,1	2x 20	633	560	100	40	350	561	40	250			76				
2U 5V/E-180/6T	2U 5V/A-180/6T-304	1,6	5,7	3,3	2x 20	633	560	100	40	350	585	40	274			76				
2U 5SV/E-180/6T	2U 5SV/A-180/6T-304	1,6	5,7	3,3	2x 20	633	560	100	40	350	609	40	274			76				
2U 5V/E-200/7T	2U 5V/A-200/7T-304	1,8	6,2	3,6	2x 20	633	560	100	40	350	633	40	298			77				
2U 5SV/E-200/7T	2U 5SV/A-200/7T-304	1,8	6,2	3,6	2x 20	633	560	100	40	350	657	40	322			79				
2U 5V/E-250/8T	2U 5V/A-250/8T-306	2,1	7,1	4,1	2x 20	633	560	100	40	350	681	40	346			80				
2U 5SV/E-250/8T	2U 5SV/A-250/8T-306	2,1	7,1	4,1	2x 20	633	560	100	40	350	712	40	346			80				
-	2U 5V/A-280/9T-306	2,3	-	4,3	2x 20	633	560	100	40	350	736	40	370	2" G	1" 1/2 G	93				
-	2U 5SV/A-280/9T-306	2,3	-	4,3	2x 20	633	560	100	40	350	736	40	370			93				
-	2U 5V/A-300/10T-306	2,6	-	4,9	2x 20	633	560	100	40	350	736	40	370			93				
-	2U 5SV/A-300/10T-306	2,6	-	4,9	2x 20	633	560	100	40	350	736	40	370	93						
-	2U 5V/A-350/11T-306	2,9	-	5,3	2x 20	633	560	100	40	350	736	40	370	93						
-	2U 5SV/A-350/11T-306	2,9	-	5,3	2x 20	633	560	100	40	350	736	40	370	93						
-	2U 5V/A-380/12T-309	3,2	-	6	2x 20	633	560	100	40	350	736	40	370	93						
-	2U 5SV/A-380/12T-309	3,2	-	6	2x 20	633	560	100	40	350	736	40	370	93						

Dimensions and weights may differ slightly and therefore should be considered as indicative



2U V

Variable speed EPIC and EPIC-A

VERTICAL MODEL V		P1	In		Required tank	DIMENSIONS										Kg
EPIC	EPIC-A		3- 230V	3- 400V		A	B	D	E	F	H	H1	H2	DNA	DNM	
1- 230V-in 3- 230V-out	3- 400V-in 3- 400V-out	kW (x2)	A (x2)		Lt	mm										
2U 7V/E-180/4T	2U 7V/A-180/4T-304	1,6	5,7	3,3	2x 20	673	560	152	40	350	462	40	178			82
2U 7SV/E-180/4T	2U 7SV/A-180/4T-304	1,7	6,1	3,5												
2U 7V/E-250/5T	2U 7V/A-250/5T-306	2	6,9	4	2x 20	673	560	152	40	350	513	40	202			81
2U 7SV/E-250/5T	2U 7SV/A-250/5T-306	2,1	6,9	4												
-	2U 7V/A-300/6T-306	2,4	-	4,7	2x 20	673	560	152	40	350	537	40	226			84
-	2U 7SV/A-300/6T-306	2,5	-	4,8												
-	2U 7V/A-350/7T-306	2,8	-	5,1	2x 20	673	560	152	40	350	615	40	250	2" ½ G	2" G	94
-	2U 7SV/A-350/7T-306	2,9	-	5,3												
-	2U 7V/A-400/8T-309	3,1	-	5,9	2x 20	673	560	152	40	350	640	40	274			97
-	2U 7SV/A-400/8T-309	3,3	-	6,1												
-	2U 7V/A-450/9T-309	3,6	-	6,5	2x 20	673	560	152	40	350	693	40	301			106
-	2U 7SV/A-450/9T-309	3,7	-	6,7												
-	2U 7V/A-550/10T-309	4	-	7,7	2x 20	673	560	152	40	350	716	40	325			123
-	2U 7SV/A-550/10T-309	4,1	-	7,9												
2U 9V/E-200/4T	2U 9V/A-200/4T-304	1,7	6,1	3,5	2x 20	673	560	152	40	350	513	40	202			80
2U 9SV/E-200/4T	2U 9SV/A-200/4T-304	1,8	6,2	3,6												
-	2U 9V/A-250/5T-306	2,1	-	4,1	2x 20	673	560	152	40	350	543	40	232			79
-	2U 9SV/A-250/5T-306	2,2	-	4,2												
-	2U 9V/A-300/6T-306	2,6	-	5	2x 20	673	560	152	40	350	573	40	262			81
-	2U 9SV/A-300/6T-306	2,6	-	5												
-	2U 9V/A-400/7T-309	3	-	5,8	2x 20	673	560	152	40	350	657	40	292	2" ½ G	2" G	97
-	2U 9SV/A-400/7T-309	3,1	-	5,9												
-	2U 9V/A-450/8T-309	3,5	-	6,4	2x 20	673	560	152	40	350	717	40	325			105
-	2U 9SV/A-450/8T-309	3,6	-	6,5												
-	2U 9V/A-500/9T-309	3,9	-	6,9	2x 20	673	560	152	40	350	747	40	355			108
-	2U 9SV/A-500/9T-309	4	-	7												
-	2U 9V/A-550/10T-309	4,3	-	8,1	2x 20	673	560	152	40	350	777	40	385			132
-	2U 9SV/A-550/10T-314	4,4	-	8,2												
-	2U 18V/A-250/3T-306	2,2	-	4,2	1x 80	720	620	133	40	350	521	50	211			90
-	2U 18SV/A-250/3T-306	2,3	-	4,3												
-	2U 18V/A-400/4T-309	3	-	5,8	1x 80	720	620	133	40	350	613	50	248			104
-	2U 18SV/A-400/4T-309	3,1	-	5,9												
-	2U 18V/A-450/5T-309	3,9	-	6,9	1x 80	720	620	133	40	350	680	50	289	3" G	2" ½ G	115
-	2U 18SV/A-450/5T-309	3,9	-	6,9												
-	2U 18V/A-550/6T-314	4,6	-	8,4	1x 80	720	620	133	40	350	718	50	326			140
-	2U 18SV/A-550/6T-314	4,7	-	8,5												
-	2U 18V/A-750/8T-314	6,2	-	11,2	1x 80	720	620	133	40	350	855	50	401			155
-	2U 18SV/A-750/8T-314	6,2	-	11,2												
-	2U 18V/A-900/9T-318	6,9	-	12,8	1x 80	720	620	133	40	350	892	50	439			166
-	2U 18SV/A-900/9T-318	7	-	12,9												

