

CA-CAX

~ 3500 rpm

4CA-4CAX

~ 1750 rpm



CA-4CA



CAX-4CAX



Centrifugal Flanged EN 733

Bare shaft centrifugal pumps constructed in compliance with EN 733 standards; widely used in water supplies, pressurisation and fire-fighting systems.

Construction features

Pump body	cast iron (CA); stainless steel AISI 316 (CAX)
Motor bracket	cast iron
Impeller	cast iron, bronze, steel (CA); stainless steel AISI 316 (CAX)
Seal type	mechanical (CA-CAX) or gland packing graphite impregnated (CAT-CATX)
Pump shaft end	stainless steel AISI 316
Liquid temperature	-10 ÷ +90 °C
Operating pressure	max 10 bar max 14 bar (... -315 ~ 3500 rpm)

Motor

Available with IE3-IE4 efficiency class motor

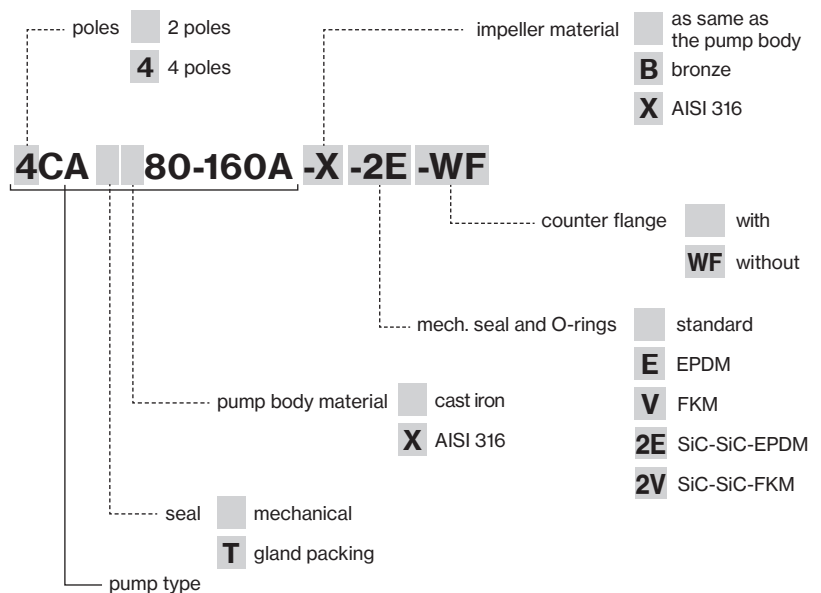

CA-CAX

~ 3500 rpm

Centrifugal Flanged
EN 733

4CA-4CAX

~ 1750 rpm

Construction versions

The pumps can be fitted next to a motor on a common baseplate, with the pump shaft and the motor shaft connected by a flexible coupling.

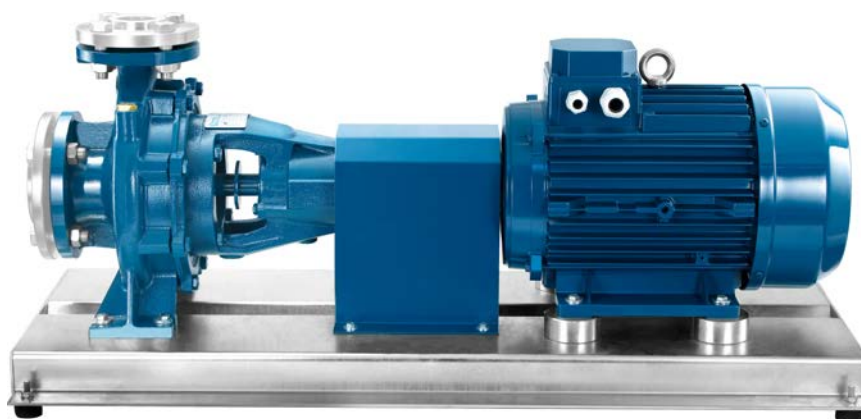

CA-4CA with motor
counterflanges supplied separately

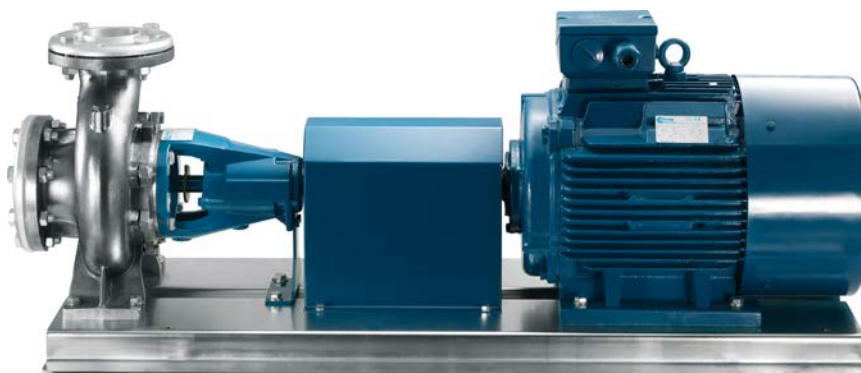

CAX-4CAX with motor
counterflanges supplied separately

Shaft seals versions

The pumps can be provided on request with gland packing instead of mechanical seal.



CA-CAX-4CA-4CAX
mechanical seal



CAT-CATX-4CAT-4CATX
gland packing seal

CM-CMG-CA-4CA

Centrifugal Flanged
EN 733

CM: Front suction close-coupled centrifugal pumps with close impeller mounted on IE3 motor shaft extension. Pump casing with axial suction and radial delivery on top, main dimensions and performance according to EN 733.

CMG-CMGX: Front suction centrifugal pumps connected to IE3 standard motor (stub-shaft construction). Pump casing with axial suction and radial delivery on top, main dimensions and performance according to EN 733.

CA-CAX-4CA-4CAX: Single-stage end-suction centrifugal frame-mounted pumps. Dimensions in accordance with EN 733.

TYPE	2 POLES							4 POLES			
	CM	CMG	CMGX	CA	CAT CAX CATX	Flow rate	Head	4CA 4CAT	4CAX 4CATX	Flow rate	Head
						m ³ /h	m			m ³ /h	m
32-160C	■	-	-	■	■	6 ÷ 21	22,8 ÷ 14	■	■	1,5 ÷ 12	5,9 ÷ 2,6
32-160B	■	-	-	■	■	6 ÷ 24	27,7 ÷ 17	■	■	1,5 ÷ 12	7,2 ÷ 3,6
32-160A	■	-	-	■	■	6 ÷ 27	36,2 ÷ 22,1	■	■	1,5 ÷ 15	8,8 ÷ 4
32-200C	■	-	-	■	■	6 ÷ 27	40,3 ÷ 28,7	■	■	3 ÷ 18	10,8 ÷ 4,2
32-200B1	■	-	-	-	-	6 ÷ 27	48 ÷ 37,9	-	-	-	-
32-200B	■	-	-	■	■	6 ÷ 30	48 ÷ 35,4	■	■	3 ÷ 18	12,7 ÷ 6,3
32-200A1	■	-	-	-	-	6 ÷ 30	58,3 ÷ 46,6	-	-	-	-
32-200A	■	-	-	■	■	6 ÷ 33	58,3 ÷ 44,3	■	■	3 ÷ 21	15,7 ÷ 6,8
32-250C	■	-	-	■	■	6 ÷ 27	72 ÷ 61,3	■	■	3 ÷ 21	17,2 ÷ 6,5
32-250B	■	-	-	■	■	7,5 ÷ 27	84 ÷ 73,2	■	■	3 ÷ 21	20 ÷ 8,3
32-250A1	■	-	-	-	-	7,5 ÷ 27	93,6 ÷ 85,3	-	-	-	-
32-250A	■	-	-	■	■	7,5 ÷ 27	93,6 ÷ 85,5	■	■	3 ÷ 21	22,2 ÷ 9,1
40-125C	■	-	-	■	■	9 ÷ 36	18,5 ÷ 9,4	■	■	4,5 ÷ 21	4,4 ÷ 2
40-125B	■	-	-	■	■	9 ÷ 39	23,4 ÷ 13,2	■	■	4,5 ÷ 21	5,5 ÷ 3,3
40-125A	■	-	-	■	■	9 ÷ 42	27,6 ÷ 16,8	■	■	4,5 ÷ 24	6,3 ÷ 3,4
40-160B	■	-	-	■	■	9 ÷ 36	29,2 ÷ 20,5	■	■	4,5 ÷ 24	7,5 ÷ 2,5
40-160A	■	-	-	■	■	9 ÷ 42	34,9 ÷ 23,4	■	■	4,5 ÷ 24	8,9 ÷ 4,5
40-160AP	■	-	-	■	■	9 ÷ 48	39,8 ÷ 25,3	■	■	4,5 ÷ 24	11,1 ÷ 6,8
40-200B1	■	-	-	-	-	9 ÷ 39	45,5 ÷ 32,3	-	-	-	-
40-200B	■	-	-	■	■	9 ÷ 42	45,5 ÷ 29,4	■	■	6 ÷ 24	11,4 ÷ 4,7
40-200A1	■	-	-	-	-	9 ÷ 39	56,5 ÷ 44,4	-	-	-	-
40-200A	■	-	-	■	■	9 ÷ 42	56,5 ÷ 41,6	■	■	6 ÷ 24	13,9 ÷ 8,3
40-200AP	■	-	-	■	■	9 ÷ 45	61,4 ÷ 42,2	■	■	6 ÷ 24	14,9 ÷ 9,4
40-250C	■	-	-	■	■	9 ÷ 36	64,4 ÷ 55,4	■	■	9 ÷ 27	15,2 ÷ 6,6
40-250B	■	-	-	■	■	9 ÷ 39	79,9 ÷ 62,1	■	■	9 ÷ 30	18,2 ÷ 8,3
40-250A1	■	-	-	-	-	9 ÷ 42	84,6 ÷ 72,8	-	-	-	-
40-250A	■	-	-	■	■	9 ÷ 45	84,6 ÷ 69	■	■	9 ÷ 33	20,8 ÷ 8,4
40-250BM	■	-	-	■	■	9 ÷ 54	93,2 ÷ 72	-	-	-	-
40-250AM	■	-	-	■	■	9 ÷ 60	103 ÷ 77,5	-	-	-	-
50-125B	■	-	-	■	■	12 ÷ 72	20,6 ÷ 9,2	■	■	9 ÷ 42	5,5 ÷ 2,1
50-125A	■	-	-	■	■	12 ÷ 72	24,3 ÷ 14,2	■	■	9 ÷ 45	6,4 ÷ 2,9
50-160B1	■	-	-	-	-	21 ÷ 66	33,5 ÷ 21,5	-	-	-	-
50-160B	■	-	-	■	■	21 ÷ 72	33,5 ÷ 18,9	■	■	9 ÷ 42	8 ÷ 2,3
50-160A1	■	-	-	-	-	21 ÷ 72	39,8 ÷ 27,6	-	-	-	-
50-160A	■	-	-	■	■	21 ÷ 78	39,8 ÷ 25,4	■	■	9 ÷ 48	9,4 ÷ 3,1
50-200C	■	-	-	■	■	24 ÷ 72	49,7 ÷ 28,9	■	■	9 ÷ 39	12 ÷ 3,2
50-200B	■	-	-	■	■	24 ÷ 72	54,6 ÷ 35	■	■	10,5 ÷ 42	13,1 ÷ 4,2
50-200A1	■	-	-	-	-	24 ÷ 78	61,8 ÷ 39,8	-	-	-	-



TYPE	2 POLES							4 POLES			
	CM	CMG	CMGX	CA	CAT CAX CATX	Flow rate	Head	4CA 4CAT	4CAX 4CATX	Flow rate	Head
						m³/h	m			m³/h	m
50-200A	■	-	-	■	■	24 ÷ 78	61,8 ÷ 39,8	■	■	10,5 ÷ 45	14,7 ÷ 4,6
50-250C1	■	-	-	-	-	27 ÷ 60	68,2 ÷ 56,2	-	-	-	-
50-250C	■	-	-	■	■	27 ÷ 66	68,2 ÷ 52,1	■	■	12 ÷ 45	17,7 ÷ 7,5
50-250B	■	-	-	■	■	27 ÷ 72	78,4 ÷ 58,5	■	■	12 ÷ 48	20 ÷ 8,2
50-250A	■	-	-	■	■	27 ÷ 78	88,3 ÷ 61,8	■	■	12 ÷ 54	22,9 ÷ 8,4
50-315DN	-	-	-	■	-	42 ÷ 132	90,4 ÷ 73,4	-	-	-	-
50-315C	-	-	-	-	-	-	-	■	■	18 ÷ 84	24,7 ÷ 16,8
50-315CN	-	-	-	■	-	42 ÷ 132	105 ÷ 88,7	-	-	-	-
50-315B	-	-	-	-	-	-	-	■	■	18 - 90	31,4 - 21,6
50-315BN	-	-	-	■	-	42 ÷ 144	124,3 ÷ 103,5	-	-	-	-
50-315A	-	-	-	-	-	-	-	■	■	18 - 96	37,2 - 25,1
50-315AN	-	-	-	■	-	42 ÷ 144	146,9 ÷ 125,8	-	-	-	-
65-125B1	■	-	-	-	-	30 ÷ 108	20,6 ÷ 15	-	-	-	-
65-125B	■	-	-	■	■	30 ÷ 120	20,6 ÷ 13,1	■	■	18 ÷ 60	5,1 ÷ 2,8
65-125A1	■	-	-	-	-	30 ÷ 120	25,2 ÷ 18,8	-	-	-	-
65-125A	■	-	-	■	■	30 ÷ 132	25,2 ÷ 16,8	■	■	18 ÷ 72	6,3 ÷ 3
65-160C	■	-	-	■	■	42 ÷ 144	30,6 ÷ 13,9	■	■	24 ÷ 78	7,6 ÷ 2,9
65-160B	■	-	-	■	■	42 ÷ 144	35,1 ÷ 20,4	■	■	24 ÷ 78	8,6 ÷ 3,6
65-160A1	■	-	-	-	-	42 ÷ 138	42,5 ÷ 31,7	-	-	-	-
65-160A	■	-	-	■	■	42 ÷ 144	42,5 ÷ 30,9	■	■	24 ÷ 84	9,9 ÷ 4,6
65-200C1	■	-	-	-	-	54 ÷ 132	46,1 ÷ 28,9	-	-	-	-
65-200C	■	-	-	■	■	54 ÷ 138	46,1 ÷ 26,8	■	■	27 ÷ 84	11,6 ÷ 5
65-200B	■	-	-	■	■	54 ÷ 144	53,9 ÷ 34,6	■	■	27 ÷ 84	13,1 ÷ 7
65-200A	■	-	-	■	■	54 ÷ 144	61,8 ÷ 44,4	■	■	27 ÷ 84	14,8 ÷ 9,3
65-250B	■	-	-	■	■	54 ÷ 144	80,6 ÷ 47,3	■	■	27 ÷ 84	21 ÷ 8,7
65-250A	■	-	-	■	■	54 ÷ 150	91,6 ÷ 57,9	■	■	30 ÷ 90	22,9 ÷ 8,8
65-315CM	-	-	-	-	-	-	-	■	■	27 ÷ 126	23,5 ÷ 13,9
65-315CN	-	-	-	■	-	54 ÷ 180	96,5 ÷ 80,8	-	-	-	-
65-315BM	-	-	-	-	-	-	-	■	■	27 ÷ 132	28,9 ÷ 17,2
65-315BN	-	-	-	■	-	54 ÷ 195	117,9 ÷ 96,3	-	-	-	-
65-315AM	-	-	-	-	-	-	-	■	■	27 ÷ 138	34 ÷ 18,2
65-315AN	-	-	-	■	-	54 ÷ 210	138,8 ÷ 110,4	-	-	-	-
80-160E	■	-	-	■	■	66 ÷ 168	22,9 ÷ 13,7	■	■	24 ÷ 96	5,7 ÷ 2,2
80-160D	■	-	-	■	■	66 ÷ 180	27,3 ÷ 16,4	■	■	27 ÷ 102	6,8 ÷ 2,6
80-160C1	■	-	-	-	-	66 ÷ 195	30,9 ÷ 18,4	-	-	-	-
80-160C	■	-	-	■	■	66 ÷ 195	30,9 ÷ 18,4	■	■	30 ÷ 108	7,4 ÷ 3,1
80-160B	■	-	-	■	■	66 ÷ 210	35,9 ÷ 22	■	■	33 ÷ 120	8,9 ÷ 3,5
80-160A	■	-	-	■	■	66 ÷ 225	40,5 ÷ 23,9	■	■	36 ÷ 132	9,8 ÷ 3,8
80-200B	■	-	-	■	■	72 ÷ 225	54,5 ÷ 38,5	■	■	42 ÷ 132	13,1 ÷ 7,1
80-200A	■	-	-	■	■	72 ÷ 240	61,7 ÷ 43,9	■	■	42 ÷ 144	14,7 ÷ 7,5
80-250B	-	■	■	■	■	96 ÷ 225	80 ÷ 58,8	■	■	42 ÷ 132	19,2 ÷ 11,1
80-250A	-	■	■	■	■	96 ÷ 240	92,8 ÷ 65,2	■	■	42 ÷ 144	22,9 ÷ 12,6
80-315B	-	-	-	-	-	-	-	■	■	42 ÷ 150	28,3 ÷ 19,9
80-315A	-	-	-	-	-	-	-	■	■	42 ÷ 168	35 ÷ 23,7
100-160B	■	-	-	-	-	96 ÷ 330	40,7 ÷ 25,7	-	-	-	-
100-160A	■	-	-	-	-	96 ÷ 330	45,1 ÷ 31,9	-	-	-	-
100-200D	-	-	-	■	■	108 ÷ 300	43,1 ÷ 26,6	■	■	48 ÷ 168	10,8 ÷ 4,8
100-200C	-	-	-	■	■	108 ÷ 330	48,4 ÷ 28,1	■	■	48 ÷ 168	12 ÷ 6,3
100-200B	-	■	■	■	■	108 ÷ 330	56,8 ÷ 39,7	■	■	48 ÷ 180	13,6 ÷ 7,8
100-200A	-	■	■	■	■	108 ÷ 360	62,2 ÷ 42,5	■	■	48 ÷ 192	15,4 ÷ 9,1
100-250E	-	-	-	-	-	-	-	■	■	60 ÷ 180	16,9 ÷ 11,4
100-250D	-	-	-	-	-	-	-	■	■	60 ÷ 192	19,6 ÷ 12,7
100-250C	-	■	■	■	■	120 ÷ 300	73,2 ÷ 61	-	-	-	-
100-250B	-	■	■	■	■	120 ÷ 330	83,7 ÷ 67,6	-	-	-	-



TYPE	2 POLES						4 POLES					
	CM	CMG	CMGX	CA	CAT CAX CATX	Flow rate	Head	4CA 4CAT	4CAX 4CATX	Flow rate	Head	
						m ³ /h	m			m ³ /h	m	
100-250A	-	■	■	■	■	120 ÷ 360	93,9 ÷ 73,2	■	■	60 ÷ 204	22,3 ÷ 13,8	
100-315B	-	-	-	-	-	-	-	■	■	72 ÷ 216	31,4 ÷ 17,9	
100-315A	-	-	-	-	-	-	-	■	■	72 ÷ 216	36,5 ÷ 23,1	
100-400C	-	-	-	-	-	-	-	■	■	84 ÷ 228	40,6 ÷ 25,8	
100-400B	-	-	-	-	-	-	-	■	■	84 ÷ 240	48,7 ÷ 31,6	
100-400A	-	-	-	-	-	-	-	■	■	84 ÷ 252	56 ÷ 36,7	
125-250B	-	-	-	-	-	-	-	■	■	102 ÷ 252	20,2 ÷ 11,1	
125-250A	-	-	-	-	-	-	-	■	■	102 ÷ 276	24 ÷ 14,7	
125-315C	-	-	-	-	-	-	-	■	■	120 ÷ 348	25,8 ÷ 15,7	
125-315B	-	-	-	-	-	-	-	■	■	120 ÷ 372	33 ÷ 22,2	
125-315A	-	-	-	-	-	-	-	■	■	120 ÷ 372	39,6 ÷ 28,2	
125-400C	-	-	-	-	-	-	-	■	■	120 ÷ 372	47,6 ÷ 33,8	
125-400B	-	-	-	-	-	-	-	■	■	120 ÷ 396	54,5 ÷ 39,1	
125-400A	-	-	-	-	-	-	-	■	■	120 ÷ 396	59,5 ÷ 45	
150-315D	-	-	-	-	-	-	-	■	■	144 ÷ 444	28,3 ÷ 19,6	
150-315C	-	-	-	-	-	-	-	■	■	144 ÷ 492	32,2 ÷ 21,8	
150-315B	-	-	-	-	-	-	-	■	■	144 ÷ 540	36,3 ÷ 23,6	
150-315A	-	-	-	-	-	-	-	■	■	144 ÷ 564	41 ÷ 27,2	
150-400C	-	-	-	-	-	-	-	■	■	168 ÷ 564	47,8 ÷ 28,7	
150-400B	-	-	-	-	-	-	-	■	■	168 ÷ 588	54,4 ÷ 34,3	
150-400A	-	-	-	-	-	-	-	■	■	168 ÷ 612	60,3 ÷ 39,8	
Not envisaged in the EN 733 standard												
200-315D	-	-	-	-	-	-	-	■	■	200 ÷ 800	21,7 ÷ 12,5	
200-315C	-	-	-	-	-	-	-	■	■	200 ÷ 850	26,6 ÷ 14,6	
200-315B	-	-	-	-	-	-	-	■	■	200 ÷ 900	33,4 ÷ 16,7	
200-315A	-	-	-	-	-	-	-	■	■	200 ÷ 900	35,9 ÷ 19,8	
200-400C	-	-	-	-	-	-	-	■	■	200 ÷ 800	44,1 ÷ 31,5	
200-400B	-	-	-	-	-	-	-	■	■	200 ÷ 850	50,8 ÷ 36,6	
200-400A	-	-	-	-	-	-	-	■	■	200 ÷ 900	58,5 ÷ 44	
250-315C	-	-	-	-	-	-	-	■	■	250 ÷ 1100	25,5 ÷ 16,8	
250-315B	-	-	-	-	-	-	-	■	■	250 ÷ 1170	33 ÷ 19	
250-315A	-	-	-	-	-	-	-	■	■	250 ÷ 1200	35 ÷ 20	
250-400D	-	-	-	-	-	-	-	■	■	250 ÷ 1300	39,9 ÷ 24,3	
250-400C	-	-	-	-	-	-	-	■	■	250 ÷ 1400	45,8 ÷ 27,4	
250-400B	-	-	-	-	-	-	-	■	■	250 ÷ 1500	51,7 ÷ 30,3	
250-400A	-	-	-	-	-	-	-	■	■	250 ÷ 1600	57,4 ÷ 31,7	



CA-4CA Series

Models list and materials

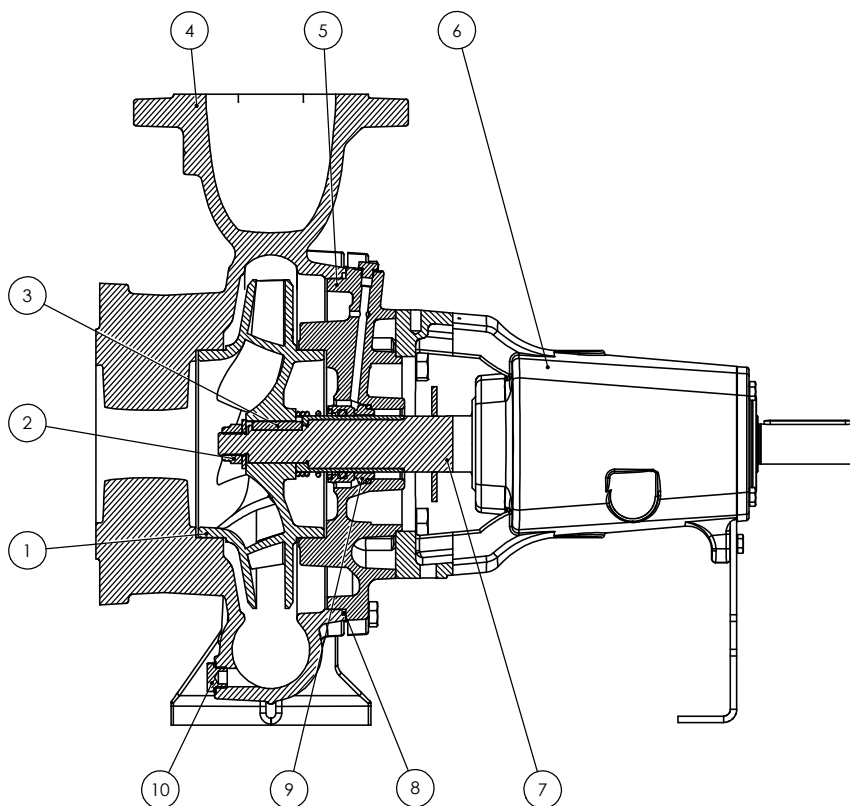

POS. N.	DENOMINATION	VERSION	MATERIAL	REFERENCE STANDARDS	
				EUROPE	USA
1	Impeller	Standard	Cast iron G20	GJL-200 (JL1030)	ASTM Class 30
		B	Bronze	CuSn10-C (CC480K)	UNS C90700
		X	Stainless steel	X5CrNiMo17-12-2/ 1.4401	AISI 316
2	Impeller lock nut and washer		Stainless steel	X5CrNiMo17-12-2/ 1.4401	AISI 316
3	Impeller key		Stainless steel	X5CrNiMo17-12-2/ 1.4401	AISI 316
4	Volute casing	Up to 80-200	Cast iron G20	GJL-200 (JL1030)	ASTM Class 30
		From 80-250	Cast iron G25	GJL-250 (JL1040)	ASTM Class 35
		X	Stainless steel	X5CrNiMo17-12-2/ 1.4401	AISI 316
5	Casing cover	Standard	Cast iron G20	GJL-200 (JL1030)	ASTM Class 30
		X	Stainless steel	X5CrNiMo17-12-2/ 1.4401	AISI 316
6	Bracket		Cast iron G20	GJL-200 (JL1030)	ASTM Class 30
7	Shaft		Stainless steel	X5CrNiMo17-12-2/ 1.4401	AISI 316
8	O-ring	Standard	NBR		
		E	EPDM		
		V	FKM		
9	Mechanical seal		(Search for the material in the mechanical seal table)		
10	Fill and drain plugs	Standard	Brass	CU ZN 40 PB2 UNI 5705/65	C37700
		X	Stainless steel	X5CrNiMo17-12-2/ 1.4401	AISI 316

TYPE - 60 Hz	P2	Motor Size	Q (m³/h - l/min)														
			0	6	7,5	9	12	15	18	21	24	27	30	33			
	kW	0	100	125	150	200	250	300	350	400	450	500	550				
			H (m) <i>pump input power (kW)</i>														
32-160C	1,5	90S	23,1 <i>0,53</i>	23,0 <i>0,92</i>	22,7 <i>1,01</i>	22,2 <i>1,09</i>	20,8 <i>1,25</i>	18,9 <i>1,39</i>	16,5 <i>1,52</i>	13,6 <i>1,63</i>							
32-160B	2,2	90L	28,0 <i>0,76</i>	28,1 <i>1,23</i>	27,8 <i>1,34</i>	27,3 <i>1,45</i>	26,1 <i>1,65</i>	24,6 <i>1,83</i>	22,5 <i>2,00</i>	19,6 <i>2,14</i>	16,3 <i>2,26</i>						
32-160A	3	100L	35,3 <i>1,10</i>	35,1 <i>1,64</i>	34,9 <i>1,79</i>	34,5 <i>1,92</i>	33,4 <i>2,18</i>	32,3 <i>2,42</i>	30,4 <i>2,65</i>	27,8 <i>2,84</i>	24,5 <i>3,02</i>	21,0 <i>3,17</i>					
32-200C	4	112M	39,3 <i>1,59</i>	39,3 <i>2,27</i>	39,2 <i>2,46</i>	39,0 <i>2,64</i>	38,3 <i>2,97</i>	37,3 <i>3,31</i>	35,7 <i>3,61</i>	33,4 <i>3,88</i>	30,5 <i>4,13</i>	28,2 <i>4,34</i>					
32-200B	5,5 7,5	132S 132S	47,7 <i>2,23</i>	47,6 <i>3,05</i>	47,6 <i>3,26</i>	47,5 <i>3,49</i>	46,9 <i>3,91</i>	45,9 <i>4,32</i>	44,7 <i>4,70</i>	42,9 <i>5,05</i>	40,5 <i>5,40</i>	37,4 <i>5,70</i>	35,7 <i>5,98</i>				
32-200A	7,5	132S	58,0 <i>2,90</i>	57,5 <i>3,84</i>	57,5 <i>4,09</i>	57,3 <i>4,35</i>	56,7 <i>4,86</i>	55,7 <i>5,34</i>	54,5 <i>5,80</i>	52,9 <i>6,26</i>	50,9 <i>6,67</i>	48,3 <i>7,00</i>	45,1 <i>7,37</i>	43,0 <i>7,74</i>			
32-250C	11	160M	76,2 <i>4,06</i>		74,3 <i>5,60</i>	74,0 <i>5,94</i>	72,9 <i>6,53</i>	71,2 <i>7,08</i>	69,0 <i>7,56</i>	66,4 <i>8,00</i>	63,4 <i>8,48</i>	59,5 <i>8,93</i>					
32-250B	11	160M	87,6 <i>5,29</i>		85,6 <i>7,03</i>	85,4 <i>7,39</i>	84,6 <i>8,09</i>	83,2 <i>8,76</i>	81,1 <i>9,37</i>	78,6 <i>9,96</i>	75,7 <i>10,50</i>	72,3 <i>11,00</i>					
32-250A	15	160M	96,7 <i>6,27</i>		95,1 <i>8,20</i>	94,9 <i>8,61</i>	94,4 <i>9,42</i>	93,2 <i>10,18</i>	91,4 <i>10,92</i>	89,1 <i>11,61</i>	86,4 <i>12,27</i>	83,2 <i>12,85</i>					

TYPE - 60 Hz	P2	Motor Size	Q (m³/h - l/min)																
			0	9	12	15	18	21	24	27	30	33	36	39	42	45	48	54	60
	kW	0	150	200	250	300	350	400	450	500	550	600	650	700	750	800	900	1000	
			H (m) <i>pump input power (kW)</i>																
40-125C	1,5 2,2	90S 90L	17,7 <i>0,54</i>	18,6 <i>0,97</i>	18,4 <i>1,11</i>	18,0 <i>1,23</i>	17,3 <i>1,33</i>	16,4 <i>1,43</i>	15,3 <i>1,50</i>	14,0 <i>1,55</i>	12,6 <i>1,59</i>	10,9 <i>1,60</i>	8,9 <i>1,60</i>						
40-125B	2,2 3	90L 100L	22,9 <i>1,79</i>	24,1 <i>1,33</i>	24,1 <i>1,52</i>	23,7 <i>1,68</i>	23,1 <i>1,83</i>	22,3 <i>1,96</i>	21,2 <i>2,08</i>	20,1 <i>2,17</i>	18,7 <i>2,24</i>	17,1 <i>2,29</i>	15,1 <i>2,32</i>	12,9 <i>2,34</i>					
40-125A	3	100L	27,3 <i>1,08</i>	28,4 <i>1,67</i>	28,4 <i>1,90</i>	28,3 <i>2,10</i>	27,9 <i>2,29</i>	27,2 <i>2,45</i>	26,4 <i>2,59</i>	25,3 <i>2,71</i>	23,9 <i>2,82</i>	22,2 <i>2,91</i>	20,3 <i>2,98</i>	18,2 <i>3,02</i>	16,0 <i>3,05</i>				
40-160B	3 4	100L 112M	28,3 <i>1,25</i>	28,9 <i>1,95</i>	28,9 <i>2,16</i>	28,8 <i>2,38</i>	28,5 <i>2,59</i>	27,7 <i>2,77</i>	26,6 <i>2,94</i>	25,4 <i>3,07</i>	23,9 <i>3,18</i>	22,2 <i>3,26</i>	20,1 <i>3,33</i>						
40-160A	4	112M	32,7 <i>1,42</i>	33,8 <i>2,22</i>	33,9 <i>2,47</i>	33,9 <i>2,72</i>	33,6 <i>2,95</i>	33,0 <i>3,18</i>	32,2 <i>3,40</i>	31,2 <i>3,60</i>	30,0 <i>3,78</i>	28,4 <i>3,91</i>	26,6 <i>4,02</i>	24,6 <i>4,11</i>	22,3 <i>4,19</i>				
40-160AP	5,5	132S	38,2 <i>1,96</i>	39,5 <i>2,88</i>	39,8 <i>3,18</i>	39,7 <i>3,48</i>	39,4 <i>3,76</i>	38,8 <i>4,02</i>	38,0 <i>4,26</i>	37,0 <i>4,47</i>	35,7 <i>4,66</i>	34,1 <i>4,84</i>	32,5 <i>5,00</i>	30,8 <i>5,14</i>	28,8 <i>5,26</i>	26,6 <i>5,36</i>	24,2 <i>5,43</i>		
40-200B	5,5 7,5	132S 132S	44,7 <i>2,31</i>	45,3 <i>3,35</i>	45,2 <i>3,71</i>	44,9 <i>4,06</i>	44,2 <i>4,42</i>	43,2 <i>4,71</i>	41,9 <i>4,98</i>	40,4 <i>5,26</i>	38,4 <i>5,49</i>	36,0 <i>5,70</i>	33,3 <i>5,89</i>	30,5 <i>6,04</i>	27,2 <i>6,11</i>				
40-200A	7,5 11	132S 160M	55,2 <i>3,25</i>	56,3 <i>4,46</i>	56,3 <i>4,91</i>	56,4 <i>5,35</i>	55,9 <i>5,76</i>	55,0 <i>6,16</i>	53,8 <i>6,53</i>	52,4 <i>6,87</i>	50,7 <i>7,20</i>	48,6 <i>7,50</i>	46,1 <i>7,77</i>	43,4 <i>8,03</i>	40,1 <i>8,24</i>				
40-200AP	11	160M	60,2 <i>3,63</i>	60,8 <i>4,95</i>	60,9 <i>5,45</i>	60,9 <i>5,94</i>	60,5 <i>6,39</i>	59,6 <i>6,82</i>	58,5 <i>7,22</i>	57,2 <i>7,60</i>	55,7 <i>7,96</i>	53,9 <i>8,29</i>	51,6 <i>8,61</i>	48,9 <i>8,90</i>	45,8 <i>9,17</i>	42,8 <i>9,41</i>			
40-250C	11	160M	63,2 <i>3,99</i>	65,1 <i>5,67</i>	65,3 <i>6,23</i>	65,2 <i>6,79</i>	64,8 <i>7,32</i>	64,2 <i>7,85</i>	63,3 <i>8,36</i>	61,4 <i>8,79</i>	59,0 <i>9,22</i>	56,3 <i>9,67</i>	53,3 <i>10,11</i>						
40-250B	11	160M	71,7 <i>4,97</i>	73,7 <i>6,76</i>	74,1 <i>7,41</i>	74,0 <i>8,08</i>	73,7 <i>8,68</i>	73,1 <i>9,23</i>	71,7 <i>9,75</i>	70,1 <i>10,26</i>	68,5 <i>10,79</i>	66,2 <i>11,32</i>	63,2 <i>11,84</i>	60,0 <i>12,36</i>					
40-250A	15	160M	81,3 <i>6,31</i>	83,7 <i>8,36</i>	84,2 <i>9,11</i>	84,3 <i>9,80</i>	83,9 <i>10,47</i>	82,8 <i>11,13</i>	81,6 <i>11,78</i>	80,6 <i>12,42</i>	79,4 <i>13,08</i>	77,9 <i>13,74</i>	75,4 <i>14,34</i>	72,4 <i>14,89</i>	68,9 <i>15,42</i>	65,1 <i>15,93</i>			
40-250BM max 14 bar	18,5	160L	89,8 <i>7,12</i>	91,8 <i>9,03</i>	91,8 <i>9,70</i>	91,4 <i>10,39</i>	91,0 <i>11,08</i>	90,6 <i>11,78</i>	90,0 <i>12,49</i>	89,4 <i>13,25</i>	88,8 <i>14,00</i>	88,1 <i>14,69</i>	87,3 <i>15,34</i>	85,7 <i>15,97</i>	83,2 <i>16,58</i>	80,1 <i>17,17</i>	76,5 <i>17,77</i>	68,1 <i>18,93</i>	
40-250AM max 14 bar	22	180M	101,0 <i>8,17</i>	102,7 <i>10,36</i>	102,8 <i>11,11</i>	102,8 <i>11,86</i>	102,6 <i>12,62</i>	102,2 <i>13,46</i>	101,7 <i>14,29</i>	101,1 <i>15,10</i>	100,2 <i>15,89</i>	99,1 <i>16,65</i>	98,0 <i>17,43</i>	96,6 <i>18,20</i>	94,8 <i>18,91</i>	92,5 <i>19,59</i>	89,4 <i>20,27</i>	81,7 <i>21,57</i>	72,6 <i>22,71</i>



CA-CAX ~ EN 733

TYPE - 60 Hz	P2	Motor Size	Q (m³/h - l/min)																			
			0	12	15	18	21	24	27	30	33	36	39	42	45	48	54	60	66	72	78	
			0	200	250	300	350	400	450	500	550	600	650	700	750	800	900	1000	1100	1200	1300	
			H (m)																			
			pump input power (kW)																			
50-125B	3	100L	20,2 <u>1,29</u>	20,6 <u>1,68</u>	20,5 <u>1,82</u>	20,3 <u>1,96</u>	20,1 <u>2,10</u>	19,8 <u>2,23</u>	19,5 <u>2,36</u>	19,1 <u>2,47</u>	18,7 <u>2,57</u>	18,3 <u>2,67</u>	17,8 <u>2,75</u>	17,3 <u>2,84</u>	16,7 <u>2,91</u>	16,1 <u>2,98</u>	14,5 <u>3,09</u>	12,6 <u>3,15</u>	10,5 <u>3,17</u>	8,4 <u>3,18</u>		
50-125A	4	112M	23,7 <u>1,48</u>	24,6 <u>2,05</u>	24,5 <u>2,23</u>	24,5 <u>2,40</u>	24,3 <u>2,55</u>	24,1 <u>2,70</u>	23,9 <u>2,86</u>	23,6 <u>3,02</u>	23,3 <u>3,18</u>	22,9 <u>3,31</u>	22,4 <u>3,44</u>	21,9 <u>3,56</u>	21,3 <u>3,66</u>	20,6 <u>3,76</u>	19,2 <u>3,92</u>	17,5 <u>4,04</u>	15,4 <u>4,12</u>	13,4 <u>4,18</u>		
50-160B	5,5	132S	34,2 <u>2,10</u>				35,1 <u>3,96</u>	34,8 <u>4,20</u>	34,4 <u>4,43</u>	33,8 <u>4,64</u>	33,1 <u>4,84</u>	32,4 <u>5,03</u>	31,6 <u>5,20</u>	30,8 <u>5,36</u>	29,8 <u>5,49</u>	28,8 <u>5,60</u>	26,6 <u>5,77</u>	24,0 <u>5,86</u>	21,0 <u>5,89</u>	17,6 <u>5,81</u>		
50-160A	7,5	132S	40,5 <u>2,71</u>				42,4 <u>4,85</u>	42,4 <u>5,14</u>	42,2 <u>5,42</u>	41,9 <u>5,70</u>	41,4 <u>5,97</u>	40,8 <u>6,22</u>	40,2 <u>6,46</u>	39,5 <u>6,68</u>	38,7 <u>6,88</u>	37,8 <u>7,06</u>	35,7 <u>7,37</u>	33,2 <u>7,60</u>	30,6 <u>7,76</u>	27,9 <u>7,84</u>	24,5 <u>7,89</u>	
50-200C	11	160M	48,1 <u>2,84</u>					50,2 <u>6,10</u>	49,7 <u>6,46</u>	49,0 <u>6,79</u>	48,2 <u>7,08</u>	47,3 <u>7,34</u>	46,3 <u>7,61</u>	45,2 <u>7,89</u>	44,0 <u>8,14</u>	42,6 <u>8,36</u>	39,4 <u>8,70</u>	35,6 <u>8,96</u>	30,8 <u>9,12</u>	25,2 <u>9,19</u>		
50-200B	11	160M	54,9 <u>3,77</u>					57,1 <u>7,35</u>	56,7 <u>7,74</u>	56,1 <u>8,12</u>	55,3 <u>8,48</u>	54,5 <u>8,81</u>	53,5 <u>9,13</u>	52,4 <u>9,43</u>	51,3 <u>9,72</u>	50,0 <u>9,99</u>	47,0 <u>10,44</u>	43,3 <u>10,79</u>	39,0 <u>11,07</u>	34,4 <u>11,26</u>		
50-200A	15	160M	62,0 <u>4,39</u>					64,9 <u>8,40</u>	64,6 <u>8,87</u>	64,1 <u>9,35</u>	63,5 <u>9,81</u>	62,7 <u>10,21</u>	61,8 <u>10,57</u>	60,7 <u>10,91</u>	59,6 <u>11,26</u>	58,3 <u>11,60</u>	55,5 <u>12,19</u>	52,3 <u>12,67</u>	48,1 <u>13,08</u>	43,5 <u>13,40</u>	38,4 <u>13,65</u>	
50-250C	15	160M	67,8 <u>4,54</u>						66,7 <u>9,60</u>	66,1 <u>10,13</u>	65,4 <u>10,64</u>	64,6 <u>11,13</u>	63,8 <u>11,60</u>	62,9 <u>12,04</u>	61,7 <u>12,47</u>	60,3 <u>12,88</u>	56,9 <u>13,66</u>	53,3 <u>14,38</u>	49,3 <u>15,04</u>			
50-250B	18,5	160L	78,1 <u>6,13</u>						78,1 <u>11,96</u>	77,4 <u>12,59</u>	76,7 <u>13,18</u>	75,9 <u>13,75</u>	74,1 <u>14,29</u>	72,9 <u>14,82</u>	71,5 <u>15,33</u>	68,3 <u>15,84</u>	64,3 <u>16,83</u>	59,9 <u>17,74</u>	55,6 <u>18,59</u>			
50-250A	22	180M	87,2 <u>7,03</u>							87,1 <u>13,27</u>	86,5 <u>14,00</u>	85,9 <u>14,71</u>	85,3 <u>15,37</u>	84,8 <u>16,00</u>	84,1 <u>16,61</u>	83,2 <u>17,20</u>	82,2 <u>17,76</u>	79,6 <u>18,83</u>	76,2 <u>19,84</u>	72,1 <u>20,79</u>	67,7 <u>21,72</u>	63,1 <u>22,60</u>

TYPE - 60 Hz	P2	Motor Size	Q (m³/h - l/min)															
			0	42	45	48	54	60	66	72	78	84	96	108	120	132	138	144
			0	700	750	800	900	1000	1100	1200	1300	1400	1600	1800	2000	2200	2300	2400
			H (m)															
			pump input power (kW)															
50-315DN <small>No EN 733; no CAT, CAX, CATX</small>	37	200L	87,8 <u>11,19</u>	90,4 <u>20,11</u>	90,3 <u>20,82</u>	90,2 <u>21,53</u>	89,9 <u>22,91</u>	89,2 <u>24,19</u>	88,2 <u>25,41</u>	87,1 <u>26,59</u>	86,0 <u>27,71</u>	84,8 <u>28,79</u>	82,4 <u>30,91</u>	79,9 <u>32,95</u>	76,9 <u>34,81</u>	73,4 <u>36,56</u>		
50-315CN <small>No EN 733; no CAT, CAX, CATX</small>	45	225M	101,8 <u>13,32</u>	105,0 <u>23,97</u>	104,9 <u>24,80</u>	104,8 <u>25,62</u>	104,3 <u>27,25</u>	103,7 <u>28,79</u>	102,7 <u>30,21</u>	101,5 <u>31,54</u>	100,3 <u>32,85</u>	99,1 <u>34,15</u>	96,7 <u>36,68</u>	94,1 <u>39,07</u>	91,3 <u>41,26</u>	88,7 <u>43,26</u>		
50-315BN <small>No EN 733; no CAT, CAX, CATX</small>	55	250M	122,3 <u>17,44</u>	124,3 <u>29,30</u>	124,4 <u>30,29</u>	124,5 <u>31,27</u>	124,7 <u>33,28</u>	124,4 <u>35,14</u>	123,6 <u>36,80</u>	122,5 <u>38,34</u>	121,3 <u>39,85</u>	119,9 <u>41,39</u>	116,6 <u>44,41</u>	113,3 <u>47,32</u>	110,1 <u>50,01</u>	107,1 <u>52,39</u>	105,4 <u>53,60</u>	103,5 <u>54,83</u>
50-315AN <small>No EN 733; no CAT, CAX, CATX</small>	75	280S	146,1 <u>22,75</u>	146,9 <u>35,89</u>	147,1 <u>37,06</u>	147,3 <u>38,23</u>	147,4 <u>40,53</u>	147,3 <u>42,67</u>	146,9 <u>44,71</u>	146,3 <u>46,70</u>	145,3 <u>48,67</u>	144,1 <u>50,61</u>	141,2 <u>54,26</u>	137,9 <u>57,62</u>	134,1 <u>60,84</u>	130,0 <u>63,78</u>	127,9 <u>65,11</u>	125,8 <u>66,34</u>

TYPE - 60 Hz	P2	Motor Size	Q (m³/h - l/min)																				
			0	30	33	36	39	42	45	48	54	60	66	72	78	84	96	108	120	132	138	144	150
			0	500	550	600	650	700	750	800	900	1000	1100	1200	1300	1400	1600	1800	2000	2200	2300	2400	2500
			H (m)																				
			pump input power (kW)																				
65-125B	5,5 7,5	132S 132S	18,2 <u>2,35</u>	19,6 <u>3,52</u>	19,5 <u>3,63</u>	19,4 <u>3,73</u>	19,2 <u>3,82</u>	19,0 <u>3,92</u>	18,8 <u>4,01</u>	18,5 <u>4,10</u>	18,0 <u>4,27</u>	17,7 <u>4,48</u>	17,5 <u>4,71</u>	17,2 <u>4,93</u>	16,9 <u>5,13</u>	16,4 <u>5,31</u>	15,0 <u>5,56</u>	13,7 <u>5,83</u>	11,9 <u>5,88</u>				
65-125A	7,5	132S	23,2 <u>2,95</u>	24,7 <u>4,39</u>	24,7 <u>4,54</u>	24,6 <u>4,70</u>	24,5 <u>4,85</u>	24,4 <u>4,99</u>	24,3 <u>5,14</u>	24,1 <u>5,28</u>	23,8 <u>5,55</u>	23,4 <u>5,80</u>	23,0 <u>6,05</u>	22,7 <u>6,30</u>	22,3 <u>6,52</u>	21,7 <u>6,72</u>	20,4 <u>7,08</u>	19,0 <u>7,40</u>	17,4 <u>7,72</u>	15,1 <u>7,76</u>			
65-160C	11	160M	29,5 <u>3,15</u>					30,7 <u>5,71</u>	30,5 <u>5,91</u>	30,3 <u>6,10</u>	29,8 <u>6,47</u>	29,3 <u>6,83</u>	28,8 <u>7,18</u>	28,2 <u>7,51</u>	27,5 <u>7,79</u>	26,8 <u>8,05</u>	24,9 <u>8,50</u>	22,5 <u>8,83</u>	19,7 <u>9,08</u>	16,8 <u>9,24</u>	15,4 <u>9,28</u>	13,6 <u>9,29</u>	
65-160B	11	160M	33,9 <u>3,86</u>					35,7 <u>6,88</u>	35,6 <u>7,11</u>	35,4 <u>7,34</u>	35,0 <u>7,80</u>	34,5 <u>8,25</u>	34,0 <u>8,66</u>	33,4 <u>9,04</u>	32,7 <u>9,39</u>	32,0 <u>9,72</u>	30,3 <u>10,30</u>	28,0 <u>10,76</u>	25,3 <u>11,11</u>	22,1 <u>11,37</u>	20,4 <u>11,46</u>	19,0 <u>11,53</u>	
65-160A	15	160M	41,6 <u>4,80</u>					44,1 <u>8,63</u>	44,0 <u>8,92</u>	43,9 <u>9,22</u>	43,7 <u>9,80</u>	43,3 <u>10,39</u>	42,8 <u>10,94</u>	42,3 <u>11,45</u>	41,7 <u>11,91</u>	41,1 <u>12,34</u>	39,8 <u>13,08</u>	37,8 <u>13,84</u>	35,3 <u>14,52</u>	32,3 <u>15,06</u>	30,7 <u>15,29</u>	28,9 <u>15,48</u>	
65-200C	15	160M	44,8 <u>4,49</u>								45,2 <u>10,62</u>	44,5 <u>11,19</u>	43,6 <u>11,78</u>	42,7 <u>12,34</u>	41,8 <u>12,85</u>	41,0 <u>13,31</u>	38,6 <u>14,08</u>	35,0 <u>14,67</u>	30,9 <u>15,12</u>	27,0 <u>15,43</u>	25,5 <u>15,53</u>		
65-200B	18,5 22,5	160L 180M	52,1 <u>5,55</u>								53,8 <u>12,73</u>	53,0 <u>13,50</u>	52,3 <u>14,16</u>	51,6 <u>14,74</u>	50,8 <u>15,32</u>	49,9 <u>15,95</u>	47,8 <u>17,03</u>	45,4 <u>17,85</u>	41,4 <u>18,58</u>	37,0 <u>19,13</u>	34,7 <u>19,33</u>	32,6 <u>19,50</u>	
65-200A	22,5	180M	59,0 <u>6,71</u>								61,9 <u>14,86</u>	61,3 <u>15,68</u>	60,6 <u>16,48</u>	60,0 <u>17,26</u>	59,3 <u>18,02</u>	58,6 <u>18,74</u>	56,5 <u>20,01</u>	54,2 <u>21,06</u>	51,4 <u>21,91</u>	46,9 <u>22,74</u>	44,4 <u>23,09</u>	41,8 <u>23,37</u>	
65-250B	30	200L	79,8 <u>8,51</u>								80,8 <u>19,89</u>	79,7 <u>20,96</u>	78,4 <u>21,91</u>	77,0 <u>22,77</u>	75,5 <u>23,59</u>	73,9 <u>24,43</u>	70,4 <u>25,96</u>	66,3 <u>27,20</u>	61,2 <u>28,06</u>	54,9 <u>28,90</u>	51,5 <u>29,24</u>	49,0 <u>29,48</u>	
65-250A	37	200L	90,2 <u>10,18</u>								91,8 <u>23,00</u>	90,8 <u>24,23</u>	89,6 <u>25,41</u>	88,1 <u>26,54</u>	86,5 <u>27,56</u>	85,0 <u>28,41</u>	81,4 <u>29,97</u>	77,0 <u>31,48</u>	72,0 <u>32,60</u>	66,0 <u>33,40</u>	62,6 <u>33,71</u>	60,7 <u>34,07</u>	57,5 <u>34,35</u>



TYPE - 60 Hz	P2	Motor Size	Q (m³/h - l/min)																				
			0	54	60	66	72	78	84	96	108	120	132	138	144	150	156	168	180	195	210		
			0	900	1000	1100	1200	1300	1400	1600	1800	2000	2200	2300	2400	2500	2600	2800	3000	3250	3500		
kW		H (m) pump input power (kW)																					
65-315CN No CAT, CAX, CATX	55	250M	89,1	94,6	94,6	94,6	94,2	93,7	93,3	92,1	90,4	88,6	86,9	86,1	85,2	84,2	83,1	80,8	78,2				
			<u>14,88</u>	<u>27,27</u>	<u>28,69</u>	<u>30,09</u>	<u>31,43</u>	<u>32,74</u>	<u>34,03</u>	<u>36,56</u>	<u>39,10</u>	<u>41,55</u>	<u>43,80</u>	<u>44,88</u>	<u>45,95</u>	<u>47,04</u>	<u>48,12</u>	<u>50,26</u>	<u>52,38</u>				
65-315BN No CAT, CAX, CATX	75	280S	109,3	113,8	114,0	114,2	114,2	113,9	113,6	112,4	110,7	108,6	106,5	105,4	104,4	103,4	102,5	100,7	98,5	94,8			
			<u>19,73</u>	<u>33,93</u>	<u>35,64</u>	<u>37,33</u>	<u>38,93</u>	<u>40,50</u>	<u>42,10</u>	<u>45,26</u>	<u>48,26</u>	<u>51,13</u>	<u>53,82</u>	<u>55,13</u>	<u>56,45</u>	<u>57,80</u>	<u>59,17</u>	<u>61,90</u>	<u>64,51</u>	<u>67,56</u>			
65-315AN No CAT, CAX, CATX	90	280M	132,5	137,4	137,9	138,3	138,4	138,3	138,1	137,3	135,8	133,8	131,7	130,6	129,5	128,4	127,3	125,2	123,0	120,1	116,3		
			<u>26,42</u>	<u>43,32</u>	<u>45,51</u>	<u>47,69</u>	<u>49,75</u>	<u>51,74</u>	<u>53,71</u>	<u>57,58</u>	<u>61,35</u>	<u>64,98</u>	<u>68,43</u>	<u>70,11</u>	<u>71,78</u>	<u>73,47</u>	<u>75,17</u>	<u>78,50</u>	<u>81,56</u>	<u>84,90</u>	<u>89,60</u>		

TYPE - 60 Hz	P2	Motor Size	Q (m³/h - l/min)																		
			0	66	72	78	84	96	108	120	132	138	144	150	156	168	180	195	210	225	240
			0	1100	1200	1300	1400	1600	1800	2000	2200	2300	2400	2500	2600	2800	3000	3250	3500	3750	4000
kW		H (m) pump input power (kW)																			
80-160E	11	160M	20,7	22,5	21,9	21,3	20,8	19,7	18,8	17,9	16,6	16,0	15,5	15,0	14,6	13,5					
			<u>4,46</u>	<u>7,05</u>	<u>7,17</u>	<u>7,28</u>	<u>7,41</u>	<u>7,69</u>	<u>8,09</u>	<u>8,49</u>	<u>8,69</u>	<u>8,80</u>	<u>8,93</u>	<u>9,06</u>	<u>9,18</u>	<u>9,35</u>					
80-160D	11	160M	23,9	25,9	25,4	24,8	24,3	23,3	22,5	21,8	20,5	19,8	19,1	18,5	18,0	16,9	15,5				
			<u>5,03</u>	<u>8,11</u>	<u>8,30</u>	<u>8,49</u>	<u>8,70</u>	<u>9,18</u>	<u>9,64</u>	<u>10,07</u>	<u>10,40</u>	<u>10,54</u>	<u>10,67</u>	<u>10,82</u>	<u>10,98</u>	<u>11,22</u>	<u>11,34</u>				
80-160C	15	160M	29,4	32,6	32,2	31,8	31,3	30,3	29,3	28,2	27,2	26,6	26,0	25,4	24,8	23,4	21,9	19,2			
			<u>5,73</u>	<u>9,88</u>	<u>10,20</u>	<u>10,51</u>	<u>10,82</u>	<u>11,44</u>	<u>12,05</u>	<u>12,57</u>	<u>12,96</u>	<u>13,16</u>	<u>13,40</u>	<u>13,65</u>	<u>13,88</u>	<u>14,24</u>	<u>14,49</u>	<u>14,56</u>			
80-160B	18,5	160L	34,9	37,9	37,6	37,3	36,9	36,0	35,0	33,9	32,7	32,1	31,5	30,9	30,4	29,2	27,5	24,9	22,3		
			<u>6,98</u>	<u>11,63</u>	<u>12,05</u>	<u>12,44</u>	<u>12,82</u>	<u>13,54</u>	<u>14,25</u>	<u>14,91</u>	<u>15,44</u>	<u>15,66</u>	<u>15,89</u>	<u>16,13</u>	<u>16,38</u>	<u>16,86</u>	<u>17,27</u>	<u>17,65</u>	<u>17,84</u>		
80-160A	22,5	180M	38,8	42,4	42,1	41,8	41,4	40,6	39,7	38,7	37,5	36,8	36,1	35,5	34,9	33,6	32,1	29,8	27,4	24,5	
			<u>7,79</u>	<u>12,99</u>	<u>13,42</u>	<u>13,88</u>	<u>14,39</u>	<u>15,40</u>	<u>16,21</u>	<u>16,88</u>	<u>17,54</u>	<u>17,86</u>	<u>18,17</u>	<u>18,46</u>	<u>18,75</u>	<u>19,27</u>	<u>19,73</u>	<u>20,20</u>	<u>20,54</u>	<u>20,69</u>	
80-200B	30	200L	49,4				53,8	53,0	52,0	51,1	50,2	49,7	49,2	48,7	48,1	47,0	45,6	43,6	40,8	37,6	
			<u>9,37</u>				<u>18,68</u>	<u>20,00</u>	<u>21,30</u>	<u>22,63</u>	<u>23,96</u>	<u>24,56</u>	<u>25,08</u>	<u>25,53</u>	<u>25,94</u>	<u>26,75</u>	<u>27,57</u>	<u>28,51</u>	<u>29,35</u>	<u>30,00</u>	
80-200A	37	200L	56,7				62,1	61,5	60,6	59,7	58,8	58,2	57,7	57,2	56,6	55,4	53,9	51,7	49,4	46,8	43,8
			<u>10,55</u>				<u>21,49</u>	<u>23,09</u>	<u>24,74</u>	<u>26,30</u>	<u>27,78</u>	<u>28,47</u>	<u>29,12</u>	<u>29,71</u>	<u>30,27</u>	<u>31,30</u>	<u>32,34</u>	<u>33,60</u>	<u>34,65</u>	<u>35,49</u>	<u>36,21</u>
80-250B	45	225M	77,2					77,7	76,4	75,2	74,0	73,3	72,6	71,8	70,9	69,1	67,3	64,9	62,3	59,5	
			<u>14,22</u>					<u>32,00</u>	<u>34,32</u>	<u>36,41</u>	<u>37,94</u>	<u>38,70</u>	<u>39,45</u>	<u>40,27</u>	<u>41,09</u>	<u>42,67</u>	<u>44,03</u>	<u>45,51</u>	<u>46,76</u>	<u>47,80</u>	
80-250A	55	250M	90,0					92,0	90,8	89,4	87,9	87,0	86,1	85,1	84,1	81,9	79,7	77,1	74,2	71,0	68,0
			<u>17,04</u>					<u>37,50</u>	<u>39,95</u>	<u>42,26</u>	<u>44,45</u>	<u>45,48</u>	<u>46,46</u>	<u>47,37</u>	<u>48,24</u>	<u>49,83</u>	<u>51,32</u>	<u>53,03</u>	<u>54,66</u>	<u>56,20</u>	<u>57,50</u>

TYPE - 60 Hz	P2	Motor Size	Q (m³/h - l/min)																		
			0	108	120	132	138	144	150	156	168	180	195	210	225	240	255	270	300	330	360
			0	1800	2000	2200	2300	2400	2500	2600	2800	3000	3250	3500	3750	4000	4250	4500	5000	5500	6000
kW		H (m) pump input power (kW)																			
100-200D	30	200L	41,9	41,2	40,8	40,0	39,7	39,3	38,8	38,4	37,3	36,2	34,7	33,2	31,8	30,2	28,4	26,7	22,7		
			<u>21,10</u>	<u>24,40</u>	<u>24,83</u>	<u>25,26</u>	<u>25,50</u>	<u>25,76</u>	<u>26,02</u>	<u>26,27</u>	<u>26,69</u>	<u>26,97</u>	<u>27,28</u>	<u>27,68</u>	<u>28,13</u>	<u>28,64</u>	<u>29,19</u>	<u>29,69</u>	<u>30,42</u>		
100-200C	37	200L	49,8	49,5	49,3	48,6	48,2	47,7	47,2	46,8	45,9	44,9	43,3	41,7	40,1	38,7	37,2	35,6	31,6	26,4	
			<u>23,68</u>	<u>28,27</u>	<u>29,02</u>	<u>29,77</u>	<u>30,14</u>	<u>30,48</u>	<u>30,81</u>	<u>31,12</u>	<u>31,70</u>	<u>32,25</u>	<u>32,85</u>	<u>33,41</u>	<u>34,08</u>	<u>34,81</u>	<u>35,47</u>	<u>36,07</u>	<u>36,90</u>	<u>37,16</u>	
100-200B	45	225M	58,0	58,5	58,3	57,9	57,6	57,3	57,0	56,6	55,8	54,8	53,6	52,2	50,8	49,3	47,8	46,1	41,8	36,9	
			<u>21,69</u>	<u>29,77</u>	<u>30,83</u>	<u>31,89</u>	<u>32,42</u>	<u>32,96</u>	<u>33,51</u>	<u>34,07</u>	<u>35,19</u>	<u>36,32</u>	<u>37,73</u>	<u>39,12</u>	<u>40,37</u>	<u>41,51</u>	<u>42,42</u>	<u>43,16</u>	<u>44,26</u>	<u>45,12</u>	
100-200A	55	250M	64,4	64,8	64,6	64,3	64,0	63,7	63,4	63,1	62,3	61,4	60,2	58,9	57,5	56,1	54,7	53,2	49,3	44,5	39,4
			<u>24,80</u>	<u>34,31</u>	<u>35,51</u>	<u>36,72</u>	<u>37,32</u>	<u>37,94</u>	<u>38,56</u>	<u>39,16</u>	<u>40,45</u>	<u>41,65</u>	<u>43,02</u>	<u>44,31</u>	<u>45,63</u>	<u>46,97</u>	<u>48,14</u>	<u>49,15</u>	<u>50,77</u>	<u>52,16</u>	<u>52,86</u>
100-250C	75	280S	79,9		81,0	80,7	80,6	80,4	80,2	79,9	79,4	78,7	77,7	76,5	74,9	73,1	70,9	68,6	64,1		
			<u>25,58</u>		<u>43,12</u>	<u>44,90</u>	<u>45,79</u>	<u>46,68</u>	<u>47,57</u>	<u>48,46</u>	<u>50,21</u>	<u>51,90</u>	<u>53,93</u>	<u>55,86</u>	<u>57,68</u>	<u>59,39</u>	<u>60,96</u>	<u>62,44</u>	<u>65,30</u>		
100-250B	75	280S	90,0		89,9	89,6	89,4	89,2	89,0	88,8	88,2	87,6	86,8	85,9	84,7	83,3	81,0	78,4	73,2	70,9	
			<u>29,82</u>		<u>49,11</u>	<u>51,23</u>	<u>52,27</u>	<u>53,30</u>	<u>54,32</u>	<u>55,34</u>	<u>57,27</u>	<u>58,98</u>	<u>60,82</u>	<u>62,59</u>	<u>64,38</u>	<u>66,22</u>	<u>68,39</u>	<u>70,55</u>	<u>73,87</u>	<u>77,92</u>	
100-250A	90	280M	100,5		100,7	100,3	100,1	99,8	99,5	99,2	98,4	97,6	96,4	95,0	93,2	91,2	89,3	87,1	81,8	78,7	74,0
			<u>32,74</u>		<u>54,04</u>	<u>56,39</u>	<u>57,55</u>	<u>58,71</u>	<u>59,90</u>	<u>61,08</u>	<u>63,34</u>	<u>65,30</u>	<u>67,40</u>	<u>69,46</u>	<u>71,65</u>	<u>73,82</u>	<u>75,81</u>	<u>77,67</u>	<u>81,17</u>	<u>85,71</u>	<u>88,00</u>



4CA-4CAX

Centrifugal Flanged EN 733

TYPE - 60 Hz	P2	Motor Size	Q (m³/h - l/min)														
			0	1,5	3	4,5	6	7,5	9	10,5	12	15	18	21			
			0	25	50	75	100	125	150	175	200	250	300	350			
			H (m) pump input power (kW)														
32-160C	0,37	71B	5,9 <i>0,15</i>	5,9 <i>0,18</i>	5,8 <i>0,20</i>	5,5 <i>0,22</i>	5,3 <i>0,24</i>	4,8 <i>0,26</i>	4,3 <i>0,28</i>	3,5 <i>0,28</i>	2,6 <i>0,29</i>						
32-160B	0,37	71B	7,2 <i>0,18</i>	7,2 <i>0,21</i>	7,1 <i>0,24</i>	6,7 <i>0,27</i>	6,4 <i>0,29</i>	5,9 <i>0,31</i>	5,3 <i>0,33</i>	4,6 <i>0,34</i>	3,6 <i>0,36</i>						
32-160A	0,55	80A	8,8 <i>0,22</i>	8,8 <i>0,26</i>	8,7 <i>0,29</i>	8,5 <i>0,31</i>	8,2 <i>0,35</i>	7,9 <i>0,37</i>	7,4 <i>0,39</i>	6,9 <i>0,41</i>	6,1 <i>0,43</i>	4,0 <i>0,45</i>					
32-200C	0,75	80B	11,0 <i>0,26</i>		10,8 <i>0,39</i>	10,6 <i>0,43</i>	10,2 <i>0,47</i>	9,9 <i>0,51</i>	9,4 <i>0,54</i>	8,9 <i>0,57</i>	8,4 <i>0,59</i>	6,7 <i>0,66</i>	4,2 <i>0,71</i>				
32-200B	1,1	90S	13,0 <i>0,38</i>		12,7 <i>0,47</i>	12,5 <i>0,51</i>	12,2 <i>0,56</i>	11,7 <i>0,61</i>	11,2 <i>0,66</i>	10,6 <i>0,70</i>	10,1 <i>0,74</i>	8,7 <i>0,78</i>	6,3 <i>0,81</i>				
32-200A	1,1	90S	15,9 <i>0,44</i>		15,7 <i>0,53</i>	15,5 <i>0,57</i>	15,3 <i>0,66</i>	15,0 <i>0,71</i>	14,5 <i>0,77</i>	13,8 <i>0,82</i>	13,2 <i>0,88</i>	11,7 <i>0,98</i>	9,5 <i>1,04</i>	6,8 <i>1,10</i>			
32-250C	1,5	90L	17,5 <i>0,55</i>		17,2 <i>0,75</i>	16,9 <i>0,79</i>	16,6 <i>0,85</i>	16,2 <i>0,90</i>	15,7 <i>0,95</i>	15,1 <i>1,00</i>	14,4 <i>1,04</i>	12,5 <i>1,09</i>	10,0 <i>1,18</i>	6,5 <i>1,21</i>			
32-250B	1,5	90L	20,3 <i>0,75</i>		20,0 <i>0,87</i>	19,7 <i>0,93</i>	19,4 <i>1,00</i>	19,0 <i>1,06</i>	18,4 <i>1,14</i>	17,8 <i>1,19</i>	17,0 <i>1,24</i>	15,3 <i>1,33</i>	12,6 <i>1,39</i>	8,3 <i>1,42</i>			
32-250A	2,2	100L	22,6 <i>0,80</i>		22,2 <i>0,95</i>	21,9 <i>1,03</i>	21,6 <i>1,10</i>	21,3 <i>1,18</i>	20,7 <i>1,24</i>	20,0 <i>1,30</i>	18,9 <i>1,36</i>	17,2 <i>1,46</i>	14,8 <i>1,52</i>	9,1 <i>1,55</i>			

TYPE - 60 Hz	P2	Motor Size	Q (m³/h - l/min)														
			0	4,5	6	7,5	9	10,5	12	15	18	21	24	27	30	33	
			0	75	100	125	150	175	200	250	300	350	400	450	500	550	
			H (m) pump input power (kW)														
40-125C	0,37	71B	4,2 <i>0,15</i>	4,4 <i>0,18</i>	4,3 <i>0,19</i>	4,2 <i>0,21</i>	4,1 <i>0,23</i>	4,0 <i>0,23</i>	3,8 <i>0,25</i>	3,4 <i>0,26</i>	2,8 <i>0,27</i>	2,0 <i>0,29</i>					
40-125B	0,37	71B	5,4 <i>0,19</i>	5,5 <i>0,22</i>	5,5 <i>0,25</i>	5,4 <i>0,26</i>	5,3 <i>0,28</i>	5,2 <i>0,29</i>	5,0 <i>0,31</i>	4,6 <i>0,34</i>	4,0 <i>0,35</i>	3,3 <i>0,37</i>					
40-125A	0,55	80A	6,2 <i>0,23</i>	6,3 <i>0,28</i>	6,3 <i>0,30</i>	6,2 <i>0,32</i>	6,1 <i>0,34</i>	6,0 <i>0,36</i>	5,8 <i>0,38</i>	5,4 <i>0,40</i>	4,9 <i>0,43</i>	4,2 <i>0,44</i>	3,4 <i>0,46</i>				
40-160B	0,55	80A	7,4 <i>0,21</i>	7,5 <i>0,29</i>	7,6 <i>0,34</i>	7,4 <i>0,37</i>	7,2 <i>0,40</i>	7,0 <i>0,42</i>	6,8 <i>0,43</i>	6,1 <i>0,45</i>	4,9 <i>0,47</i>	3,7 <i>0,48</i>	2,5 <i>0,47</i>				
40-160A	0,75	80B	8,8 <i>0,23</i>	8,9 <i>0,34</i>	9,0 <i>0,38</i>	8,9 <i>0,41</i>	8,7 <i>0,45</i>	8,5 <i>0,47</i>	8,3 <i>0,49</i>	7,5 <i>0,53</i>	6,6 <i>0,57</i>	5,6 <i>0,59</i>	4,5 <i>0,60</i>				
40-160AP	0,75 1,10	80B 90S	11,1 <i>0,32</i>	11,1 <i>0,47</i>	11,3 <i>0,52</i>	11,3 <i>0,56</i>	11,1 <i>0,60</i>	10,9 <i>0,64</i>	10,6 <i>0,67</i>	10,0 <i>0,72</i>	9,0 <i>0,77</i>	8,0 <i>0,81</i>	6,8 <i>0,84</i>				
40-200B	1,1	90S	11,3 <i>0,36</i>		11,4 <i>0,52</i>	11,3 <i>0,56</i>	11,1 <i>0,60</i>	10,8 <i>0,64</i>	10,5 <i>0,68</i>	9,6 <i>0,75</i>	8,5 <i>0,78</i>	6,9 <i>0,81</i>	4,7 <i>0,84</i>				
40-200A	1,1	90S	13,8 <i>0,37</i>		13,9 <i>0,64</i>	13,8 <i>0,72</i>	13,6 <i>0,74</i>	13,4 <i>0,79</i>	13,2 <i>0,82</i>	12,3 <i>0,91</i>	11,3 <i>0,99</i>	10,0 <i>1,06</i>	8,3 <i>1,13</i>				
40-200AP	1,1 1,5	90S 90L	14,8 <i>0,41</i>		14,9 <i>0,69</i>	14,8 <i>0,79</i>	14,6 <i>0,81</i>	14,4 <i>0,86</i>	14,2 <i>0,90</i>	13,3 <i>0,99</i>	12,3 <i>1,08</i>	11,0 <i>1,16</i>	9,4 <i>1,23</i>				
40-250C	1,5	90L	15,7 <i>0,61</i>				15,2 <i>0,93</i>	15,0 <i>0,98</i>	14,7 <i>1,04</i>	14,0 <i>1,14</i>	12,8 <i>1,22</i>	11,1 <i>1,32</i>	9,1 <i>1,38</i>	6,6 <i>1,45</i>			
40-250B	2,2	100L	18,3 <i>0,73</i>				18,2 <i>1,13</i>	17,9 <i>1,19</i>	17,7 <i>1,24</i>	17,1 <i>1,39</i>	16,2 <i>1,51</i>	14,9 <i>1,62</i>	12,9 <i>1,73</i>	10,7 <i>1,82</i>	8,3 <i>1,89</i>		
40-250A	2,2	100L	20,9 <i>0,89</i>				20,8 <i>1,32</i>	20,6 <i>1,40</i>	20,4 <i>1,47</i>	19,8 <i>1,62</i>	19,0 <i>1,75</i>	17,9 <i>1,88</i>	16,3 <i>2,00</i>	14,1 <i>2,10</i>	11,5 <i>2,21</i>	8,4 <i>2,31</i>	

TYPE - 60 Hz	P2	Motor Size	Q (m³/h - l/min)																
			0	9	10,5	12	15	18	21	24	27	30	33	36	39	42	45	48	54
			0	150	175	200	250	300	350	400	450	500	550	600	650	700	750	800	900
			H (m) pump input power (kW)																
50-125B	0,55	80A	5,3 <i>0,15</i>	5,5 <i>0,23</i>	5,5 <i>0,25</i>	5,4 <i>0,28</i>	5,3 <i>0,32</i>	5,1 <i>0,38</i>	4,9 <i>0,40</i>	4,7 <i>0,44</i>	4,4 <i>0,45</i>	4,1 <i>0,46</i>	3,6 <i>0,47</i>	3,1 <i>0,47</i>	2,6 <i>0,48</i>	2,1 <i>0,49</i>			
50-125A	0,75	80B	6,2 <i>0,23</i>	6,4 <i>0,38</i>	6,4 <i>0,39</i>	6,3 <i>0,41</i>	6,3 <i>0,44</i>	6,1 <i>0,48</i>	6,0 <i>0,51</i>	5,8 <i>0,55</i>	5,5 <i>0,59</i>	5,2 <i>0,62</i>	4,8 <i>0,63</i>	4,4 <i>0,64</i>	3,9 <i>0,64</i>	3,4 <i>0,64</i>	2,9 <i>0,63</i>		
50-160B	0,75	80B	7,9 <i>0,23</i>	8 <i>0,43</i>	7,9 <i>0,45</i>	7,8 <i>0,47</i>	7,7 <i>0,51</i>	7,3 <i>0,56</i>	6,9 <i>0,60</i>	6,4 <i>0,63</i>	5,9 <i>0,65</i>	5,3 <i>0,66</i>	4,7 <i>0,67</i>	4 <i>0,68</i>	3,2 <i>0,68</i>	2,3 <i>0,67</i>			
50-160A	1,1	90S	9,4 <i>0,34</i>	9,4 <i>0,55</i>	9,4 <i>0,57</i>	9,3 <i>0,59</i>	9,2 <i>0,65</i>	9 <i>0,72</i>	8,7 <i>0,77</i>	8,3 <i>0,80</i>	7,8 <i>0,82</i>	7,2 <i>0,84</i>	6,7 <i>0,86</i>	6 <i>0,87</i>	5,4 <i>0,88</i>	4,7 <i>0,88</i>	3,9 <i>0,89</i>	3,1 <i>0,88</i>	
50-200C	1,1	90S	12,0 <i>0,39</i>	12 <i>0,63</i>	11,8 <i>0,68</i>	11,7 <i>0,72</i>	11,2 <i>0,79</i>	10,7 <i>0,83</i>	10 <i>0,86</i>	9,3 <i>0,89</i>	8,2 <i>0,91</i>	7,2 <i>0,93</i>	6 <i>0,94</i>	4,6 <i>0,94</i>	3,2 <i>0,95</i>				
50-200B	1,5	90L	13,1 <i>0,48</i>		13,1 <i>0,77</i>	13,1 <i>0,83</i>	12,7 <i>0,92</i>	12,2 <i>1,02</i>	11,6 <i>1,09</i>	10,9 <i>1,14</i>	10,0 <i>1,18</i>	9,2 <i>1,22</i>	8,2 <i>1,24</i>	7,0 <i>1,27</i>	5,7 <i>1,27</i>	4,2 <i>1,27</i>			
50-200A	1,5	90L	14,8 <i>0,54</i>		14,7 <i>0,87</i>	14,5 <i>0,92</i>	14,4 <i>1,03</i>	13,9 <i>1,14</i>	13,4 <i>1,22</i>	12,7 <i>1,28</i>	11,9 <i>1,32</i>	11,0 <i>1,36</i>	10,0 <i>1,40</i>	8,9 <i>1,43</i>	7,6 <i>1,45</i>	6,3 <i>1,47</i>	4,6 <i>1,48</i>		
50-250C	2,2	100L	17,9 <i>0,58</i>		17,7 <i>1,24</i>	17,4 <i>1,32</i>	16,9 <i>1,47</i>	16,4 <i>1,59</i>	15,8 <i>1,71</i>	14,9 <i>1,80</i>	14,2 <i>1,89</i>	13,4 <i>1,97</i>	12,4 <i>2,04</i>	11,0 <i>2,10</i>	9,5 <i>2,16</i>	7,5 <i>2,22</i>			
50-250B	3	100L	19,9 <i>0,79</i>				19,6 <i>1,58</i>	19,1 <i>1,72</i>	18,8 <i>1,85</i>	18,2 <i>1,97</i>	17,5 <i>2,07</i>	16,7 <i>2,19</i>	15,7 <i>2,28</i>	14,6 <i>2,37</i>	13,6 <i>2,45</i>	12,0 <i>2,52</i>	10,4 <i>2,58</i>	8,2 <i>2,64</i>	
50-250A	4	112M	23,0 <i>0,90</i>				22,7 <i>1,84</i>	22,5 <i>2,07</i>	22,2 <i>2,21</i>	21,8 <i>2,42</i>	21,1 <i>2,60</i>	20,4 <i>2,78</i>	19,5 <i>2,95</i>	18,7 <i>3,12</i>	17,7 <i>3,28</i>	16,6 <i>3,43</i>	15,2 <i>3,53</i>	13,4 <i>3,62</i>	8,4 <i>3,74</i>



TYPE - 60 Hz	P2	Motor Size	Q (m³/h - l/min)																			
			0	18	21	24	27	30	33	36	39	42	45	48	54	60	66	72	78	84	90	96
	kW	0	300	350	400	450	500	550	600	650	700	750	800	900	1000	1100	1200	1300	1400	1500	1600	
			H (m)																			
			pump input power (kW)																			
50-315C No EN 733	5,5	132M	24,4 1,64	24,7 2,58	24,7 2,77	24,6 2,96	24,5 3,15	24,3 3,33	24,0 3,50	23,7 3,66	23,4 3,82	23,1 3,96	22,8 4,11	22,5 4,24	21,9 4,51	21,1 4,77	20,2 5,01	19,2 5,23	18,1 5,43	16,8 5,62		
50-315B No EN 733	7,5	132M	31,3 2,35	31,4 3,54	31,4 3,78	31,3 4,01	31,3 4,24	31,2 4,47	30,9 4,68	30,6 4,89	30,3 5,08	29,9 5,27	29,5 5,46	29,1 5,64	28,2 5,99	27,3 6,32	26,5 6,61	25,5 6,89	24,4 7,14	23,1 7,37	21,6 7,58	
50-315A No EN 733	11	160M	37,5 3,06	37,2 4,39	37,2 4,65	37,1 4,92	37,0 5,18	36,9 5,45	36,7 5,72	36,5 5,97	36,3 6,22	36,0 6,45	35,6 6,68	35,2 6,90	34,3 7,31	33,3 7,69	32,1 8,04	30,9 8,37	29,7 8,69	28,4 8,96	26,9 9,18	25,1 9,37

TYPE - 60 Hz	P2	Motor Size	Q (m³/h - l/min)																			
			0	18	21	24	27	30	33	36	39	42	45	48	54	60	66	72	78	84	90	
	kW	0	300	350	400	450	500	550	600	650	700	750	800	900	1000	1100	1200	1300	1400	1500		
			H (m)																			
			pump input power (kW)																			
65-125B	0,75	80M	4,9 0,31	5,1 0,48	5,1 0,50	5,0 0,53	5,0 0,55	4,9 0,57	4,7 0,60	4,6 0,63	4,5 0,64	4,3 0,66	4,0 0,67	3,8 0,68	3,3 0,69	2,8 0,68						
65-125A	1,1	90S	6,1 0,40	6,3 0,60	6,2 0,63	6,1 0,66	6,1 0,69	6,0 0,73	5,9 0,76	5,8 0,79	5,7 0,80	5,5 0,82	5,3 0,83	5,0 0,85	4,7 0,86	4,3 0,88	3,7 0,88	3,0 0,88				
65-160C	1,5	90L	7,3 0,44			7,6 0,80	7,5 0,85	7,3 0,89	7,2 0,93	7,0 0,96	6,8 0,99	6,7 1,01	6,4 1,02	6,2 1,04	5,7 1,07	5,1 1,12	4,4 1,13	3,6 1,13	2,9 1,13			
65-160B	1,5	90L	8,4 0,47			8,6 0,86	8,4 0,90	8,3 0,95	8,2 1,01	8,0 1,06	7,8 1,11	7,6 1,14	7,4 1,17	7,2 1,19	6,5 1,25	5,9 1,28	5,2 1,31	4,4 1,33	3,6 1,34			
65-160A	2,2	100L	9,8 0,66			9,9 1,06	9,9 1,14	9,8 1,20	9,6 1,25	9,5 1,30	9,3 1,34	9,1 1,39	8,9 1,42	8,7 1,46	8,2 1,52	7,6 1,58	6,8 1,63	6,1 1,67	5,3 1,72	4,6 1,72		
65-200C	2,2	100L	11,0 0,48				11,6 1,26	11,5 1,35	11,4 1,44	11,3 1,53	11,2 1,60	10,9 1,66	10,5 1,72	10,3 1,79	9,7 1,90	9,1 1,96	8,3 2,01	7,4 2,06	6,5 2,11	5,0 2,14		
65-200B	3	100L	12,3 0,69				13,1 1,45	13,0 1,51	12,8 1,61	12,7 1,70	12,5 1,77	12,3 1,88	12,1 1,95	11,9 2,01	11,3 2,11	10,6 2,21	10,0 2,29	9,0 2,36	8,0 2,42	7,0 2,48		
65-200A	3	100L	14,0 1,12				14,8 1,74	14,7 1,82	14,6 1,92	14,5 2,02	14,2 2,10	14,0 2,18	13,9 2,26	13,7 2,34	13,3 2,48	12,7 2,59	12,0 2,70	11,3 2,81	10,3 2,91	9,3 3,00		
65-250B	4 5,5	112M 132S	20,6 1,42				21,0 2,87	20,8 2,98	20,4 3,18	20,1 3,38	19,8 3,50	19,3 3,61	18,8 3,70	18,4 3,78	17,3 3,87	16,0 3,97	14,5 4,07	12,9 4,17	11,2 4,19	8,7 4,21		
65-250A	5,5	132S	22,8 1,58				22,9 3,41	22,5 3,56	22,1 3,70	21,7 3,79	21,4 3,88	20,9 4,00	20,4 4,11	19,2 4,31	18,0 4,44	16,9 4,58	15,4 4,71	13,6 4,75	11,5 4,79	8,8 4,80		

TYPE - 60 Hz	P2	Motor Size	Q (m³/h - l/min)																							
			0	27	30	33	36	39	42	45	48	54	60	66	72	78	84	90	96	102	108	114	120	126	132	138
	kW	0	450	500	550	600	650	700	750	800	900	1000	1100	1200	1300	1400	1500	1600	1700	1800	1900	2000	2100	2200	2300	
			H (m)																							
			pump input power (kW)																							
65-315CM	7,5	132M	22,2 1,82	23,3 3,30	23,3 3,46	23,2 3,63	23,1 3,79	23,0 3,95	22,9 4,11	22,8 4,27	22,6 4,42	22,1 4,72	21,6 5,02	21,2 5,30	20,7 5,57	20,2 5,84	19,6 6,10	18,9 6,36	18,2 6,60	17,4 6,84	16,5 7,06	15,6 7,27	14,5 7,47	13,5 7,66		
65-315BM	11	160M	27,4 2,47	28,2 4,17	28,2 4,37	28,2 4,58	28,2 4,78	28,1 4,98	28,0 5,17	27,8 5,36	27,6 5,54	27,2 5,91	26,7 6,26	26,2 6,60	25,7 6,93	25,2 7,26	24,6 7,57	24,1 7,88	23,4 8,18	22,7 8,47	21,8 8,76	20,8 9,03	19,8 9,29	18,9 9,54	18,1 9,78	
65-315AM	11	160M	32,9 3,20	33,4 5,15	33,4 5,38	33,4 5,60	33,3 5,83	33,3 6,04	33,2 6,25	33,1 6,46	32,9 6,67	32,3 7,12	31,8 7,55	31,2 7,97	30,6 8,36	30,0 8,75	29,4 9,10	28,7 9,44	28,1 9,77	27,3 10,10	26,4 10,44	25,3 10,78	24,2 11,11	23,2 11,41	22,1 11,68	20,9 11,94

TYPE - 60 Hz	P2	Motor Size	Q (m³/h - l/min)																					
			0	24	27	30	33	36	42	48	60	72	84	96	102	108	120	132	144					
	kW	0	400	450	500	550	600	700	800	1000	1200	1400	1600	1700	1800	2000	2200	2400						
			H (m)																					
			pump input power (kW)																					
80-160E	1,1	90S	5,5 0,35	5,7 0,71	5,7 0,74	5,7 0,74	5,6 0,78	5,4 0,81	5,1 0,88	4,9 0,90	4,2 0,97	3,8 1,02	2,8 1,02	2,2 1,00										
80-160D	1,5	90L	6,3 0,61		6,8 0,89	6,7 0,91	6,6 0,95	6,5 0,98	6,3 1,04	6,1 1,10	5,5 1,19	4,8 1,25	4 1,28	3,1 1,30	2,6 1,29									
80-160C	1,5	90L	7,0 0,67			7,4 1,04	7,3 1,08	7,3 1,12	7,1 1,18	6,8 1,25	6,4 1,35	5,7 1,42	4,9 1,47	4 1,48	3,5 1,48	3,1 1,48								
80-160B	2,2	100L	8,5 0,62				8,9 1,29	8,9 1,35	8,7 1,43	8,5 1,51	8,0 1,72	7,5 1,87	6,8 1,95	5,7 2,01	5,2 2,02	4,7 2,04	3,5 2,04	3,1 2,04						
80-160A	3	100L	9,3 1,09					9,8 1,60	9,7 1,71	9,5 1,81	9,1 2,01	8,6 2,14	7,9 2,27	7,1 2,34	6,6 2,37	6,2 2,39	5,0 2,42	3,8 2,43						
80-200B	4	112M	12,2 1,35						13,1 2,43	12,9 2,59	12,4 2,91	11,9 3,18	11,4 3,40	10,7 3,55	10,2 3,62	9,6 3,69	8,2 3,79	6,8 3,81						
80-200A	5,5	132S	13,7 1,51						14,9 2,81	14,8 2,99	14,3 3,33	13,8 3,62	13,2 3,85	12,5 4,05	12,0 4,15	11,5 4,23	10,3 4,38	8,9 4,47	7,3 4,51					
80-250B	5,5	132S	19,1 1,76						19,2 3,67	19,1 3,93	18,5 4,49	17,9 4,98	17,2 5,35	16,2 5,63	15,7 5,75	15,1 5,86	13,7 6,05	12,2 6,20						
80-250A	7,5	132M	22,3 2,22						23,0 4,45	22,7 4,74	22,1 5,32	21,4 5,83	20,4 6,22	19,2 6,59	18,6 6,76	18,0 6,91	16,8 7,17	15,3 7,39	13,6 7,55					



4CA-4CAX ~ EN 733

TYPE - 60 Hz	P2	Motor Size	Q (m³/h - l/min)														
			0	42	48	60	72	84	96	102	108	120	132	144	150	156	168
	kW	0	700	800	1000	1200	1400	1600	1700	1800	2000	2200	2400	2500	2600	2800	
			H (m) pump input power (kW)														
80-315B	11	160M	27,7 2,99	28,3 5,48	28,2 5,88	27,9 6,67	27,2 7,42	26,4 8,09	25,4 8,67	24,9 8,95	24,4 9,21	23,3 9,74	21,9 10,28	20,5 10,66	19,9 10,85		
80-315A	15	160L	34,5 4,29	35,0 7,30	34,9 7,78	34,6 8,75	34,0 9,66	33,3 10,53	32,4 11,37	31,9 11,77	31,3 12,17	30,1 12,91	28,8 13,50	27,3 14,05	26,4 14,31	25,5 14,56	23,7 15,04

TYPE - 60 Hz	P2	Motor Size	Q (m³/h - l/min)																
			0	48	60	72	84	96	102	108	120	132	144	150	156	168	180	192	204
	kW	0	800	1000	1200	1400	1600	1700	1800	2000	2200	2400	2500	2600	2800	3000	3200	3400	
			H (m) pump input power (kW)																
100-200D	4	112M	10,7 2,82	10,4 3,09	10,2 3,29	9,8 3,39	9,4 3,44	8,7 3,46	8,4 3,48	8,1 3,49	7,5 3,55	6,9 3,60	6,1 3,69	5,7 3,71	5,3 3,72	4,4 3,70			
100-200C	5,5	132S	12,5 3,03	12,5 3,54	12,3 3,88	12,0 4,02	11,5 4,13	10,9 4,18	10,6 4,21	10,3 4,24	9,7 4,35	9,1 4,45	8,3 4,52	8,0 4,54	7,4 4,57	6,5 4,58			
100-200B	5,5	132S	14,3 2,81	14,3 3,57	14,2 3,82	13,9 4,07	13,5 4,32	13,0 4,56	12,7 4,66	12,4 4,76	11,9 4,94	11,2 5,07	10,5 5,16	10,0 5,20	9,6 5,23	8,6 5,26	7,6 5,27		
100-200A	7,5	132M	15,9 3,12	16,0 4,06	15,9 4,35	15,7 4,63	15,3 4,93	14,9 5,25	14,6 5,40	14,4 5,54	13,9 5,80	13,3 6,00	12,7 6,15	12,3 6,20	11,9 6,26	10,9 6,36	9,9 6,43	8,8 6,47	
100-250E	7,5	132M	18,0 3,08		18,1 4,89	18,0 5,29	17,7 5,67	17,3 6,02	17,1 6,19	16,8 6,37	16,0 6,70	15,1 6,99	14,2 7,24	13,7 7,35	13,1 7,45	12,0 7,61	10,6 7,73		
100-250D	7,5 11	132M 160M	21,2 3,40		21,1 5,67	20,8 6,13	20,5 6,55	20,1 6,92	19,8 7,10	19,5 7,27	18,8 7,60	17,9 7,94	16,8 8,25	16,3 8,38	15,7 8,49	14,5 8,69	13,2 8,85	11,8 9,00	
100-250A	11	160M	24,3 3,97		23,9 6,41	23,6 6,94	23,2 7,44	22,7 7,90	22,4 8,12	22,1 8,32	21,4 8,70	20,6 9,06	19,5 9,40	19,0 9,55	18,3 9,69	17,0 9,92	15,6 10,11	14,2 10,27	12,7 10,43

TYPE - 60 Hz	P2	Motor Size	Q (m³/h - l/min)															
			0	72	84	96	102	108	120	132	144	150	156	168	180	192	204	216
	kW	0	1200	1400	1600	1700	1800	2000	2200	2400	2500	2600	2800	3000	3200	3400	3600	
			H (m) pump input power (kW)															
100-315B	15	160L	31,1 5,27	31,5 9,67	30,7 10,42	29,8 11,09	29,3 11,41	28,9 11,71	27,9 12,27	26,9 12,79	26,0 13,27	25,5 13,50	25,0 13,72	23,8 14,12	22,4 14,50	20,7 14,84	19,0 15,14	17,3 15,39
100-315A	18,5	180M	36,3 6,29	36,8 11,39	36,0 12,31	35,0 13,12	34,5 13,49	34,0 13,84	33,1 14,51	32,2 15,12	31,2 15,69	30,7 15,97	30,1 16,23	29,0 16,76	27,7 17,26	26,2 17,71	24,5 18,11	22,7 18,46

TYPE - 60 Hz	P2	Motor Size	Q (m³/h - l/min)																	
			0	84	96	102	108	120	132	144	150	156	168	180	192	204	216	228	240	252
	kW	0	1400	1600	1700	1800	2000	2200	2400	2500	2600	2800	3000	3200	3400	3600	3800	4000	4200	
			H (m) pump input power (kW)																	
100-400C	22	180L	41,8 7,59	41,2 14,71	40,2 15,77	39,6 16,29	39,1 16,77	38,0 17,58	36,9 18,31	35,8 19,06	35,2 19,42	34,6 19,78	33,4 20,48	32,2 21,14	30,7 21,72	29,1 22,24	27,3 22,71	25,5 23,18		
100-400B	30	200L	50,0 9,48	49,1 18,22	48,4 19,48	47,9 20,10	47,5 20,70	46,4 21,84	45,2 22,92	44,0 23,89	43,3 24,35	42,2 24,80	41,5 25,66	40,3 26,49	38,9 27,38	37,3 28,21	35,6 28,88	33,8 29,47	31,8 30,00	
100-400A	37	225S	58,6 11,70	57,5 21,90	56,7 23,46	56,3 24,23	55,8 24,96	54,8 26,30	53,6 27,56	52,4 28,74	51,7 29,31	51,1 29,87	49,7 31,02	48,3 32,13	47,2 33,18	46,1 34,16	44,6 35,04	42,6 35,79	40,5 36,47	38,5 37,10

TYPE - 60 Hz	P2	Motor Size	Q (m³/h - l/min)																
			0	102	108	120	132	144	150	156	168	180	192	204	216	228	240	252	276
	kW	0	1700	1800	2000	2200	2400	2500	2600	2800	3000	3200	3400	3600	3800	4000	4200	4600	
			H (m) pump input power (kW)																
125-250B	11	160M	21,0 7,40	21,9 9,38	21,6 9,50	20,9 9,70	20,1 9,88	19,4 10,09	19,0 10,20	18,5 10,31	17,9 10,52	17,1 10,72	16,2 10,89	15,1 11,03	13,9 11,12	12,6 11,16	11,5 11,15	10,2 11,08	
125-250A	15	160L	25,0 8,48	26,4 11,32	26,1 11,53	25,6 11,92	25,0 12,25	24,3 12,57	24,0 12,75	23,8 12,96	23,2 13,41	22,5 13,79	21,7 14,13	20,8 14,41	19,8 14,64	18,7 14,84	17,5 15,01	16,3 15,13	13,7 15,22



TYPE - 60 Hz	P2	Motor Size	Q (m³/h - l/min)																			
			0	120	132	144	150	156	168	180	192	204	216	228	240	252	276	348	372	396		
			0	2000	2200	2400	2500	2600	2800	3000	3200	3400	3600	3800	4000	4200	4600	5800	6200	6600		
kW	H (m)																					
	pump input power (kW)																					
125-315C	22	180L	22,7 <i>7,94</i>	24,6 <i>13,06</i>	24,4 <i>13,61</i>	24,1 <i>14,19</i>	24,0 <i>14,49</i>	23,8 <i>14,79</i>	23,5 <i>15,40</i>	23,2 <i>16,00</i>	22,8 <i>16,61</i>	22,5 <i>17,20</i>	22,2 <i>17,76</i>	21,9 <i>18,30</i>	21,4 <i>18,80</i>	20,8 <i>19,26</i>	19,1 <i>20,06</i>	12,3 <i>21,35</i>				
125-315B	30	200L	30,1 <i>10,95</i>	31,9 <i>17,09</i>	31,9 <i>17,84</i>	31,7 <i>18,58</i>	31,6 <i>18,96</i>	31,5 <i>19,35</i>	31,3 <i>20,17</i>	31,0 <i>21,04</i>	30,6 <i>21,89</i>	30,3 <i>22,64</i>	30,0 <i>23,31</i>	29,7 <i>23,94</i>	29,3 <i>24,60</i>	28,9 <i>25,31</i>	27,8 <i>26,68</i>	22,2 <i>29,64</i>	20,3 <i>30,62</i>			
125-315A	37	225S	34,7 <i>12,41</i>	37,1 <i>20,09</i>	37,2 <i>21,03</i>	37,1 <i>22,01</i>	37,0 <i>22,50</i>	36,9 <i>22,99</i>	36,7 <i>23,95</i>	36,4 <i>24,86</i>	36,1 <i>25,74</i>	35,8 <i>26,59</i>	35,5 <i>27,39</i>	35,1 <i>28,13</i>	34,7 <i>28,85</i>	34,3 <i>29,57</i>	33,3 <i>31,09</i>	28,9 <i>35,18</i>	26,8 <i>36,24</i>			
125-400C	45	225M	46,2 <i>13,91</i>	47,6 <i>24,65</i>	47,5 <i>25,83</i>	47,2 <i>27,03</i>	47,0 <i>27,62</i>	46,9 <i>28,20</i>	46,5 <i>29,31</i>	46,1 <i>30,30</i>	45,7 <i>31,22</i>	45,2 <i>32,17</i>	44,7 <i>33,24</i>	44,2 <i>34,42</i>	43,7 <i>35,62</i>	43,2 <i>36,73</i>	42,4 <i>38,53</i>	36,5 <i>43,95</i>	33,8 <i>45,52</i>			
125-400B	55	250M	53,4 <i>16,79</i>	54,5 <i>28,74</i>	54,3 <i>30,15</i>	54,1 <i>31,55</i>	54,0 <i>32,25</i>	53,9 <i>32,94</i>	53,5 <i>34,30</i>	53,2 <i>35,60</i>	52,7 <i>36,85</i>	52,3 <i>38,07</i>	51,7 <i>39,30</i>	51,2 <i>40,56</i>	50,6 <i>41,82</i>	50,0 <i>43,06</i>	48,8 <i>45,43</i>	44,6 <i>51,75</i>	42,0 <i>53,55</i>	39,1 <i>55,27</i>		
125-400A	75	280S	58,6 <i>18,95</i>	59,5 <i>31,66</i>	59,4 <i>33,20</i>	59,2 <i>34,74</i>	59,1 <i>35,52</i>	59,0 <i>36,29</i>	58,7 <i>37,81</i>	58,3 <i>39,30</i>	57,8 <i>40,77</i>	57,4 <i>42,22</i>	56,8 <i>43,66</i>	56,3 <i>45,09</i>	55,7 <i>46,50</i>	55,1 <i>47,87</i>	53,9 <i>50,49</i>	49,9 <i>57,63</i>	47,2 <i>59,76</i>	45,0 <i>61,83</i>		

TYPE - 60 Hz	P2	Motor Size	Q (m³/h - l/min)																			
			0	144	150	156	168	180	192	204	216	228	240	252	276	348	372	396	444	492	540	564
			0	2400	2500	2600	2800	3000	3200	3400	3600	3800	4000	4200	4600	5800	6200	6600	7400	8200	9000	9400
kW	H (m)																					
	pump input power (kW)																					
150-315D	30	200L	23,9 <i>15,21</i>	27,0 <i>20,50</i>	27,0 <i>20,74</i>	26,9 <i>20,99</i>	26,8 <i>21,50</i>	26,6 <i>22,01</i>	26,4 <i>22,53</i>	26,2 <i>23,04</i>	25,9 <i>23,53</i>	25,6 <i>24,00</i>	25,3 <i>24,44</i>	25,0 <i>24,85</i>	24,3 <i>25,63</i>	21,5 <i>27,81</i>	20,4 <i>28,56</i>	19,2 <i>29,30</i>	16,4 <i>30,78</i>			
150-315C	37	225S	28,4 <i>16,50</i>	31,8 <i>23,70</i>	31,8 <i>24,01</i>	31,8 <i>24,32</i>	31,8 <i>24,94</i>	31,7 <i>25,57</i>	31,5 <i>26,20</i>	31,4 <i>26,82</i>	31,2 <i>27,42</i>	31,0 <i>28,00</i>	30,8 <i>28,55</i>	30,5 <i>29,09</i>	29,9 <i>30,10</i>	27,5 <i>33,00</i>	26,6 <i>34,06</i>	25,7 <i>35,17</i>	23,2 <i>37,00</i>	19,6 <i>38,00</i>		
150-315B	45	225M	32,2 <i>18,32</i>	36,3 <i>26,50</i>	36,3 <i>26,85</i>	36,3 <i>27,21</i>	36,2 <i>27,93</i>	36,1 <i>28,65</i>	36,0 <i>29,37</i>	35,8 <i>30,09</i>	35,6 <i>30,80</i>	35,4 <i>31,50</i>	35,2 <i>32,18</i>	35,0 <i>32,86</i>	34,7 <i>34,19</i>	32,8 <i>38,00</i>	31,8 <i>39,24</i>	30,7 <i>40,48</i>	28,0 <i>42,60</i>	24,5 <i>44,00</i>	20,8 <i>45,50</i>	
150-315A	55	250M	39,4 <i>20,63</i>	41,0 <i>30,00</i>	41,0 <i>30,40</i>	40,9 <i>30,81</i>	40,8 <i>31,62</i>	40,7 <i>32,44</i>	40,5 <i>33,26</i>	40,4 <i>34,08</i>	40,2 <i>34,89</i>	40,0 <i>35,70</i>	39,8 <i>36,50</i>	39,6 <i>37,30</i>	39,2 <i>38,90</i>	37,6 <i>43,50</i>	36,9 <i>44,94</i>	36,0 <i>46,33</i>	34,1 <i>49,00</i>	31,7 <i>51,50</i>	28,0 <i>53,50</i>	26,0 <i>54,50</i>

TYPE - 60 Hz	P2	Motor Size	Q (m³/h - l/min)																			
			0	168	180	192	204	216	228	240	252	276	348	372	396	444	492	540	564	588	612	
			0	2800	3000	3200	3400	3600	3800	4000	4200	4600	5800	6200	6600	7400	8200	9000	9400	9800	10200	
kW	H (m)																					
	pump input power (kW)																					
150-400C	75	280S	45,6 <i>20,78</i>	47,8 <i>35,35</i>	47,7 <i>36,41</i>	47,6 <i>37,46</i>	47,4 <i>38,54</i>	47,2 <i>39,58</i>	47,0 <i>40,43</i>	46,7 <i>41,65</i>	46,5 <i>42,62</i>	45,8 <i>44,48</i>	43,9 <i>50,44</i>	43,1 <i>52,51</i>	42,0 <i>54,34</i>	39,2 <i>57,61</i>	35,8 <i>60,59</i>	31,5 <i>63,18</i>	28,7 <i>64,43</i>			
150-400B	75	280S	52,8 <i>26,57</i>	54,4 <i>41,90</i>	54,2 <i>43,10</i>	53,9 <i>44,29</i>	53,7 <i>45,48</i>	53,5 <i>46,65</i>	53,2 <i>47,81</i>	52,9 <i>48,96</i>	52,6 <i>50,10</i>	51,8 <i>52,35</i>	50,3 <i>58,79</i>	49,8 <i>60,86</i>	48,9 <i>62,94</i>	46,1 <i>66,80</i>	42,9 <i>70,20</i>	39,1 <i>73,30</i>	36,7 <i>74,72</i>	34,3 <i>76,14</i>		
150-400A	90	280M	59,0 <i>29,82</i>	60,3 <i>47,01</i>	60,2 <i>48,30</i>	60,0 <i>49,59</i>	59,8 <i>50,88</i>	59,9 <i>52,18</i>	59,4 <i>53,48</i>	59,1 <i>54,78</i>	58,8 <i>56,10</i>	58,1 <i>58,76</i>	56,4 <i>66,15</i>	56,0 <i>68,45</i>	55,3 <i>70,93</i>	53,3 <i>75,79</i>	50,6 <i>79,82</i>	46,7 <i>83,73</i>	44,5 <i>85,61</i>	42,2 <i>87,41</i>	39,8 <i>89,16</i>	



4CA-4CAX

4CA - 4CAX ~ 1750 rpm

Machines complementing the existing range, not envisaged in the EN 733 standard

TYPE - 60 Hz	P2	Motor Size	Q (m³/h - l/min)							
			0	200	250	400	600	800	850	900
	kW	0	3333	4167	6667	10000	13333	14167	15000	
			H (m) <i>pump input power (kW)</i>							
200-315B	55	250M	33,4 <u>25,04</u>	33,4 <u>36,30</u>	33,2 <u>38,91</u>	32,2 <u>46,32</u>	28,6 <u>52,72</u>	21,7 <u>55,67</u>	19,4 <u>55,62</u>	16,7 <u>55,25</u>
200-315A	75	280S	36,3 <u>27,90</u>	35,9 <u>39,49</u>	35,8 <u>42,13</u>	35,0 <u>50,07</u>	31,8 <u>58,82</u>	24,9 <u>62,36</u>	22,5 <u>62,45</u>	19,8 <u>62,15</u>
200-400C	90	280M	43,0 <u>31,27</u>	44,1 <u>45,90</u>	44,1 <u>50,14</u>	43,6 <u>62,49</u>	39,9 <u>77,58</u>	31,5 <u>89,60</u>		
200-400B	110	315S	49,5 <u>40,00</u>	50,8 <u>54,29</u>	51,0 <u>58,92</u>	50,6 <u>73,89</u>	47,2 <u>91,32</u>	39,5 <u>105,65</u>	36,6 <u>108,43</u>	
200-400A	132	315M	57,2 <u>49,00</u>	58,5 <u>65,01</u>	58,6 <u>70,26</u>	58,2 <u>87,26</u>	55,2 <u>107,05</u>	48,2 <u>124,54</u>	45,6 <u>128,46</u>	44,0 <u>132,15</u>

TYPE - 60 Hz	P2	Motor Size	Q (m³/h - l/min)													
			0	250	400	600	800	850	900	1100	1170	1200	1300	1400	1500	1600
	kW	0	4167	6667	10000	13333	14167	15000	18333	19500	20000	21667	23333	25000	26667	
			H (m) <i>pump input power (kW)</i>													
250-315B	75	280S	33,2 <u>43,46</u>	33,0 <u>54,77</u>	32,7 <u>61,20</u>	31,8 <u>68,72</u>	29,6 <u>74,57</u>	28,6 <u>75,26</u>	27,5 <u>75,64</u>	21,7 <u>74,47</u>	19,0 <u>73,35</u>					
250-315A	90	280M	35,8 <u>46,41</u>	35,0 <u>57,61</u>	34,4 <u>64,50</u>	33,3 <u>73,28</u>	31,3 <u>78,44</u>	30,4 <u>79,01</u>	29,3 <u>79,32</u>	23,0 <u>78,27</u>	20,7 <u>77,03</u>	20,0 <u>76,36</u>				
250-400D	110	315S	38,3 <u>48,00</u>	39,9 <u>61,74</u>	39,9 <u>71,25</u>	39,0 <u>84,15</u>	36,9 <u>95,73</u>	36,1 <u>98,36</u>	35,2 <u>100,80</u>	30,6 <u>108,97</u>	28,6 <u>111,27</u>	27,7 <u>112,17</u>	24,3 <u>114,78</u>			
250-400C	132	315M	44,0 <u>53,83</u>	45,8 <u>71,89</u>	45,9 <u>83,20</u>	44,9 <u>98,11</u>	42,7 <u>112,06</u>	42,0 <u>115,25</u>	41,2 <u>118,20</u>	37,2 <u>128,07</u>	35,4 <u>130,85</u>	34,5 <u>131,93</u>	31,3 <u>135,08</u>	27,4 <u>137,50</u>		
250-400B	160	315L	50,0 <u>64,57</u>	51,7 <u>84,18</u>	51,8 <u>97,49</u>	51,0 <u>115,36</u>	49,0 <u>131,10</u>	48,4 <u>134,76</u>	47,6 <u>138,27</u>	43,9 <u>151,48</u>	42,3 <u>155,58</u>	41,5 <u>157,12</u>	38,5 <u>161,60</u>	34,8 <u>164,88</u>	30,3 <u>167,09</u>	
250-400A	200	315L	55,7 <u>70,94</u>	57,4 <u>91,89</u>	57,5 <u>106,81</u>	56,5 <u>127,19</u>	54,5 <u>145,00</u>	53,8 <u>149,18</u>	53,0 <u>153,24</u>	49,4 <u>168,92</u>	47,9 <u>173,94</u>	47,1 <u>175,86</u>	44,3 <u>181,62</u>	40,8 <u>186,11</u>	36,6 <u>189,07</u>	31,7 <u>190,57</u>



32-160

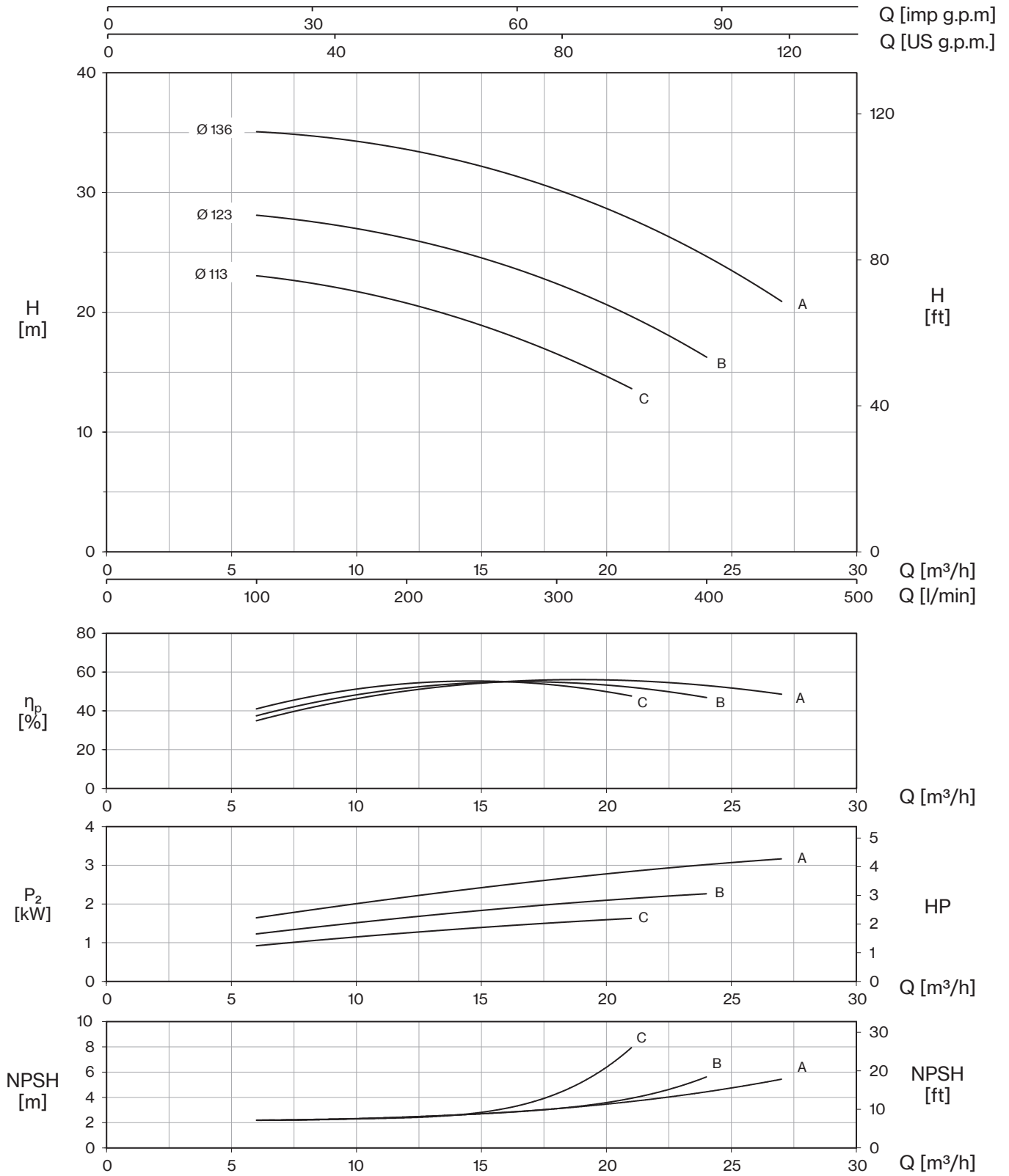

32-200

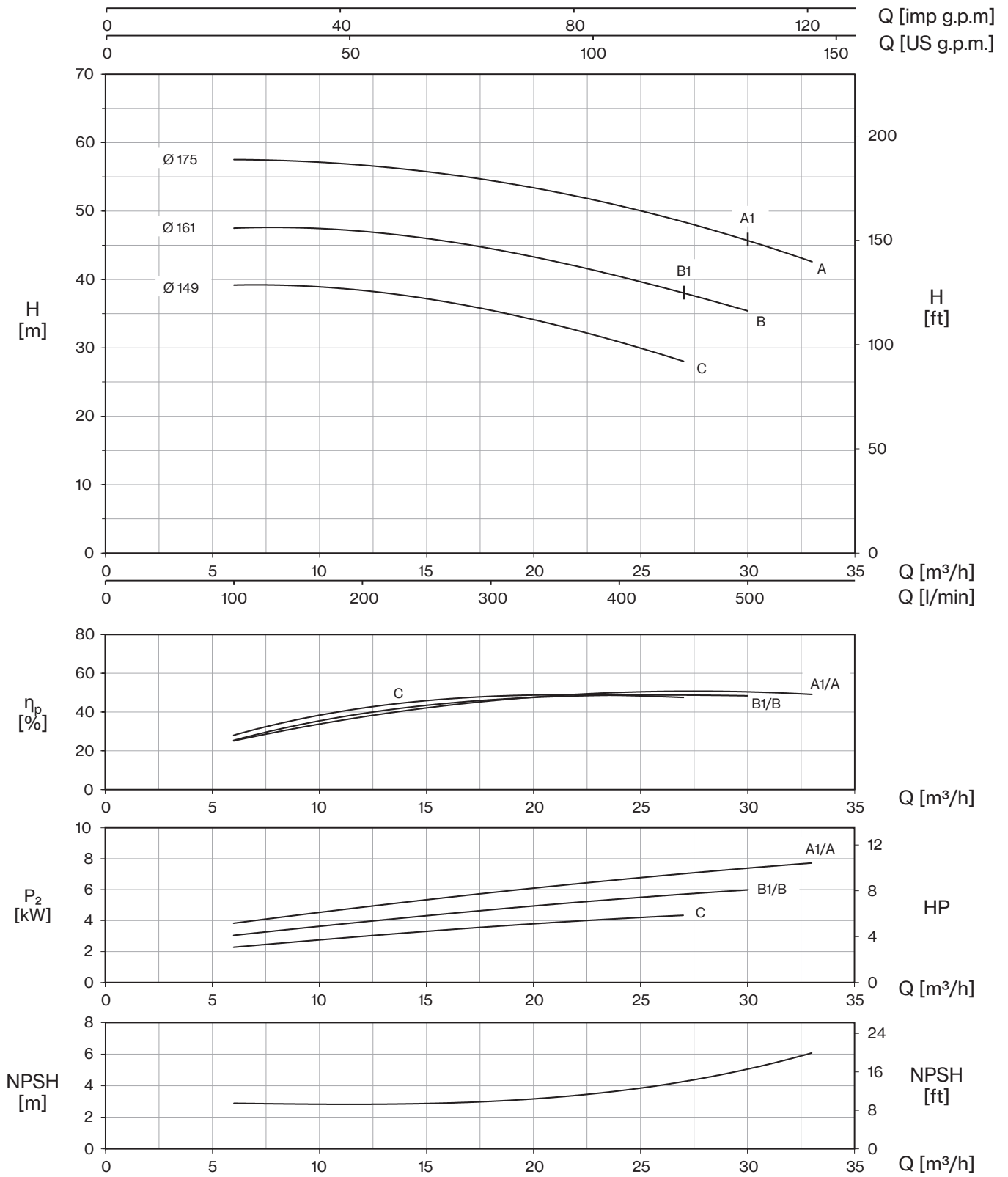

32-250

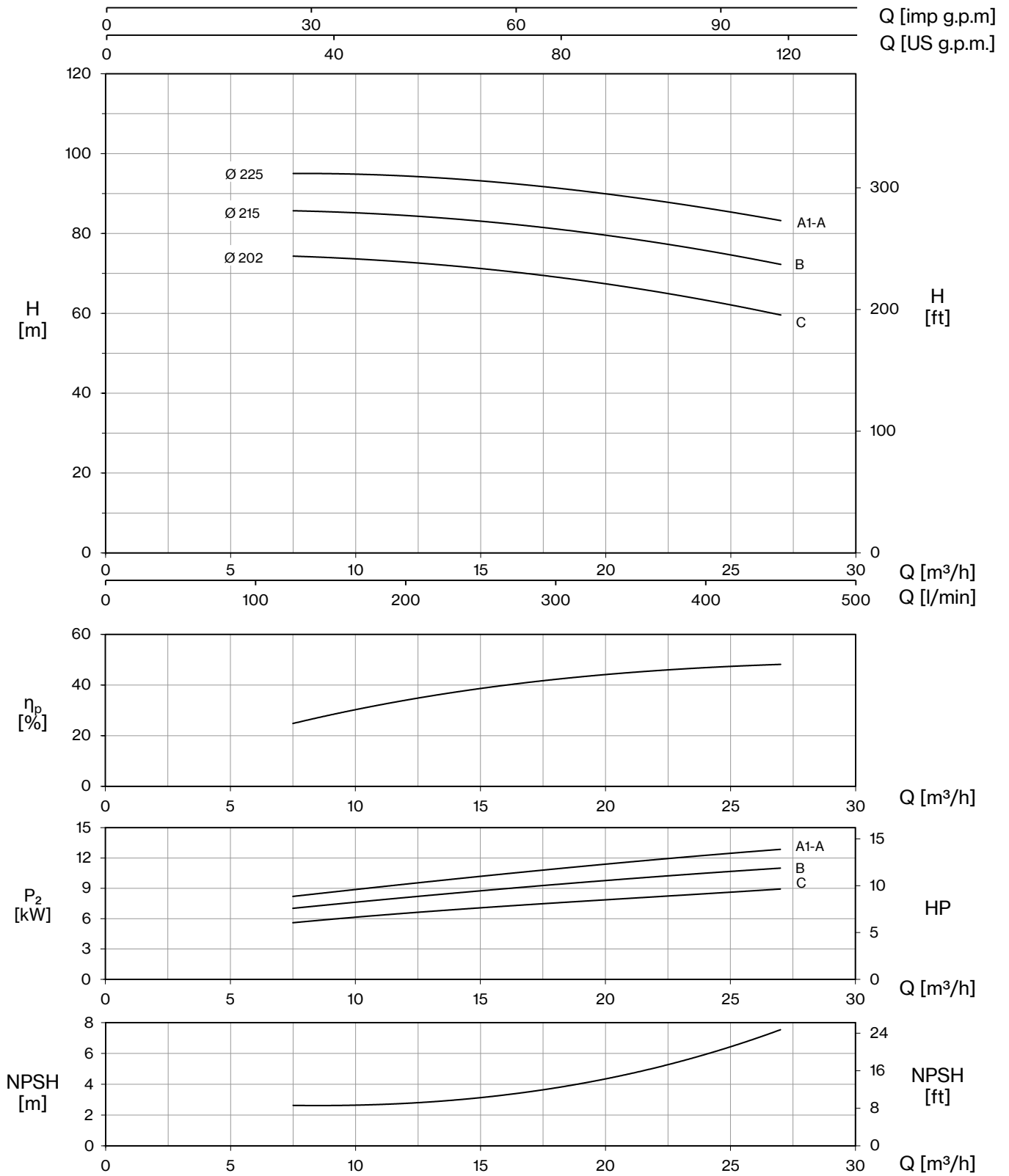

40-125

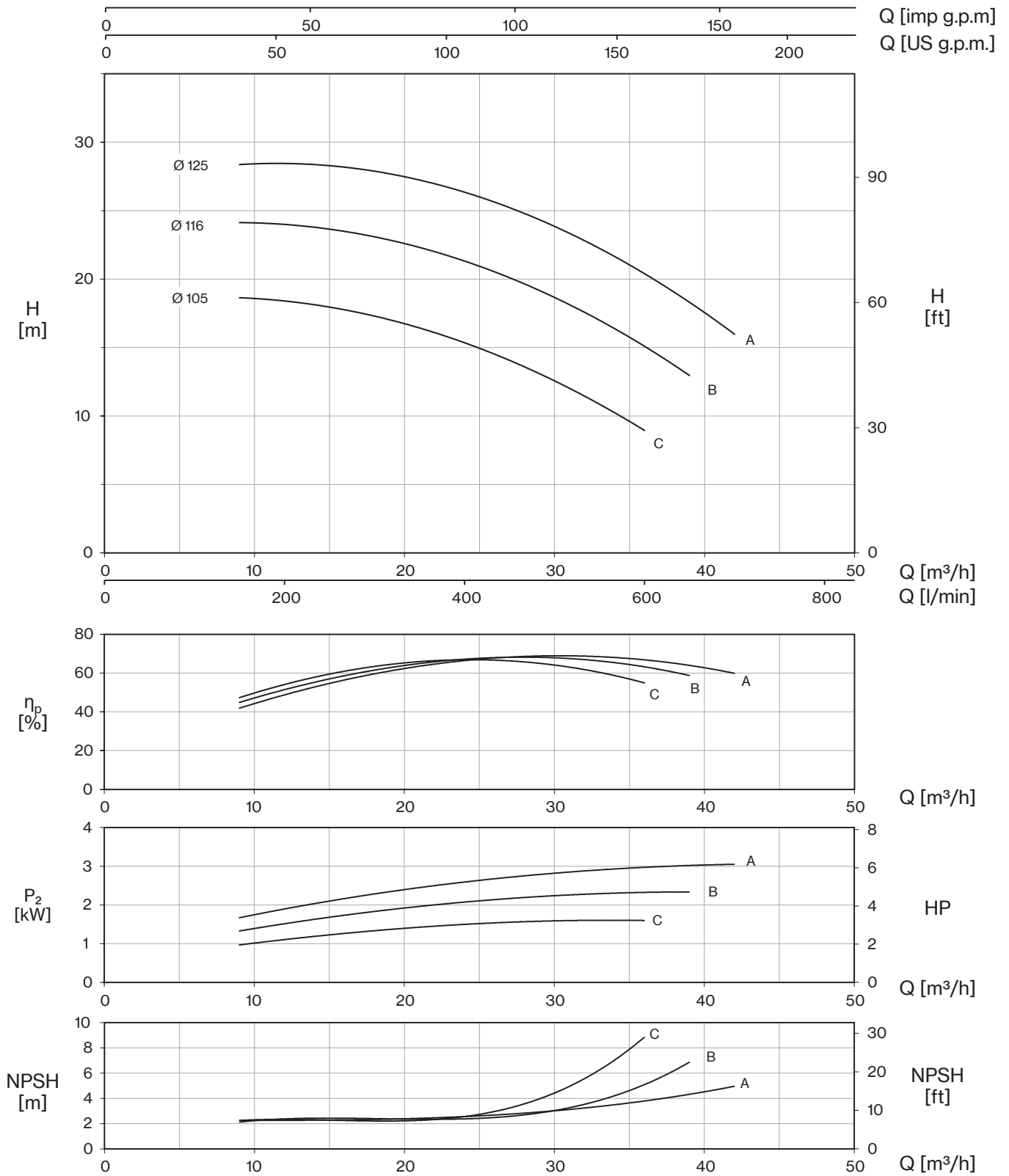

40-160

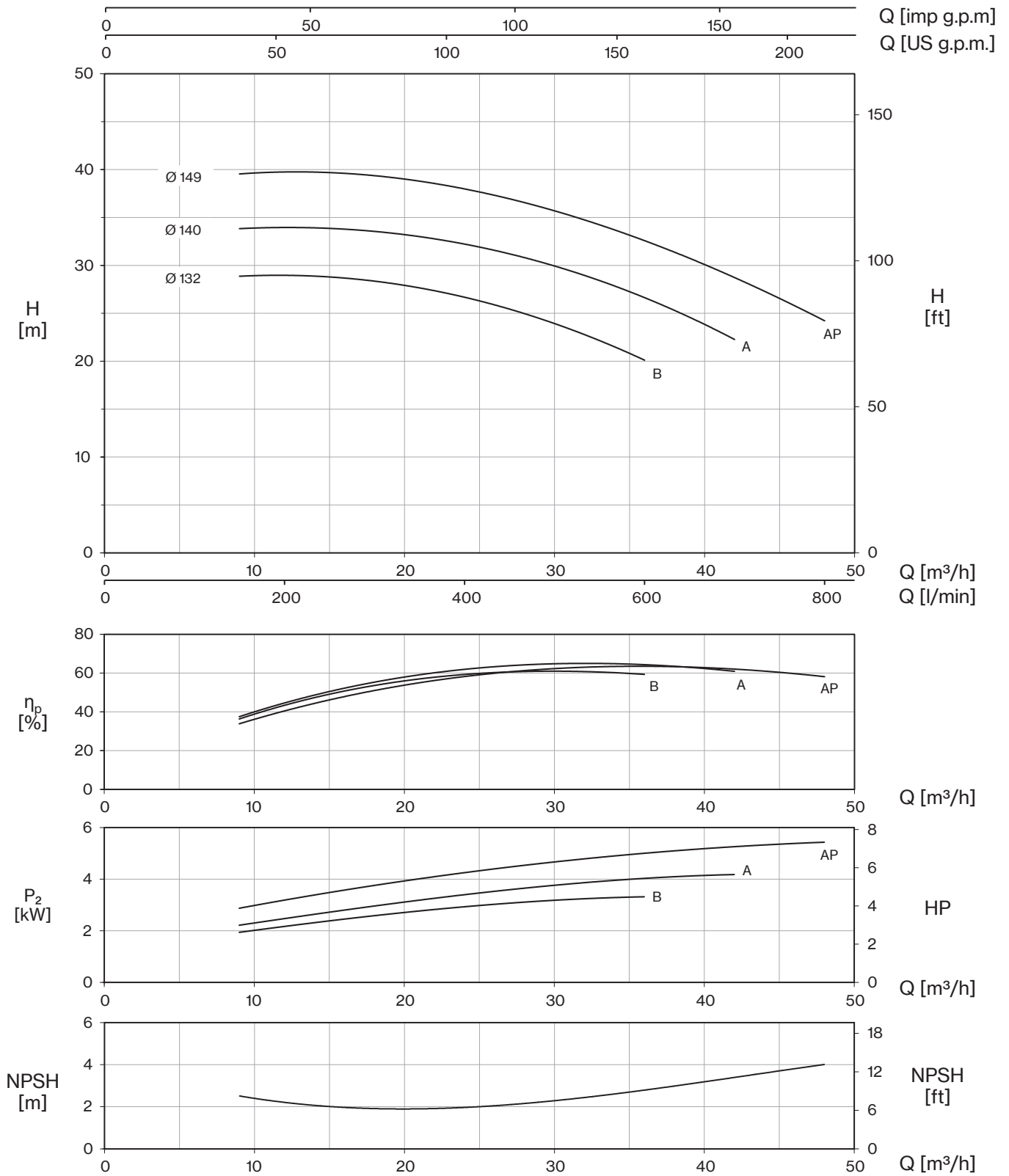

40-200

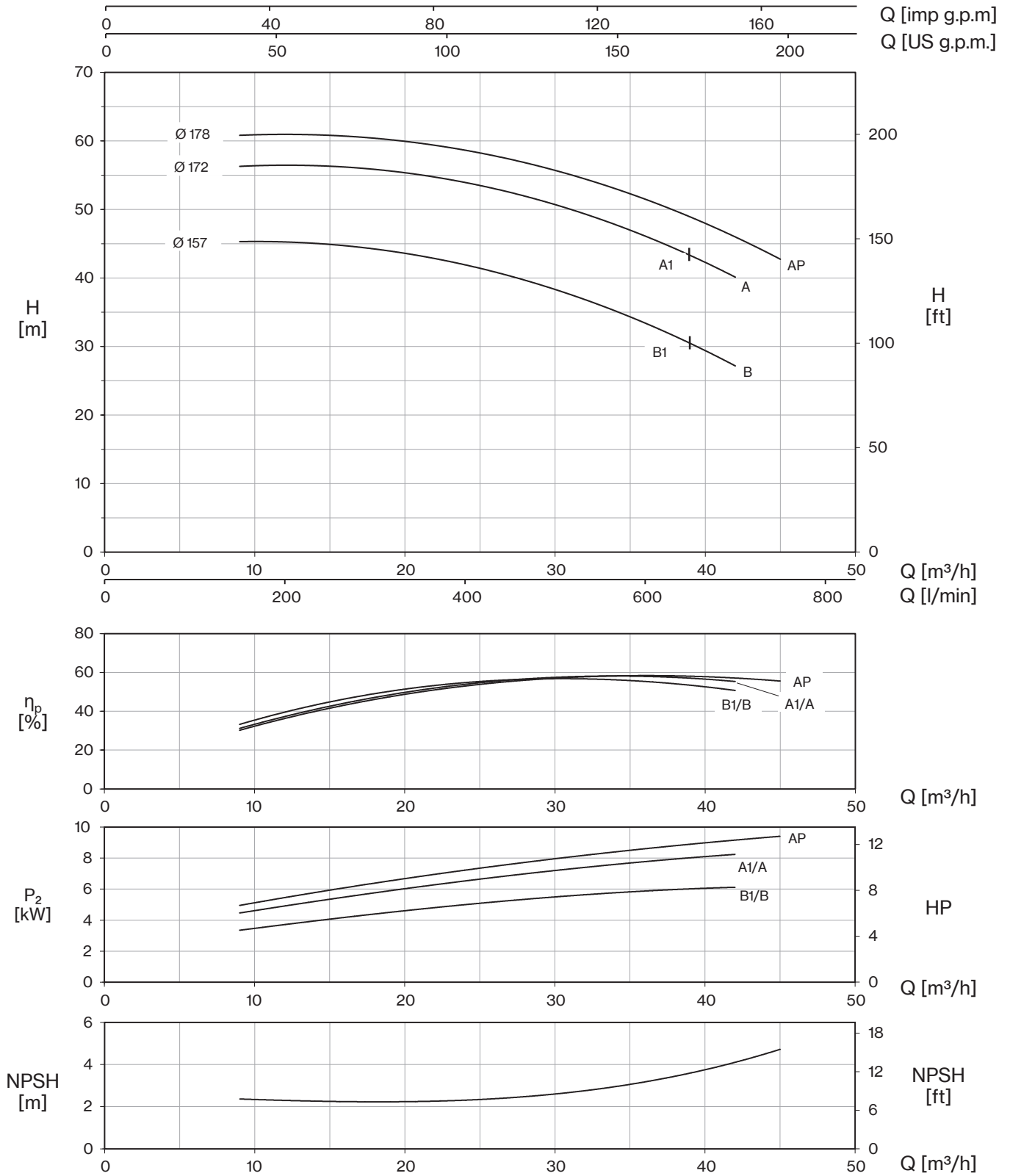

40-250

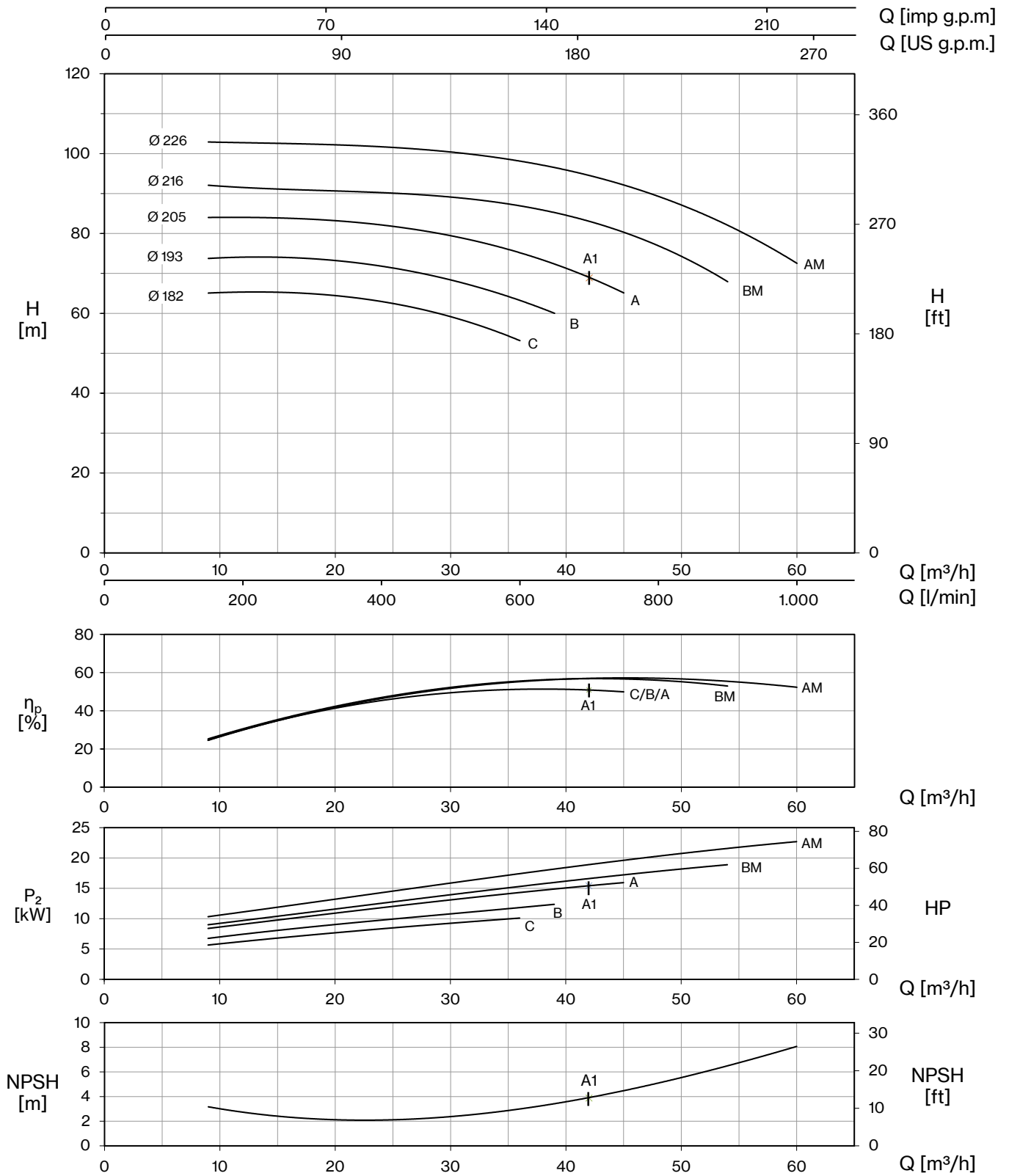

50-125

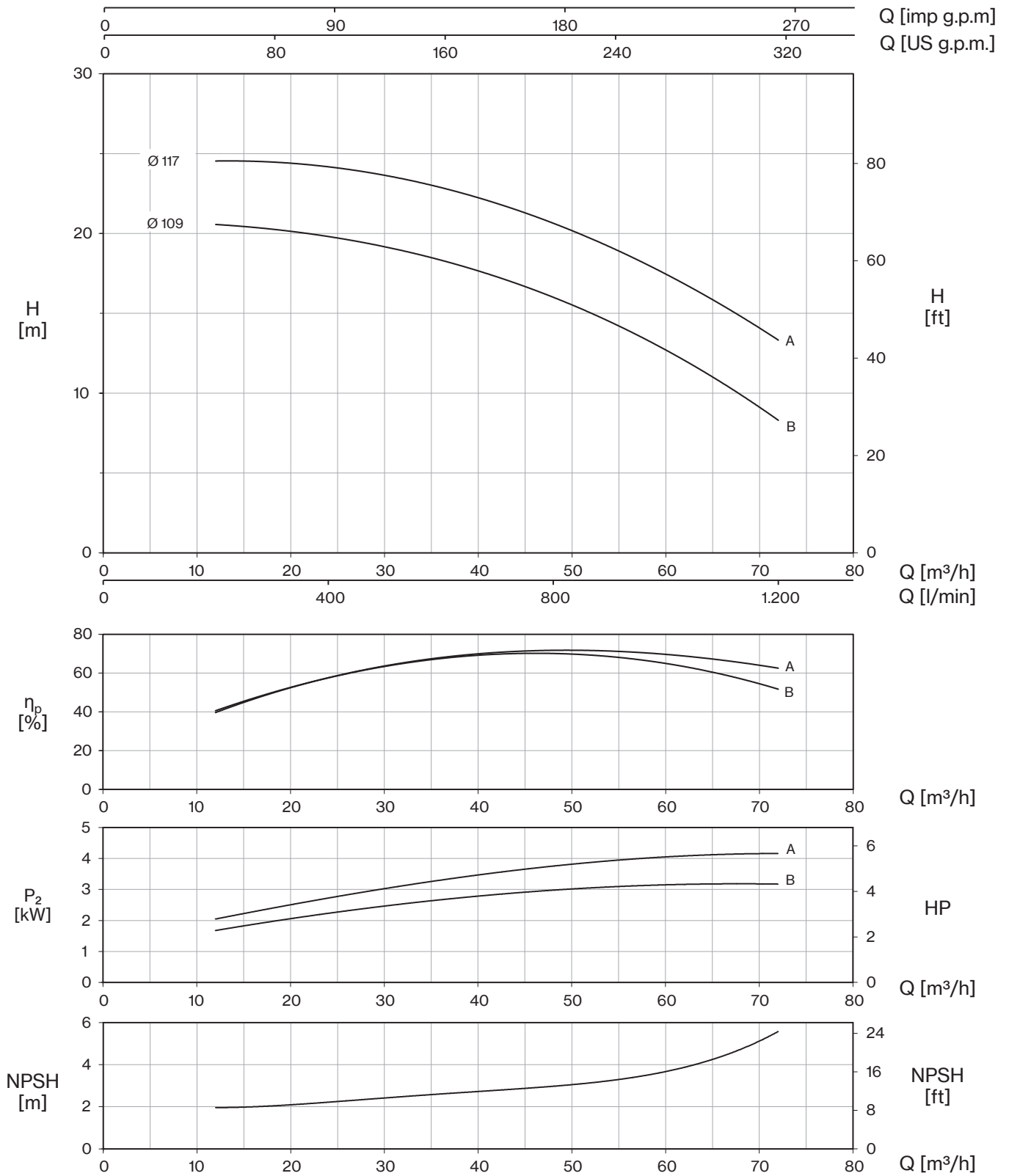

50-160

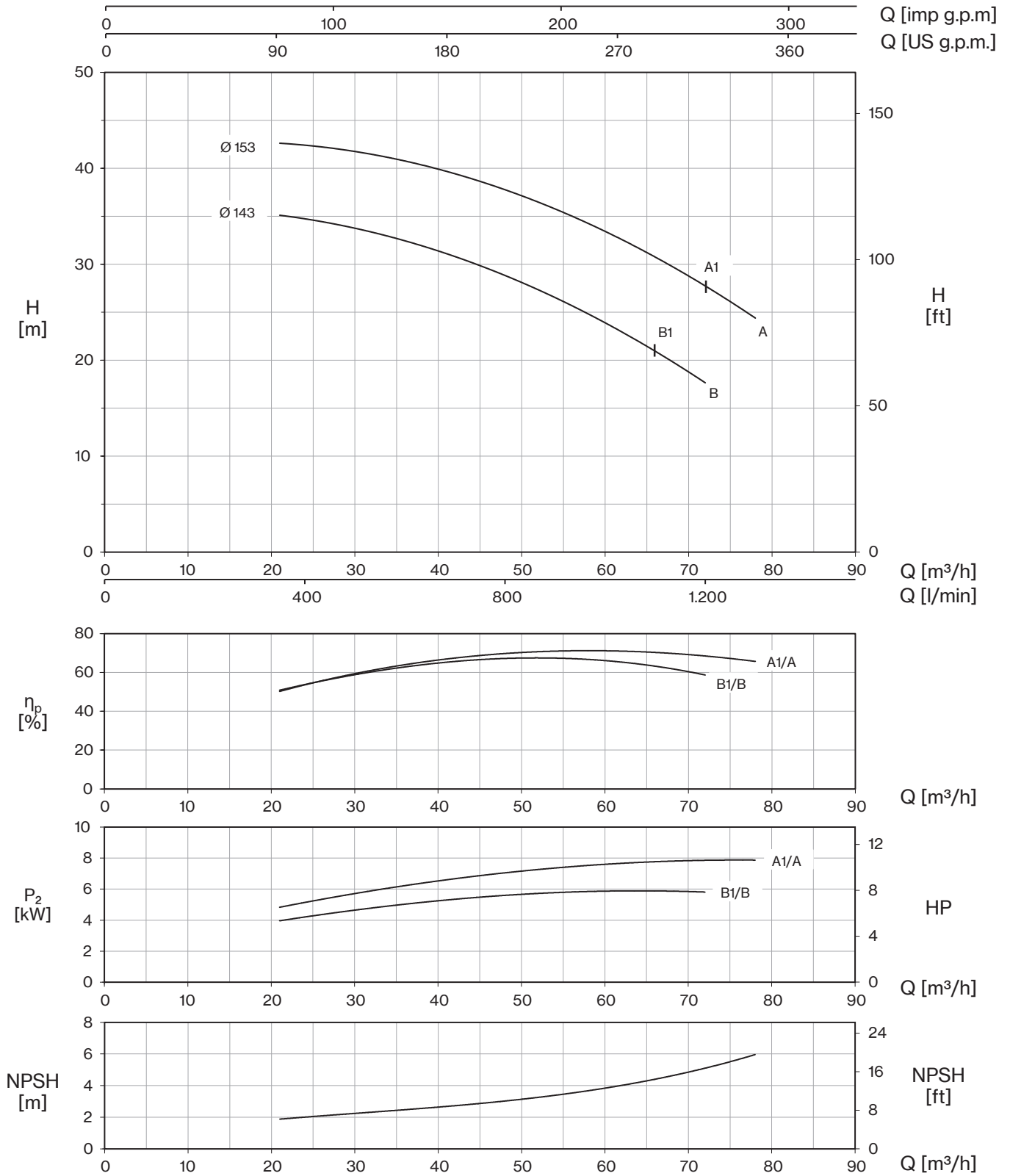

50-200

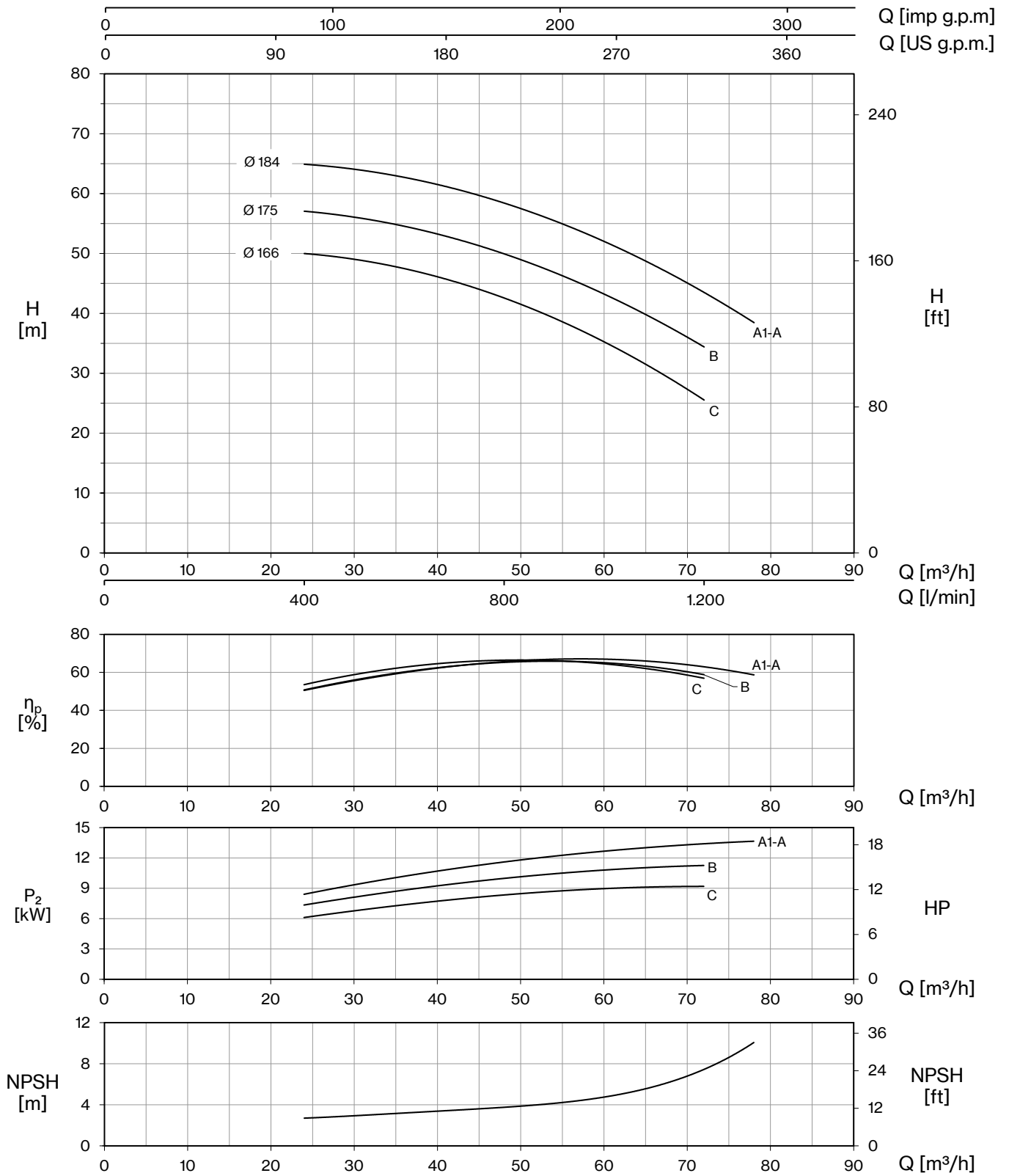

50-250

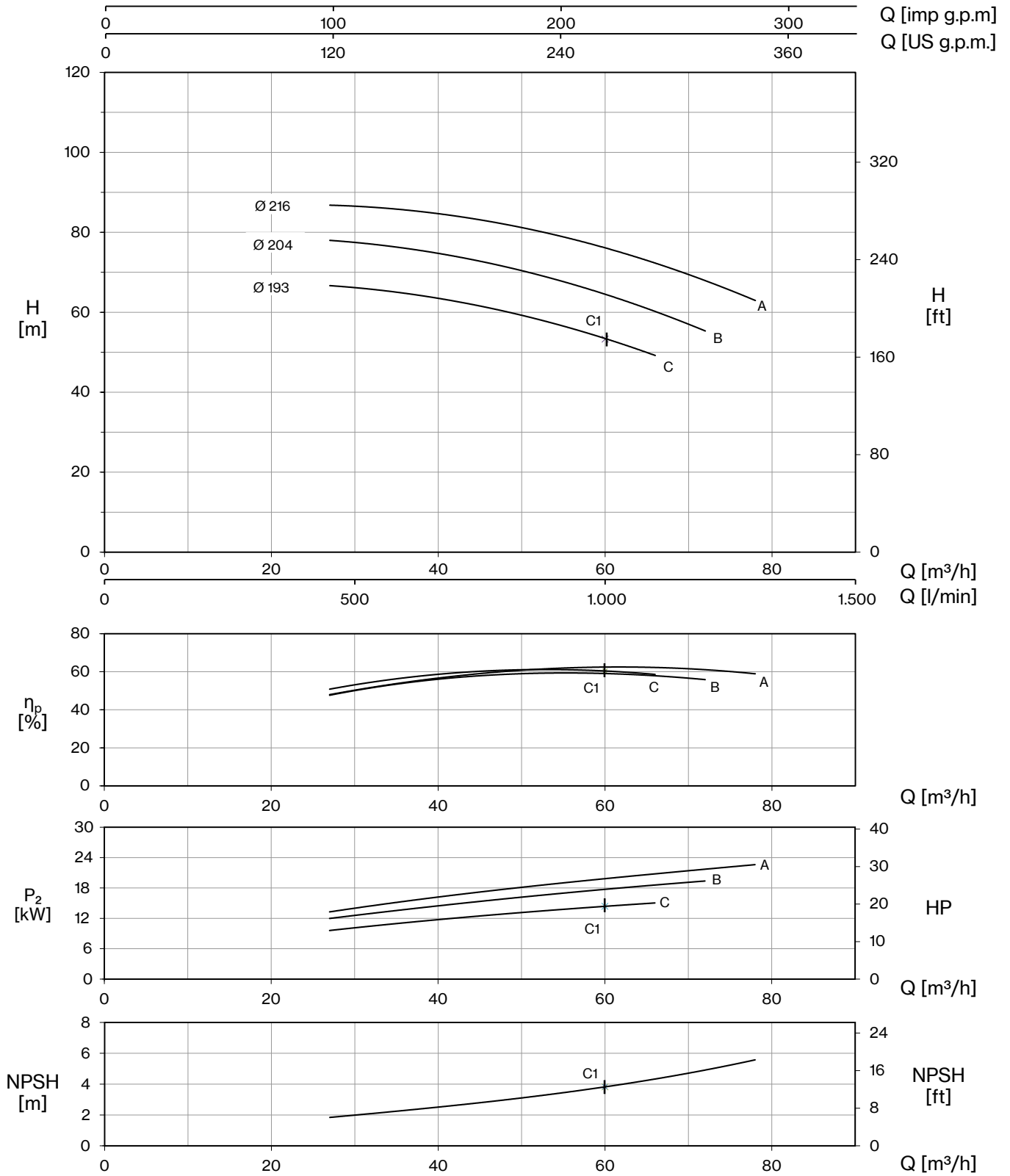

50-315

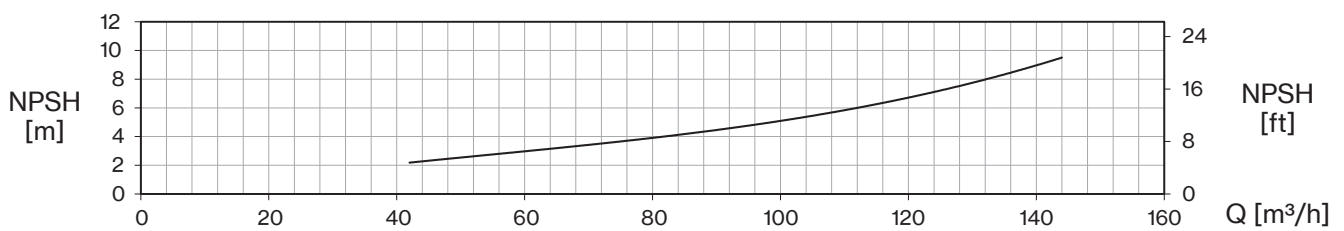
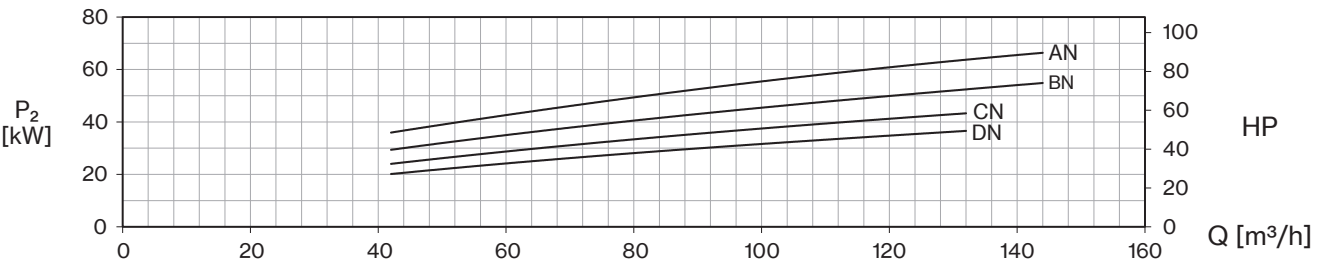
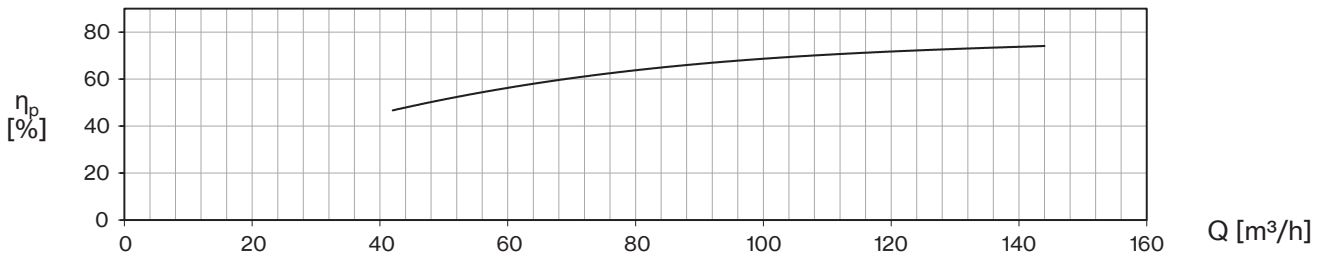
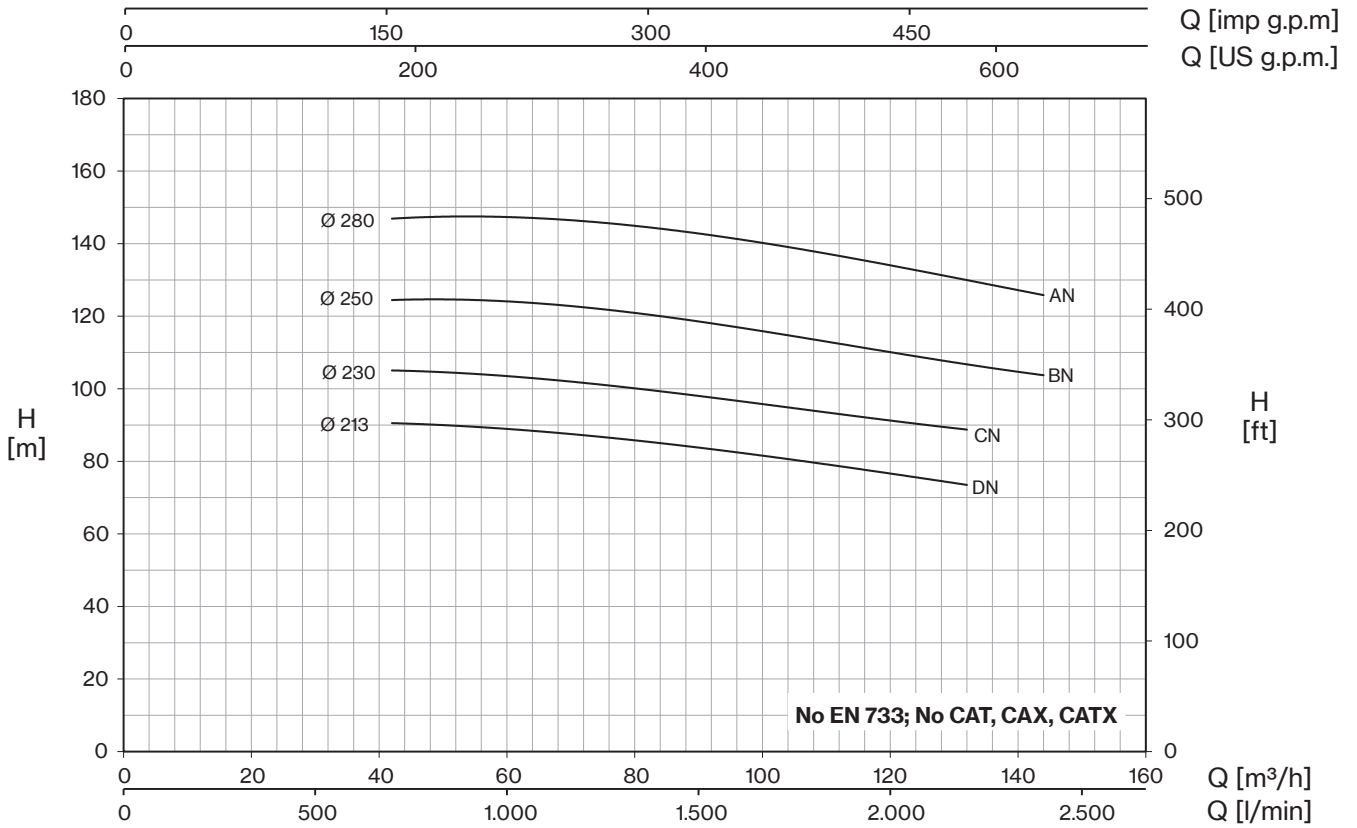

65-125

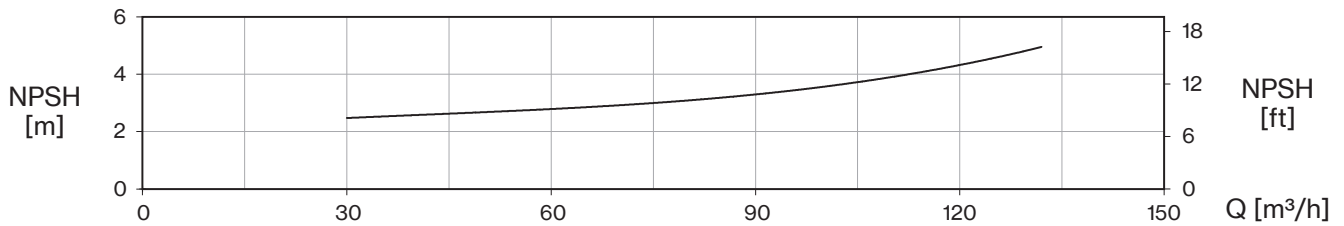
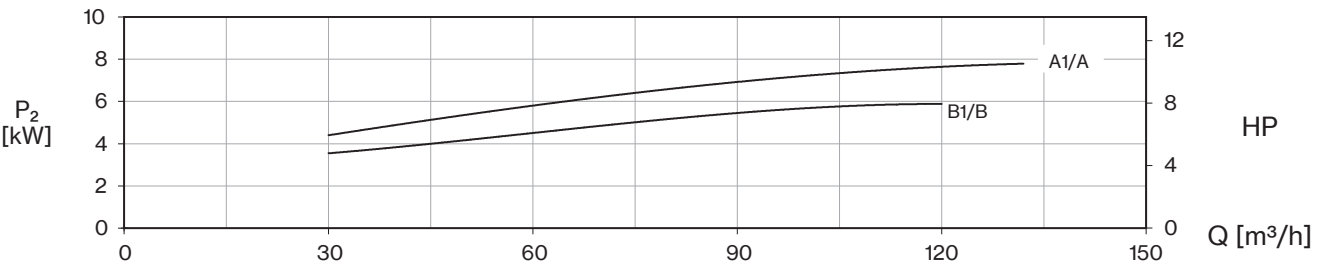
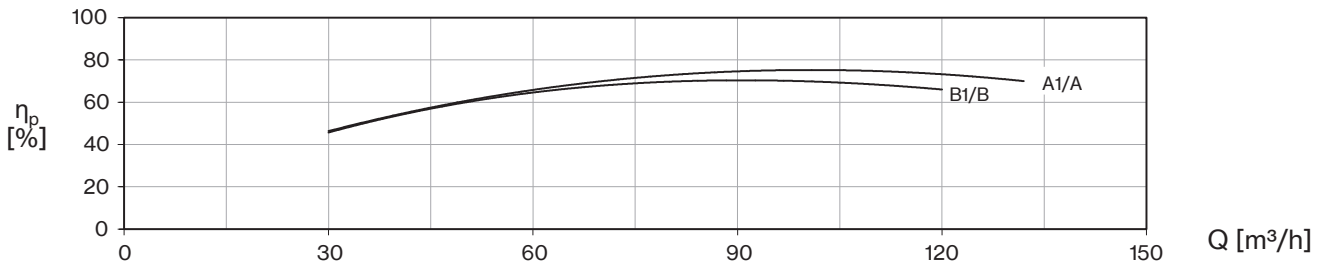
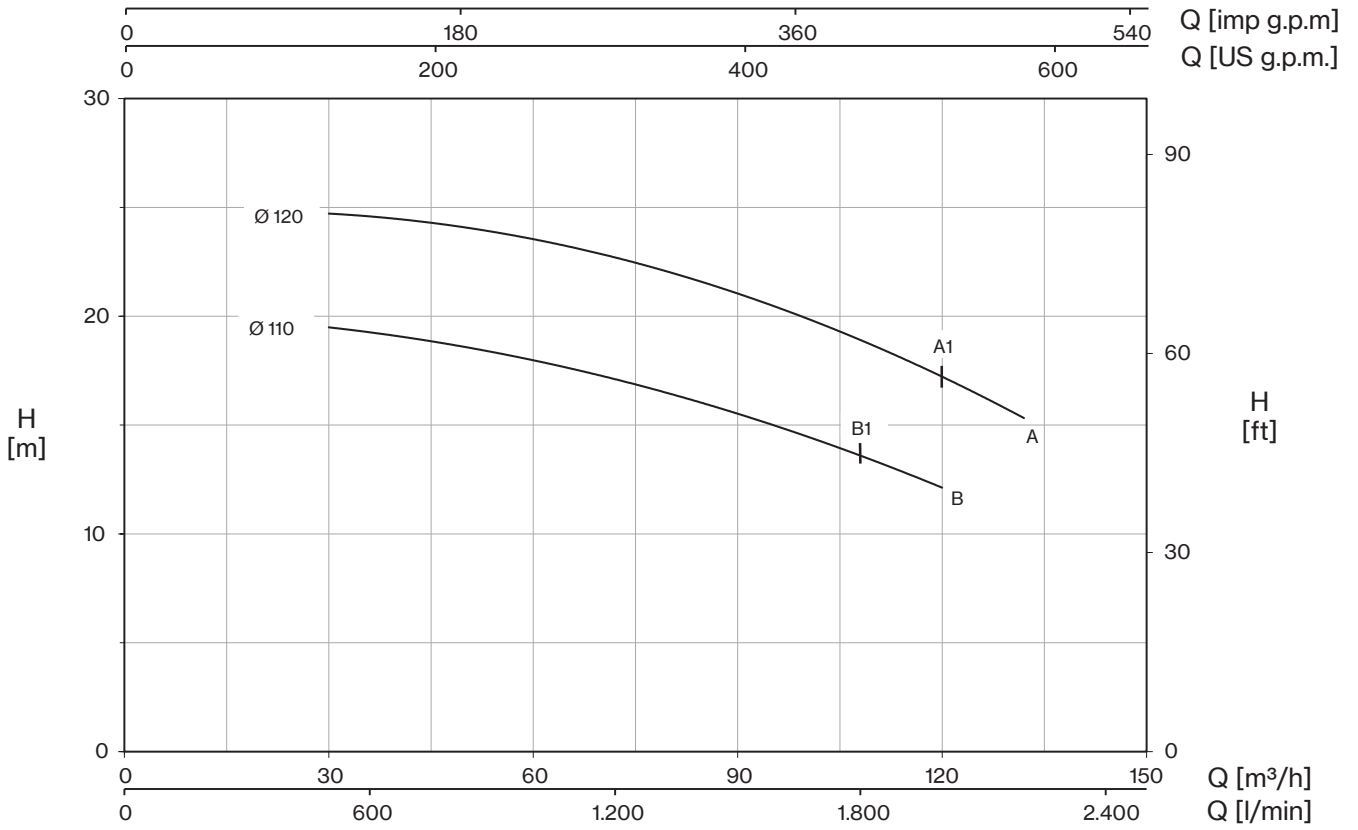

65-160

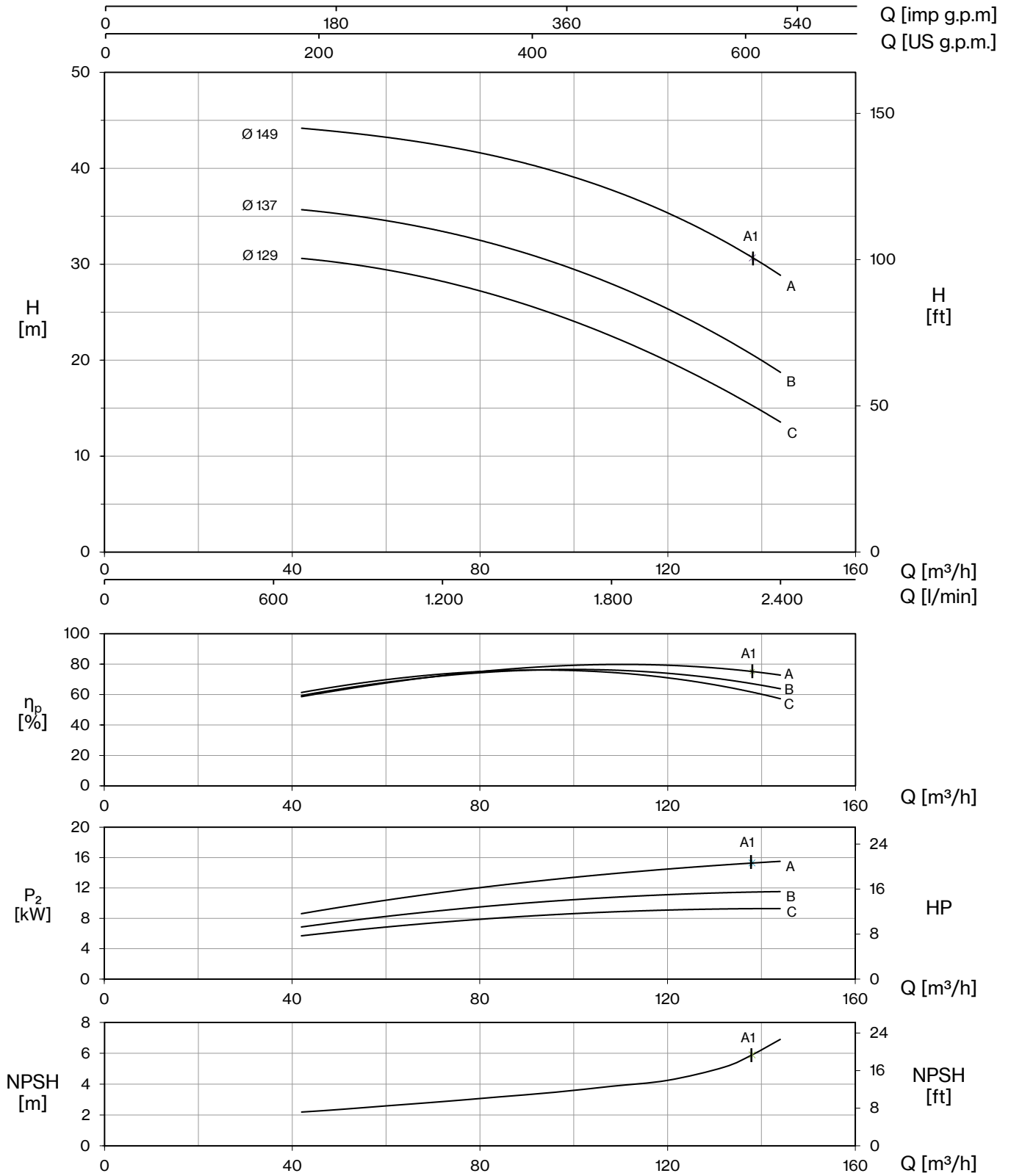

65-200

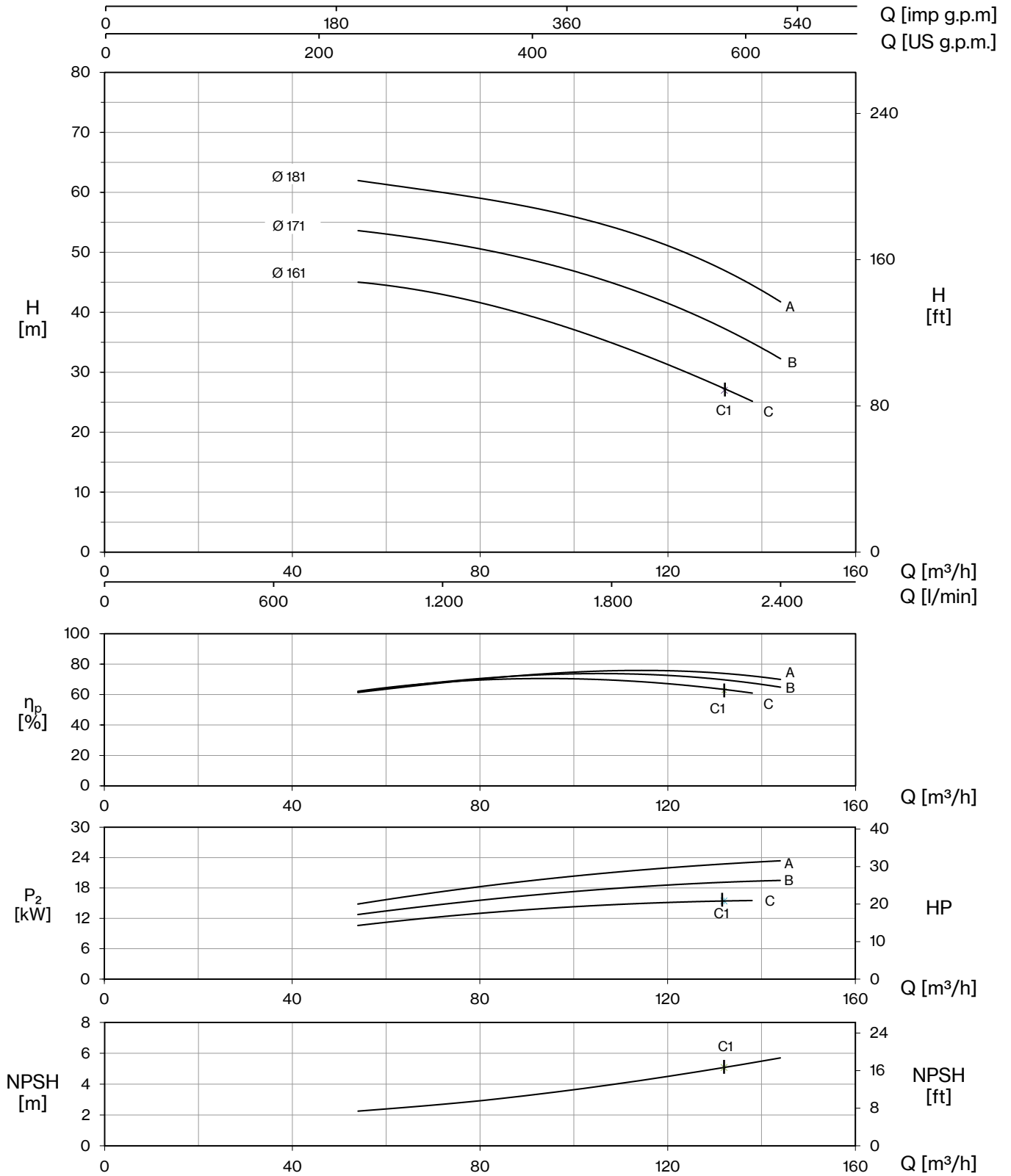

65-250

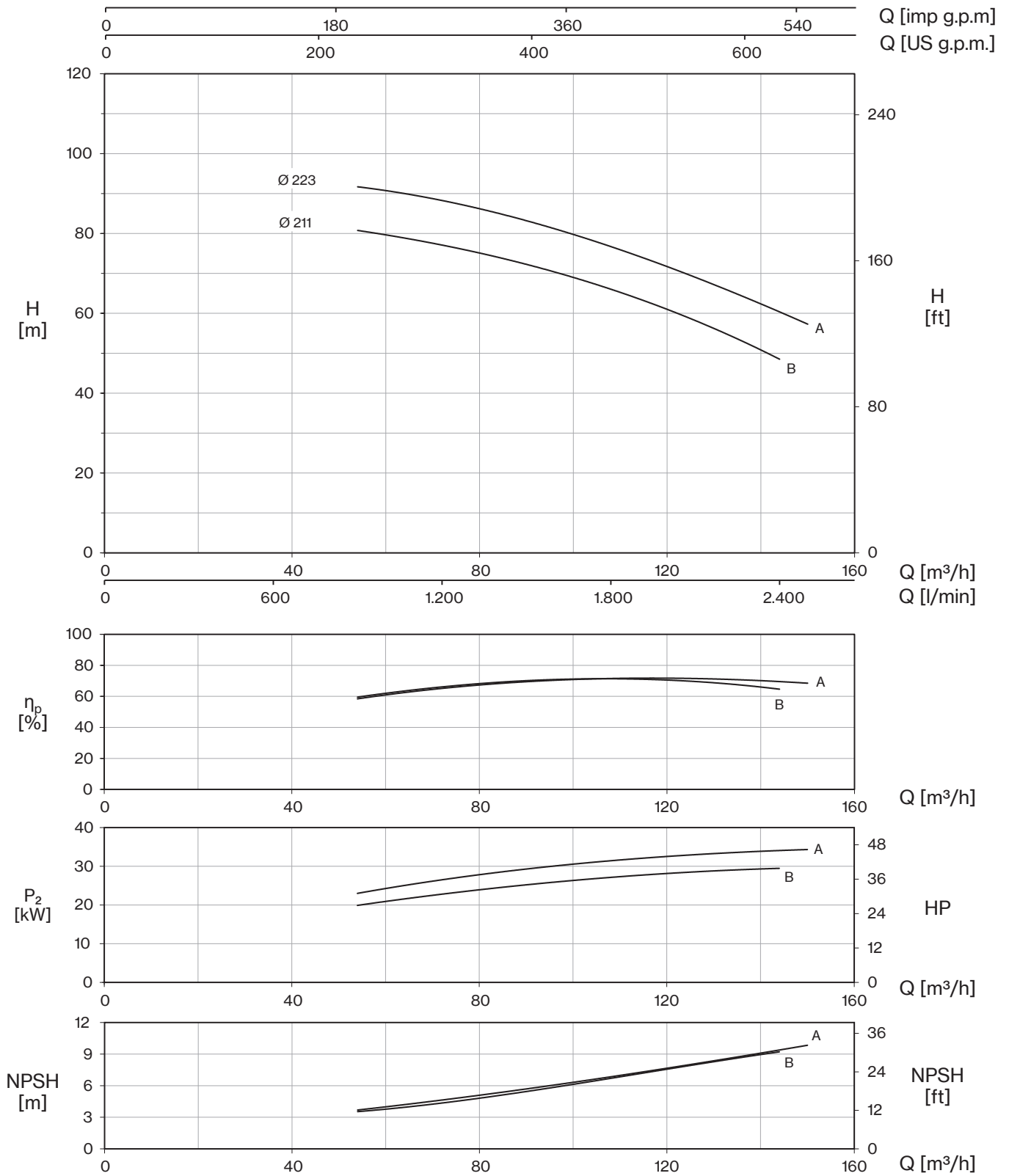

65-315

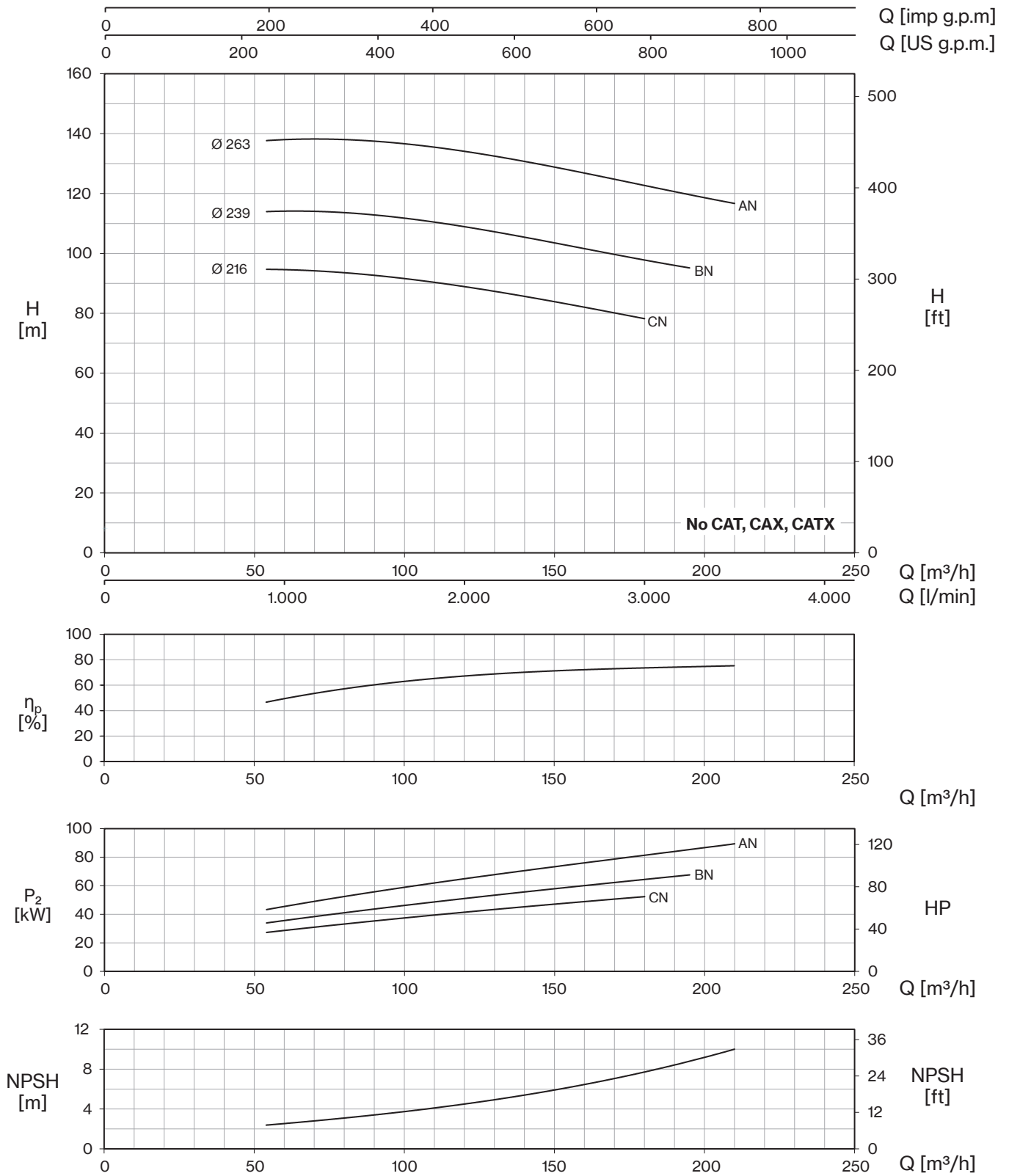

80-160

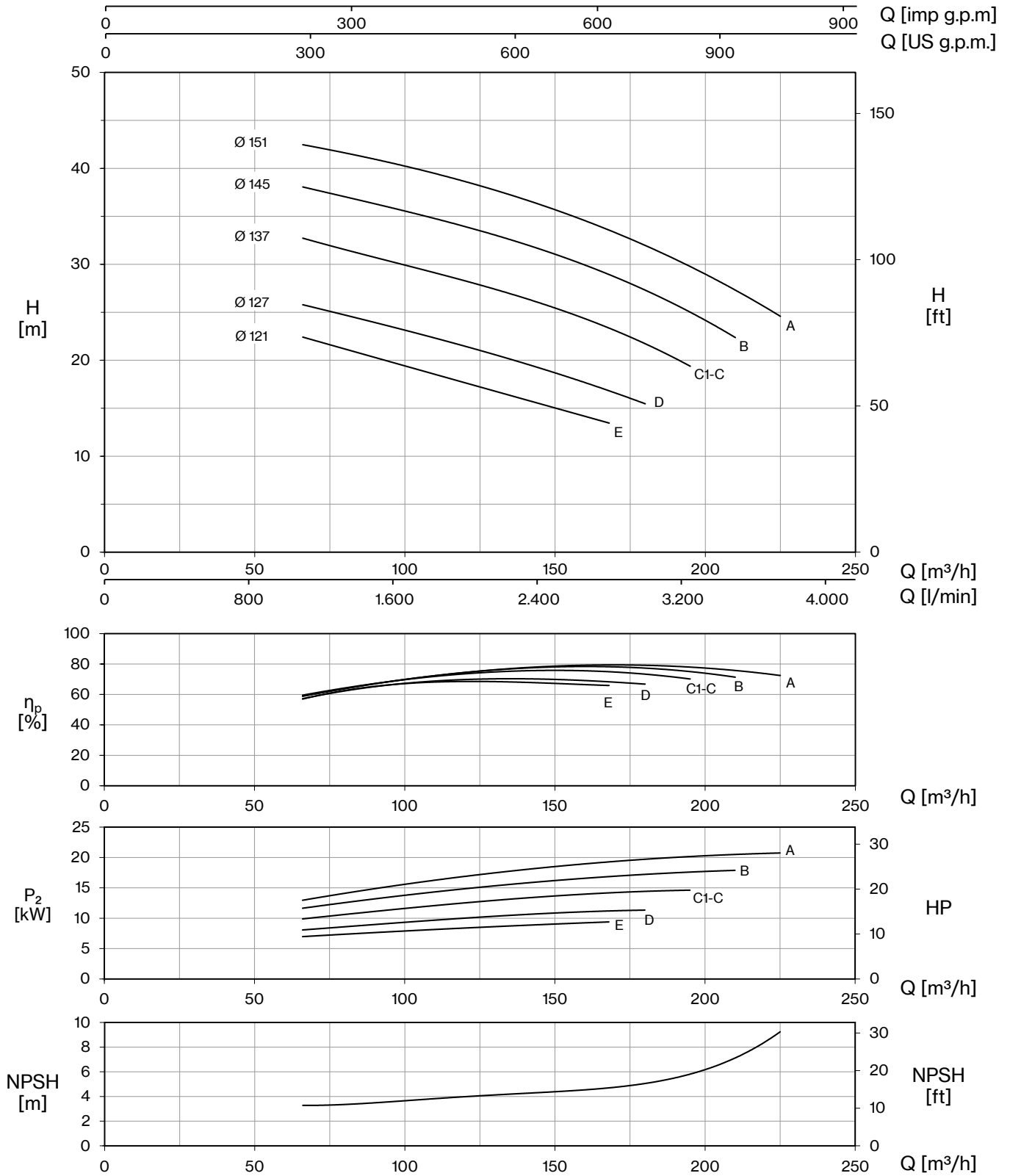

80-200

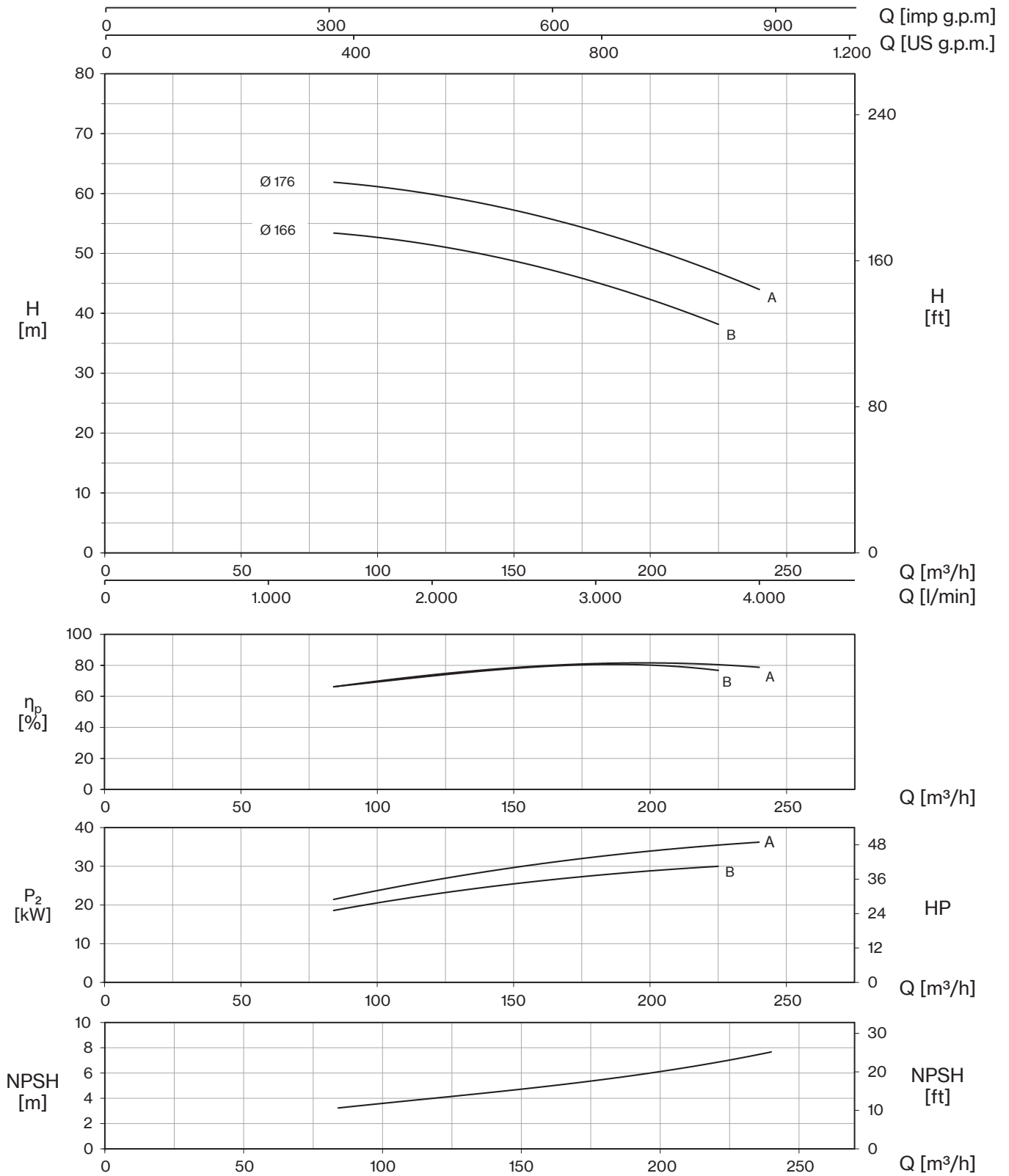

80-250

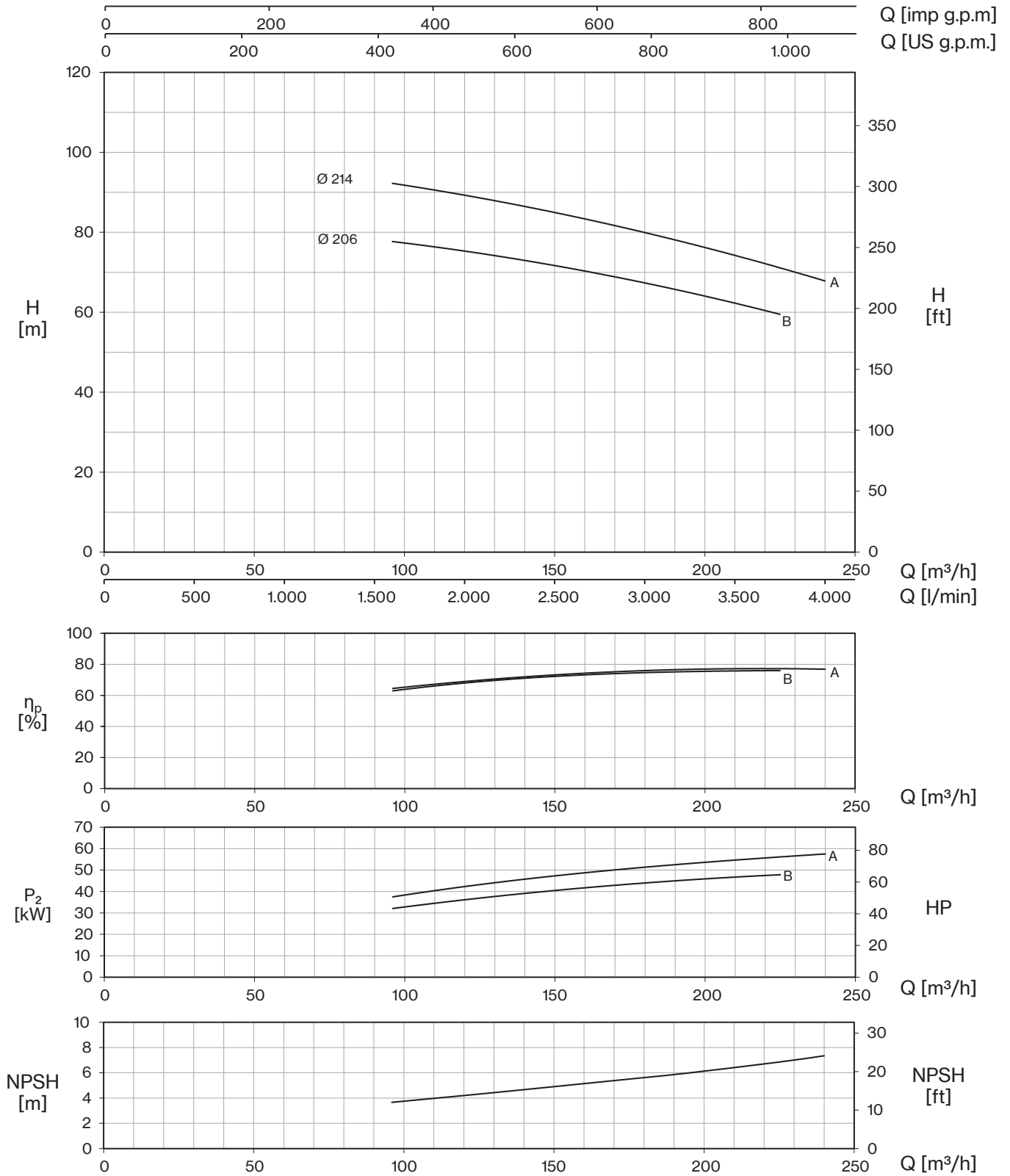

100-160

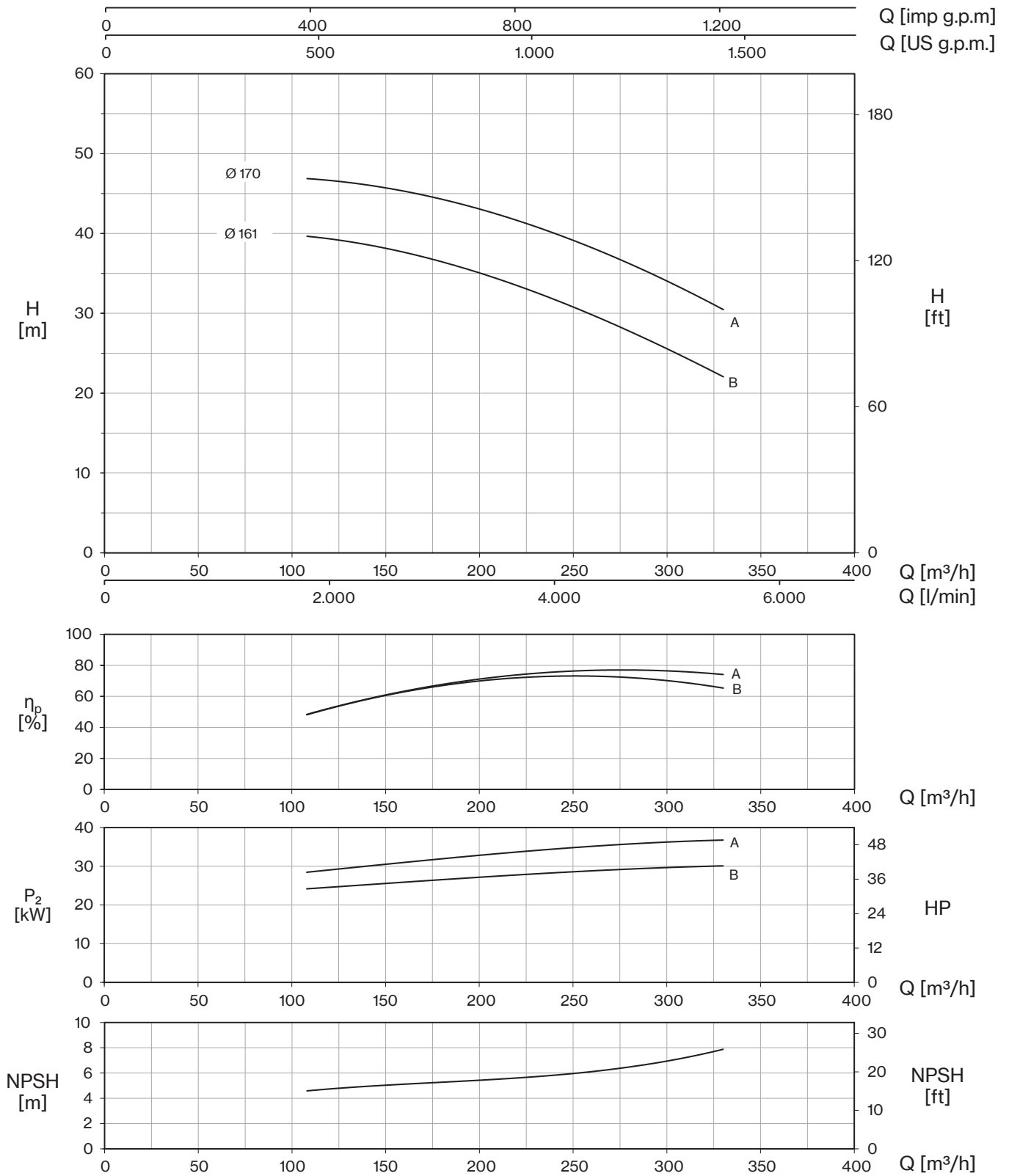

100-200

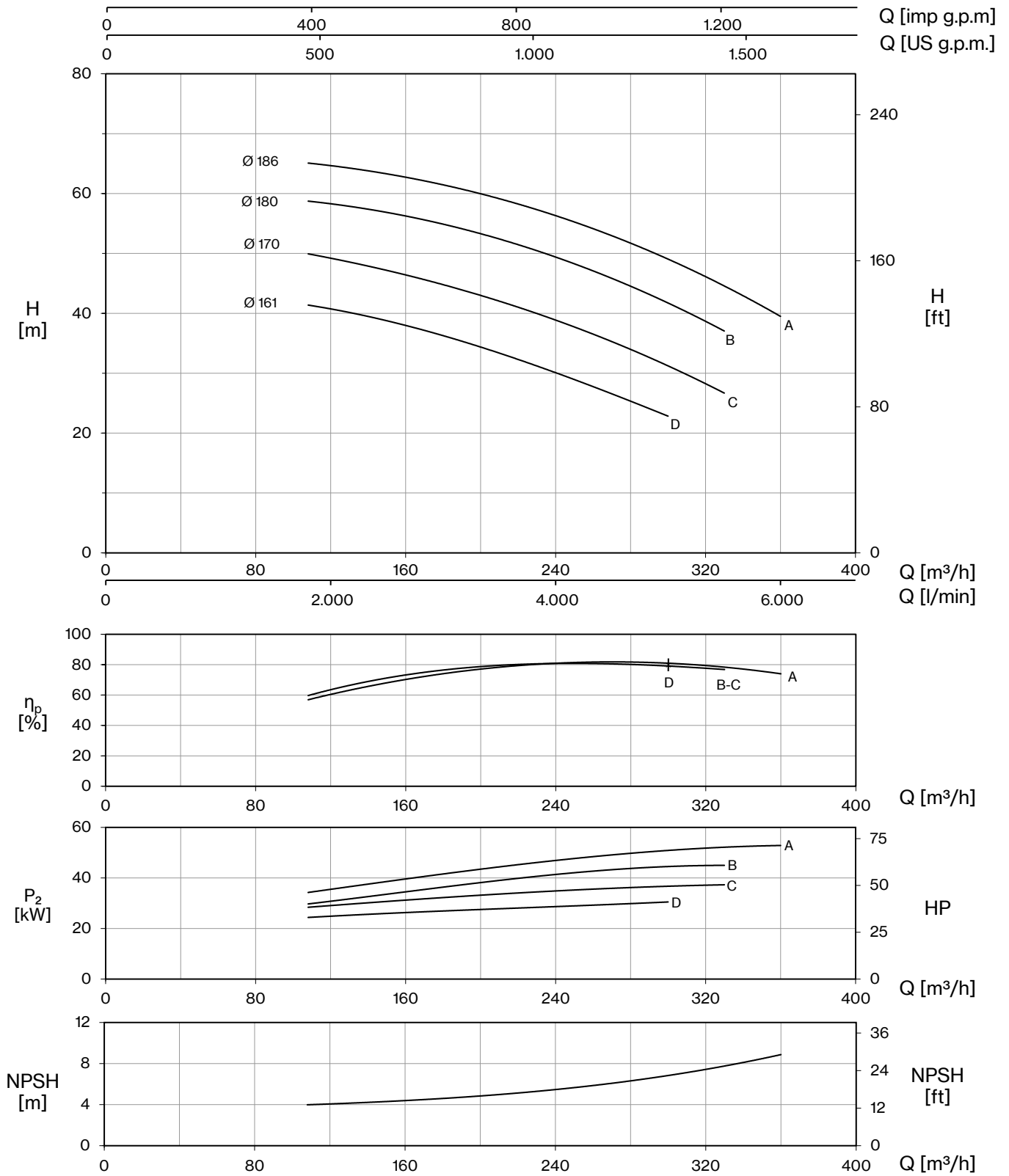

100-250

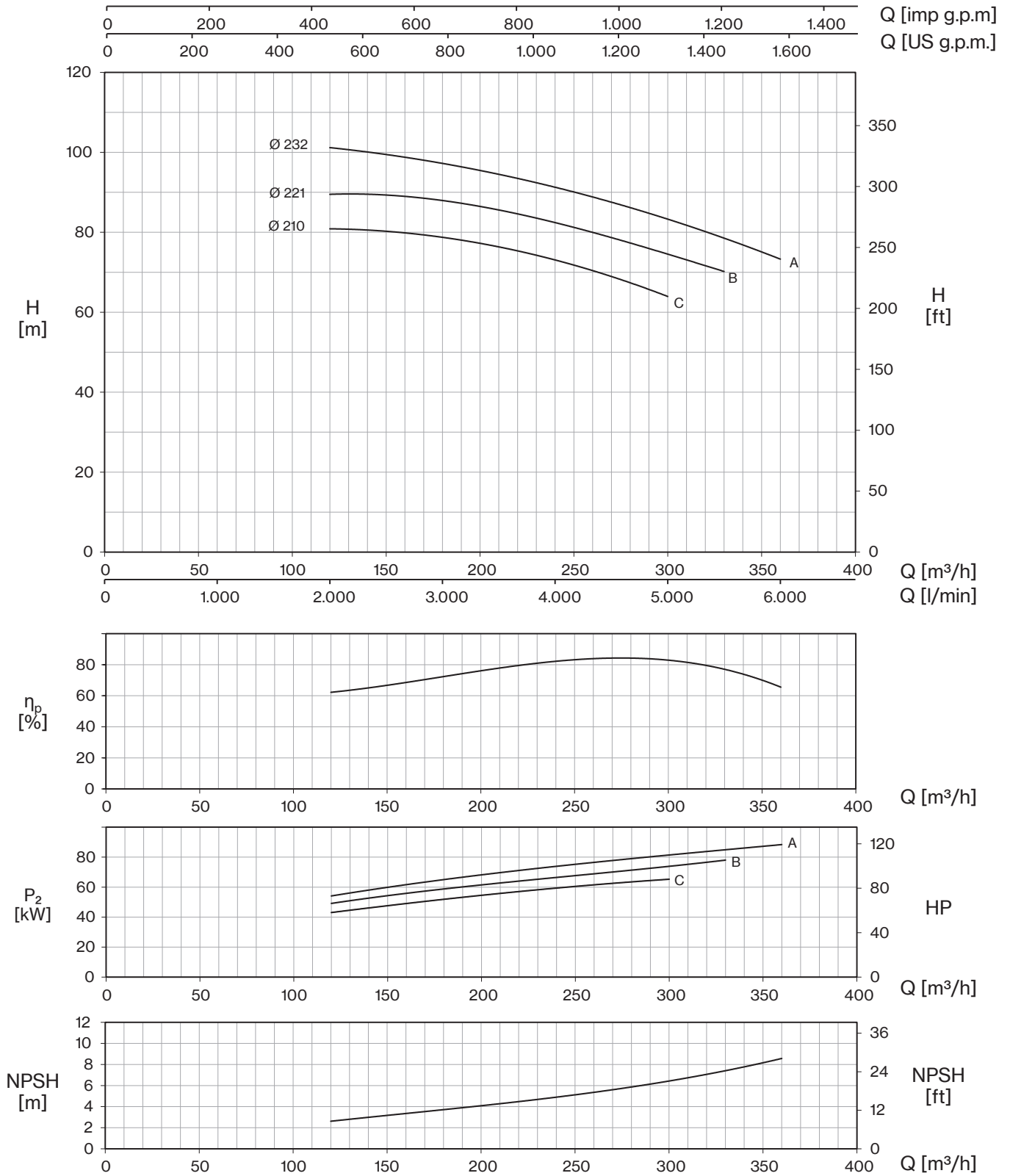

32-160

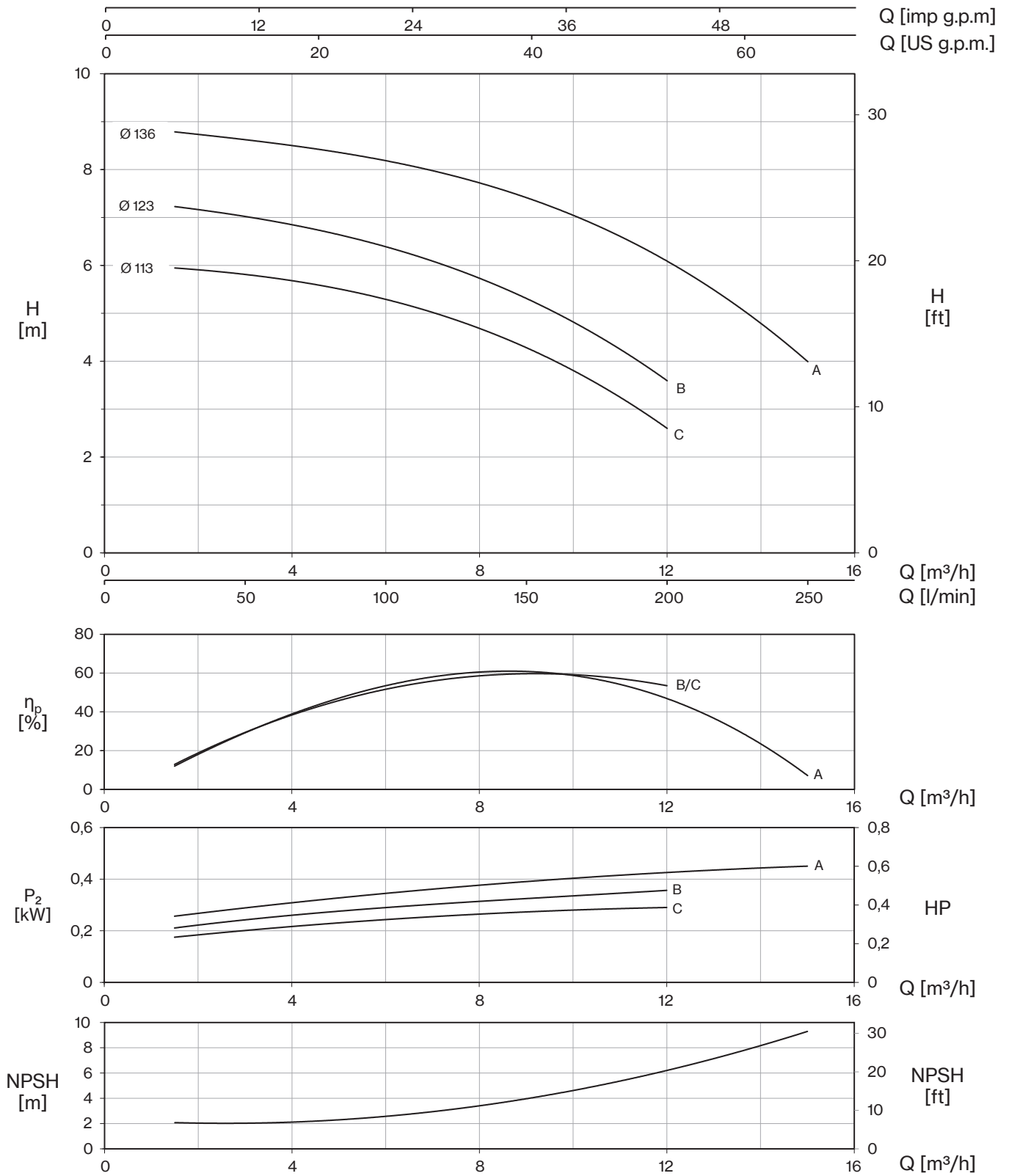

32-200

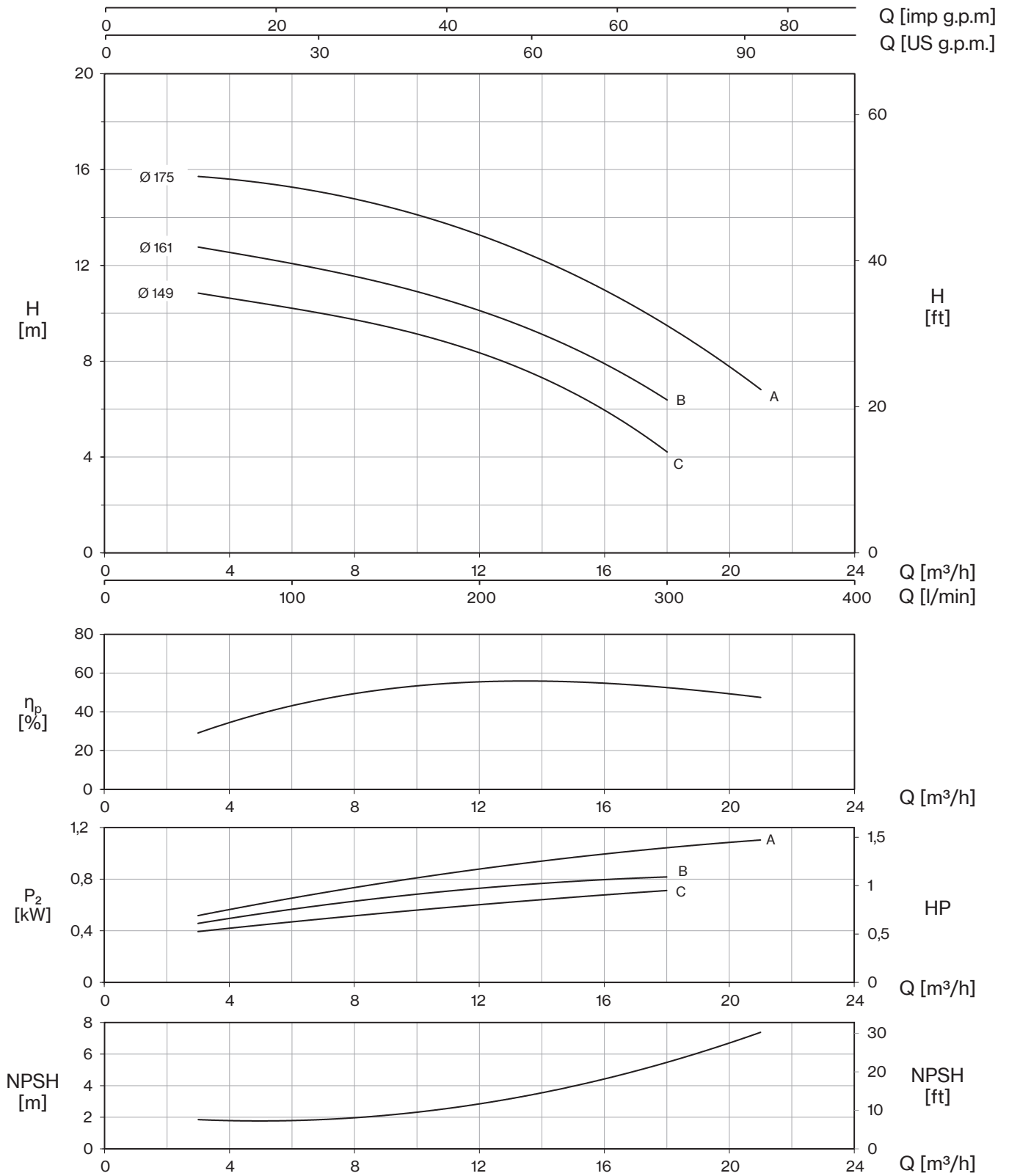

32-250

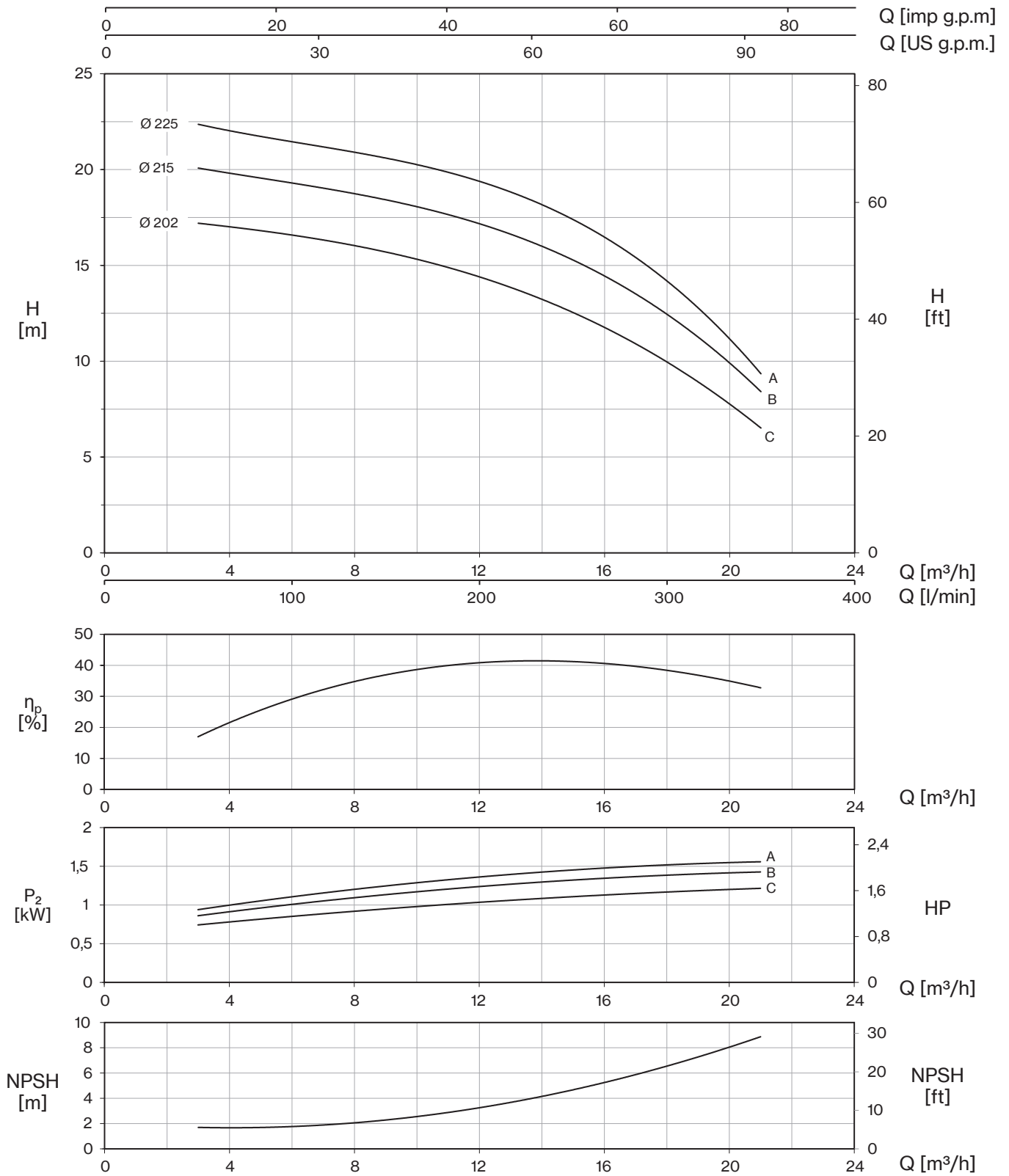

40-125

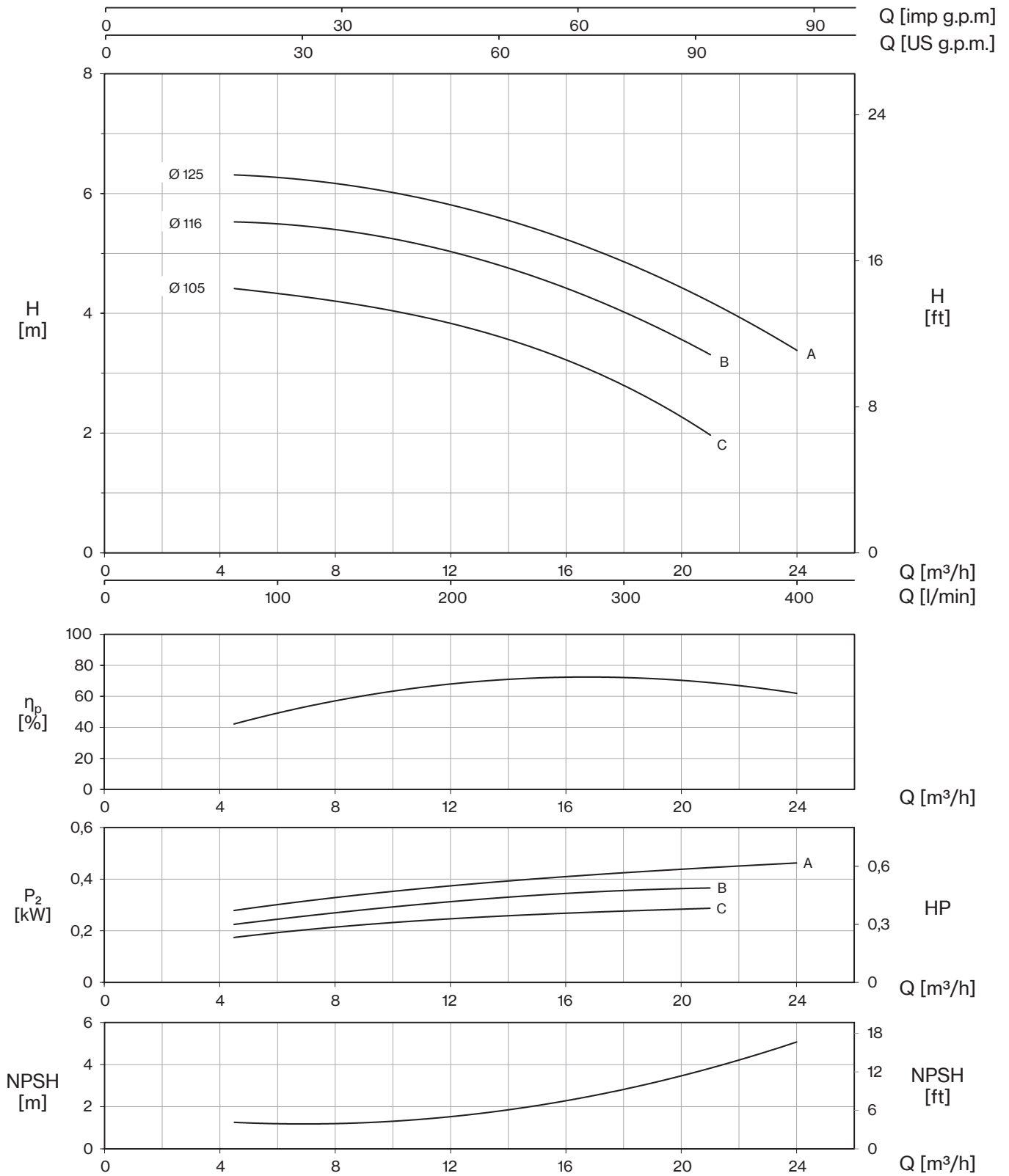

40-160

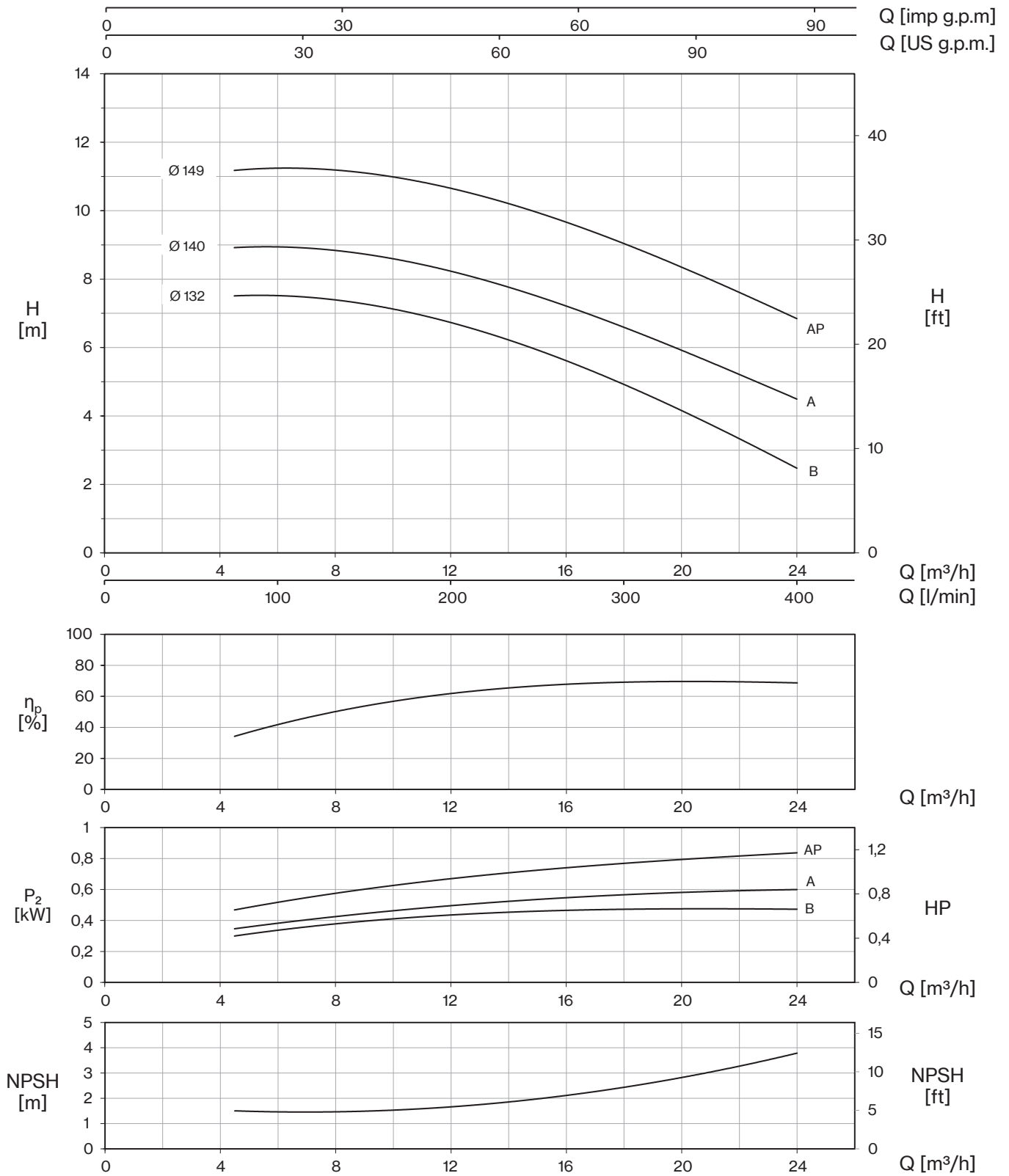

40-200

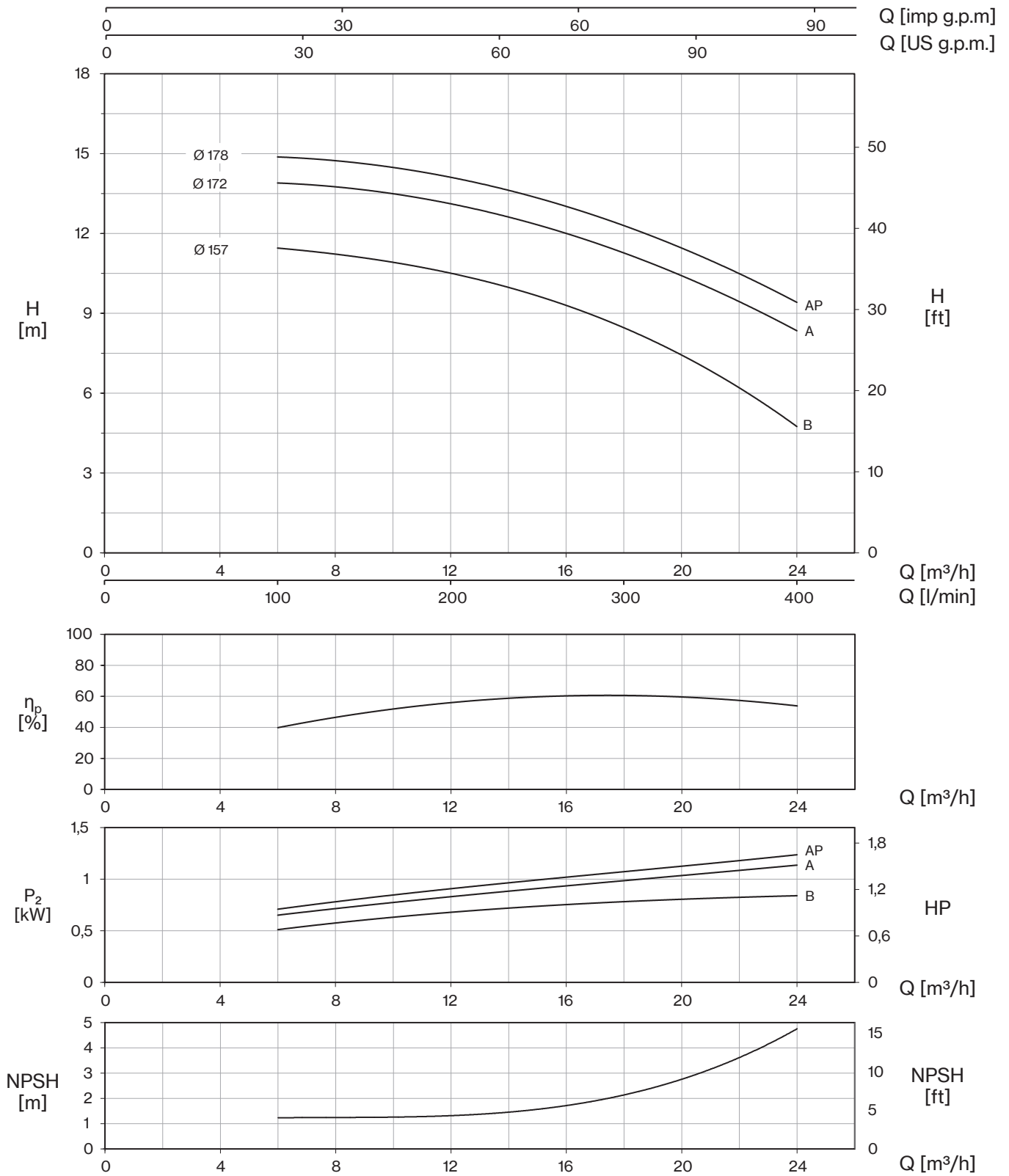

40-250

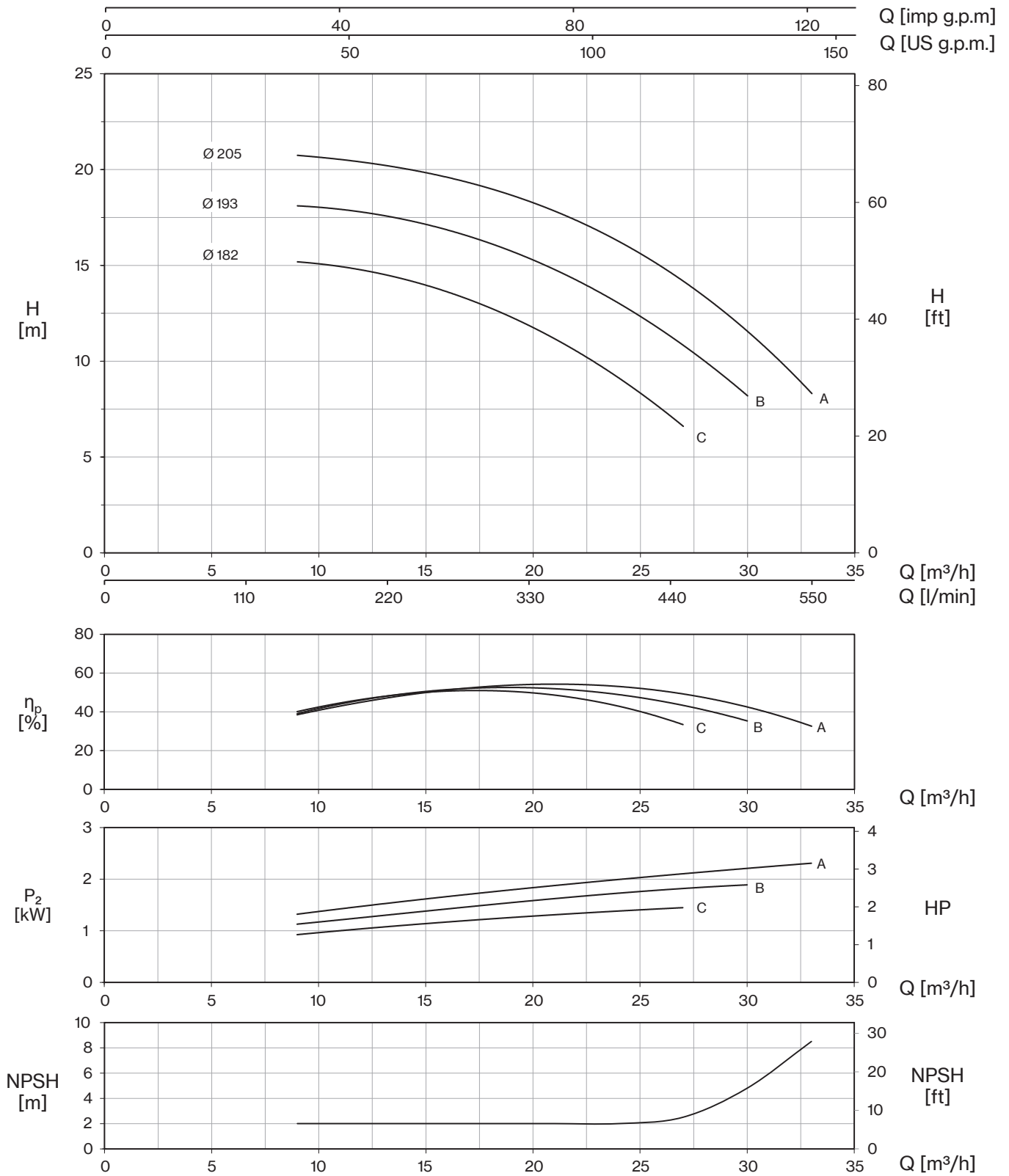

50-125

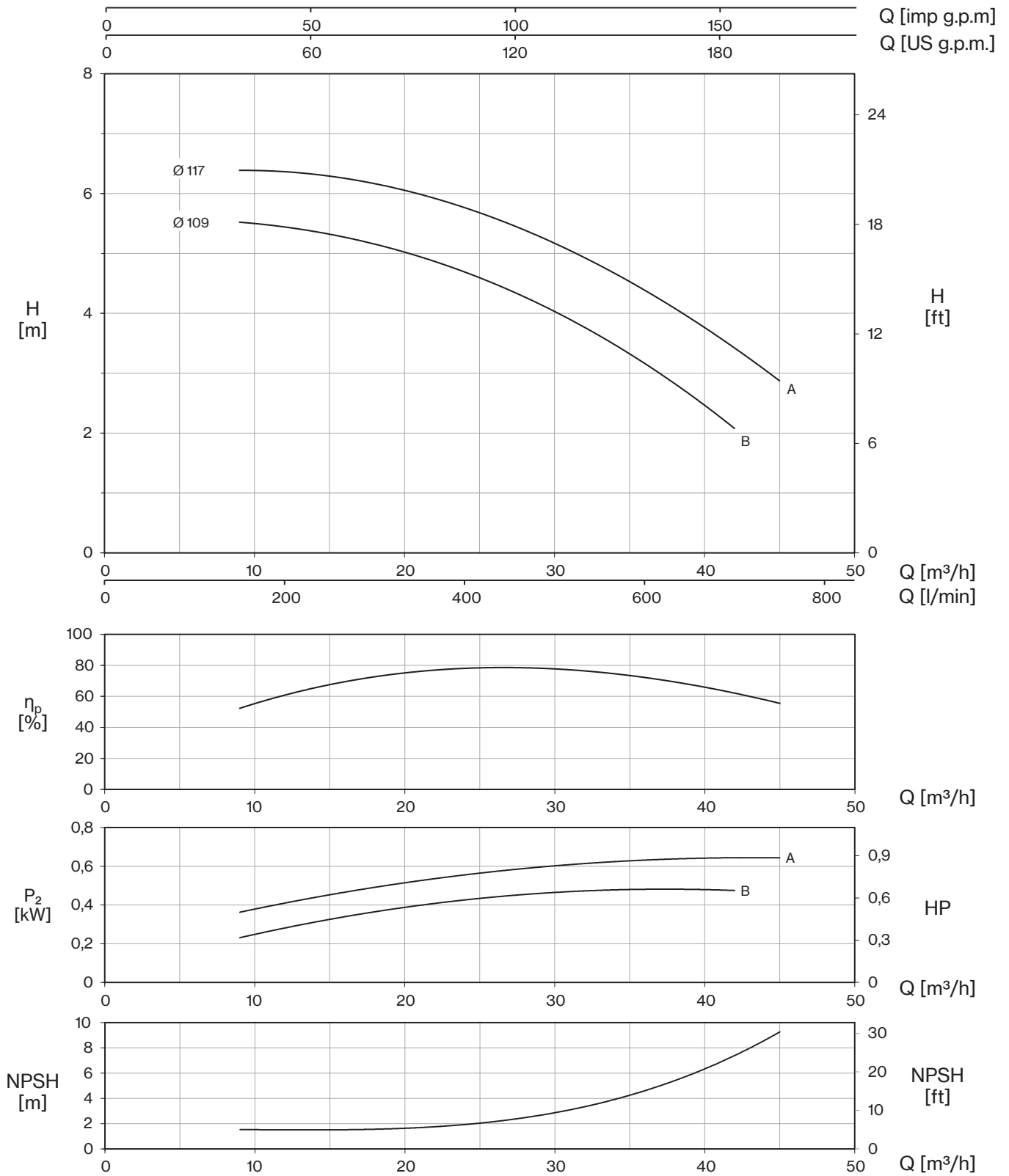

50-160

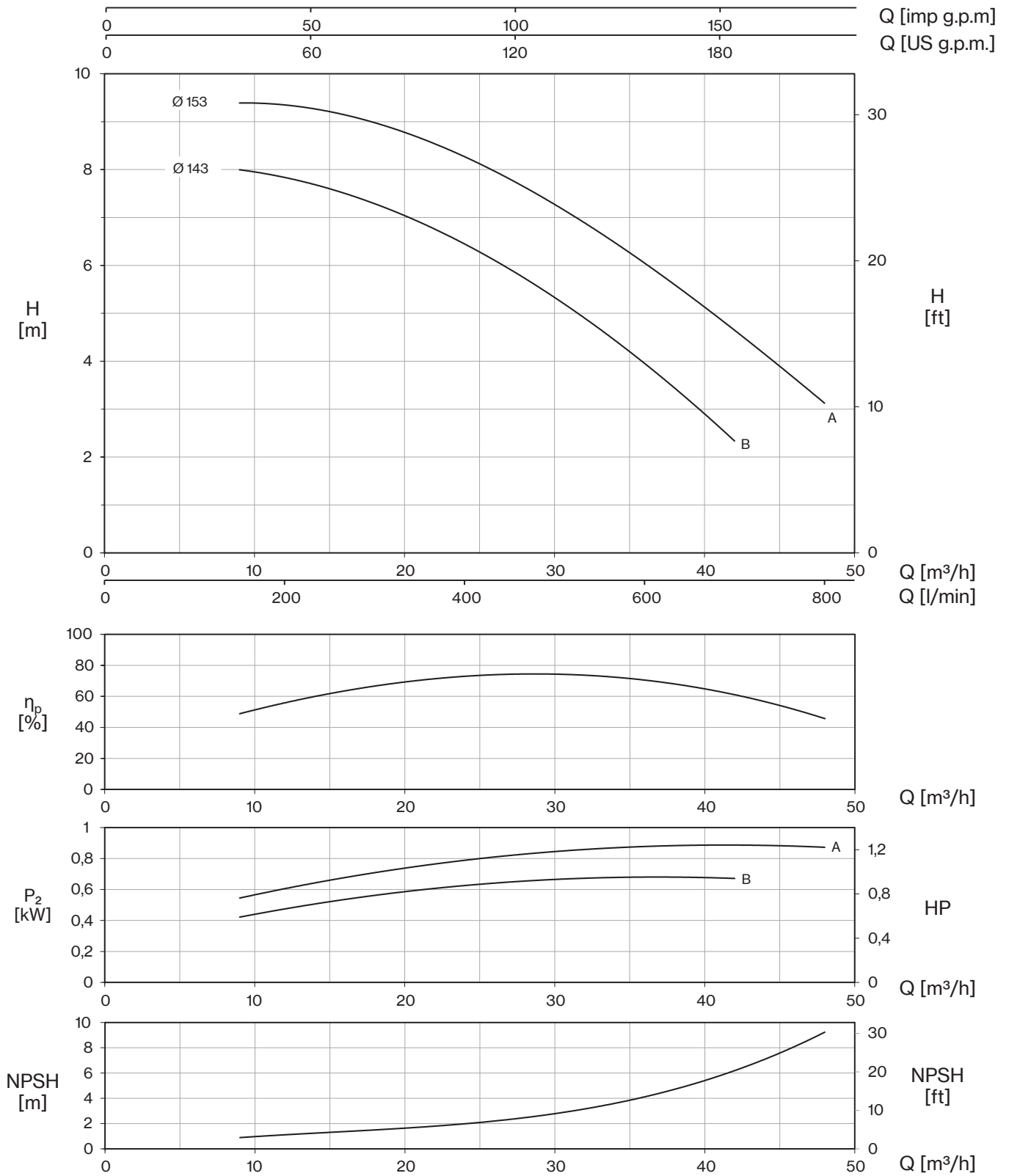

50-200

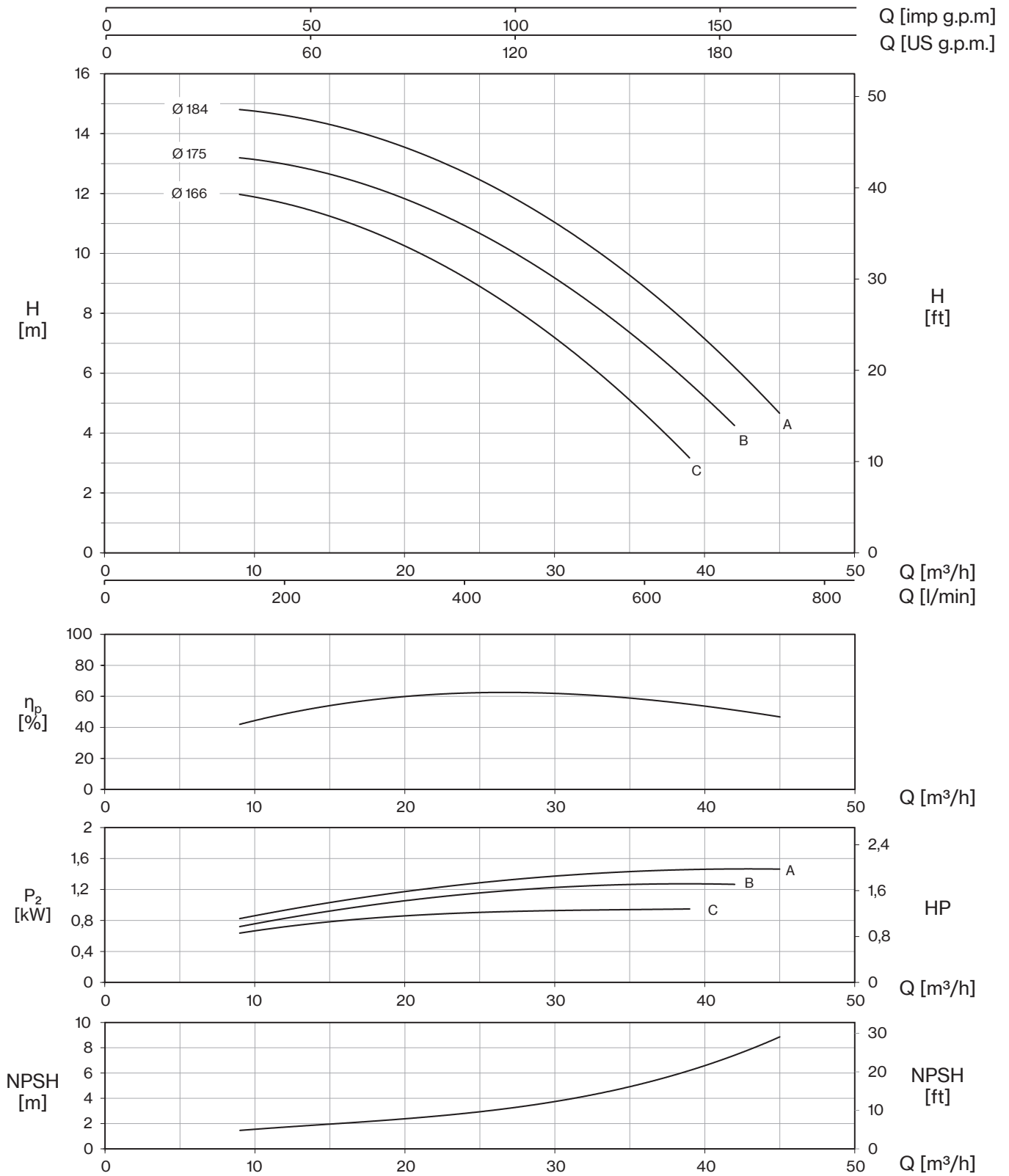

50-250

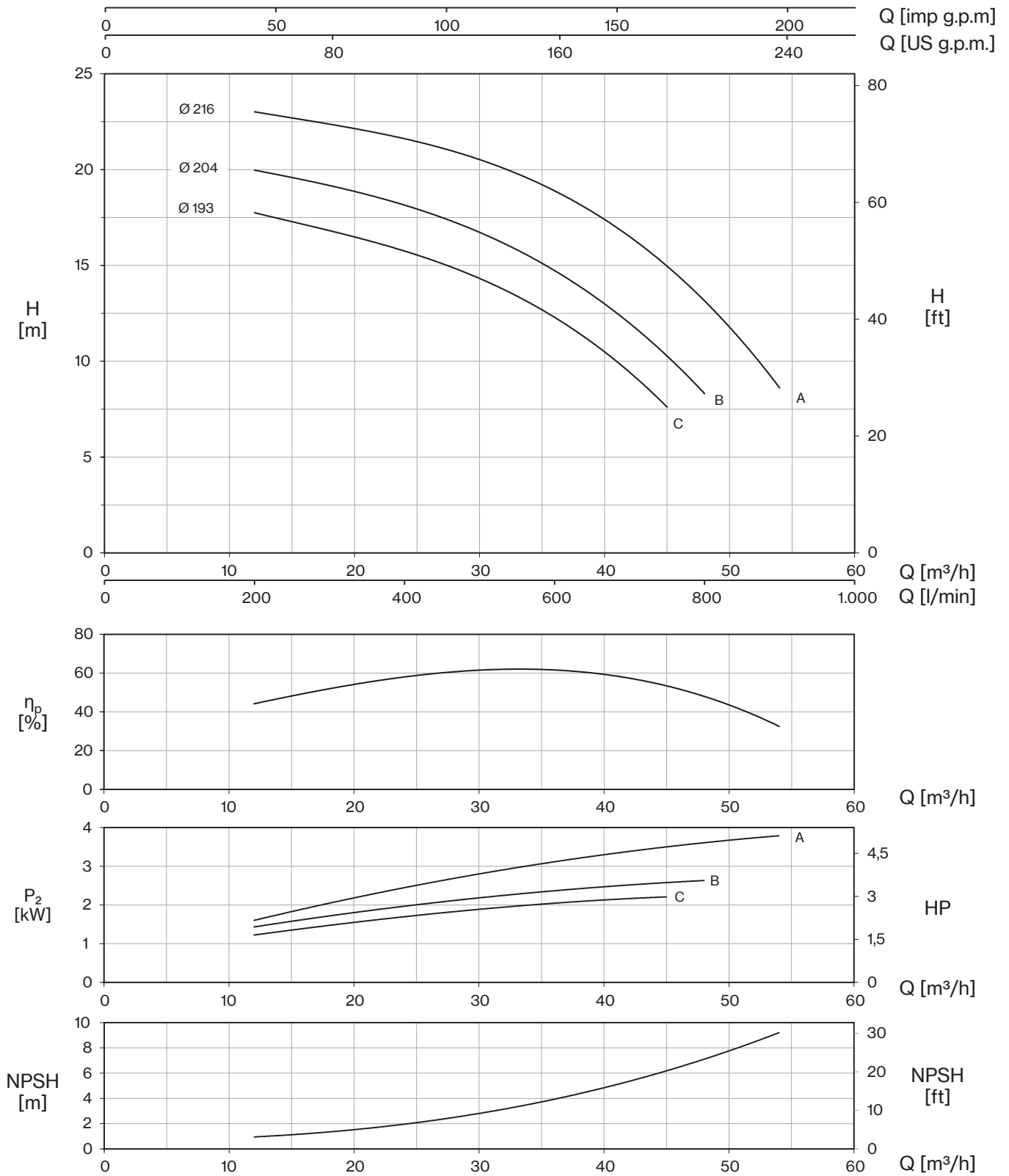

50-315

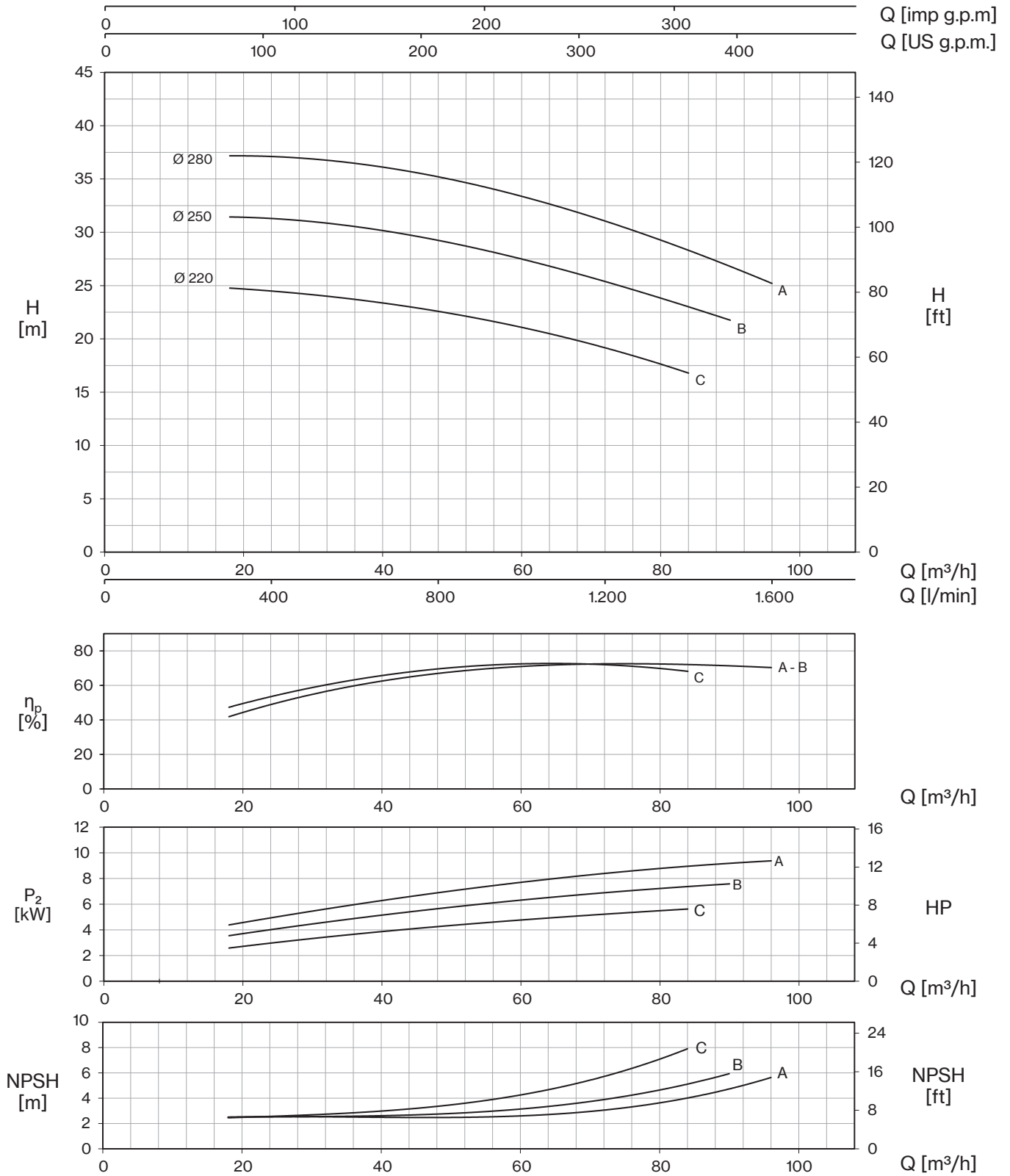

65-125

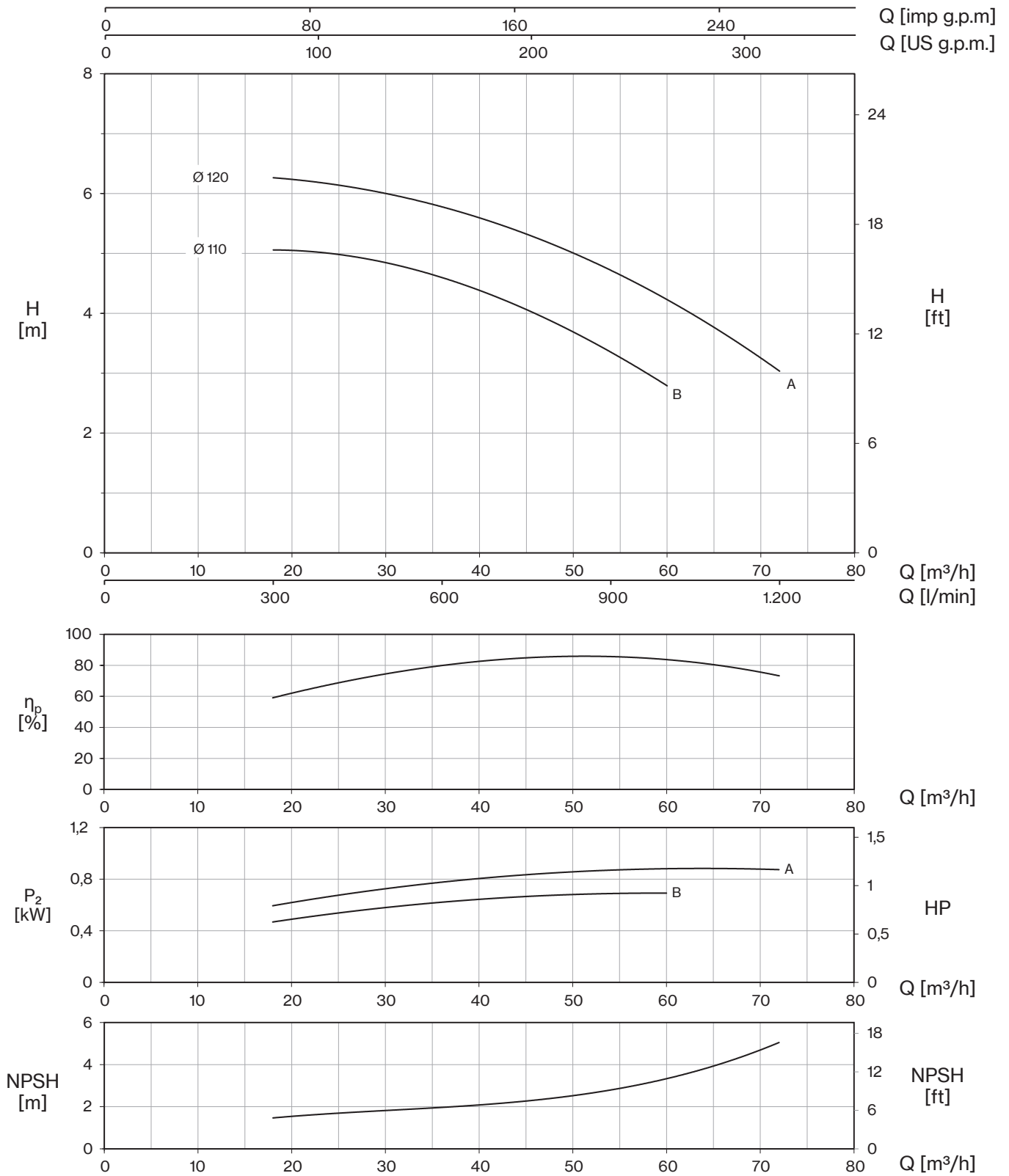

65-160

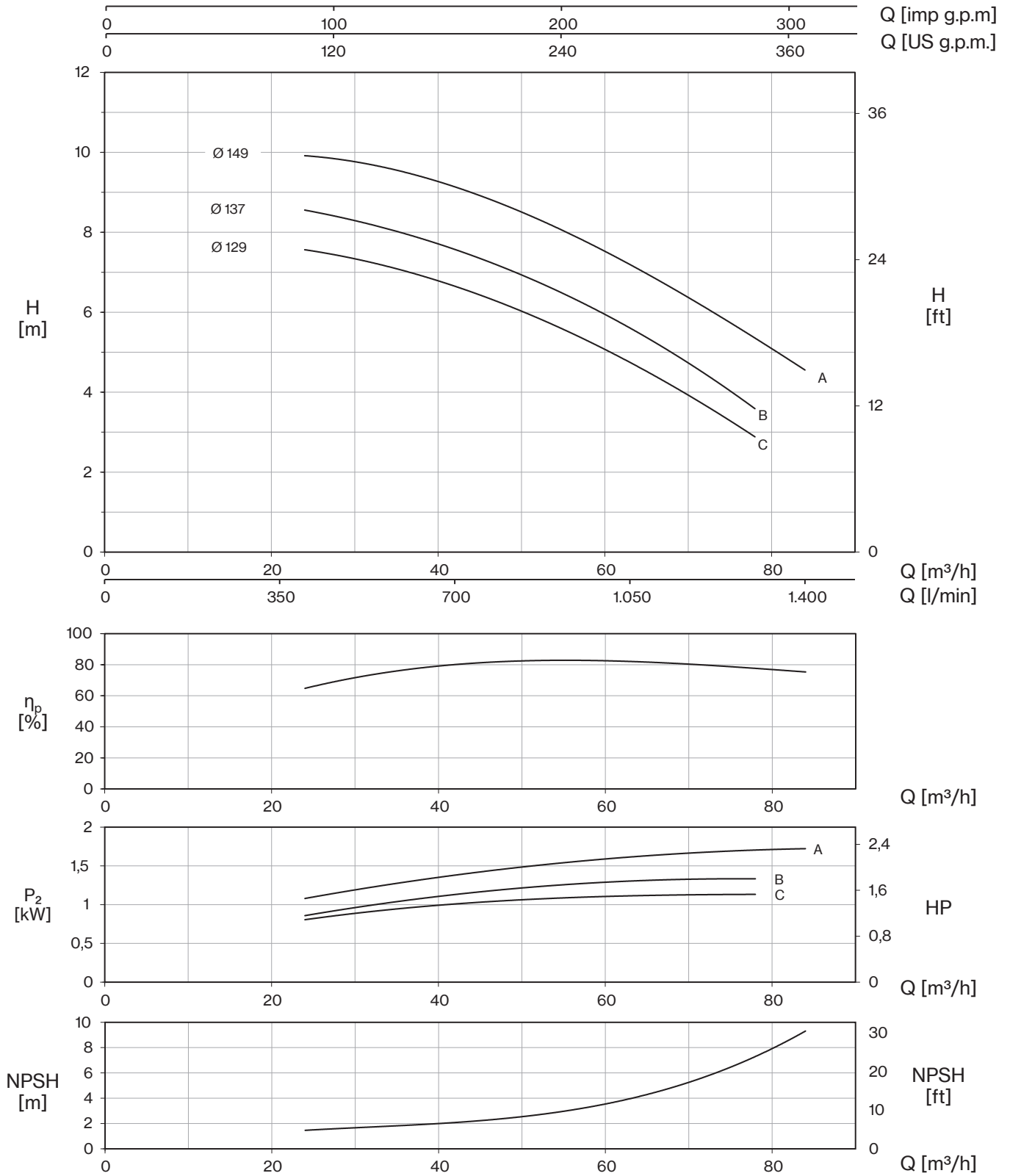

65-200

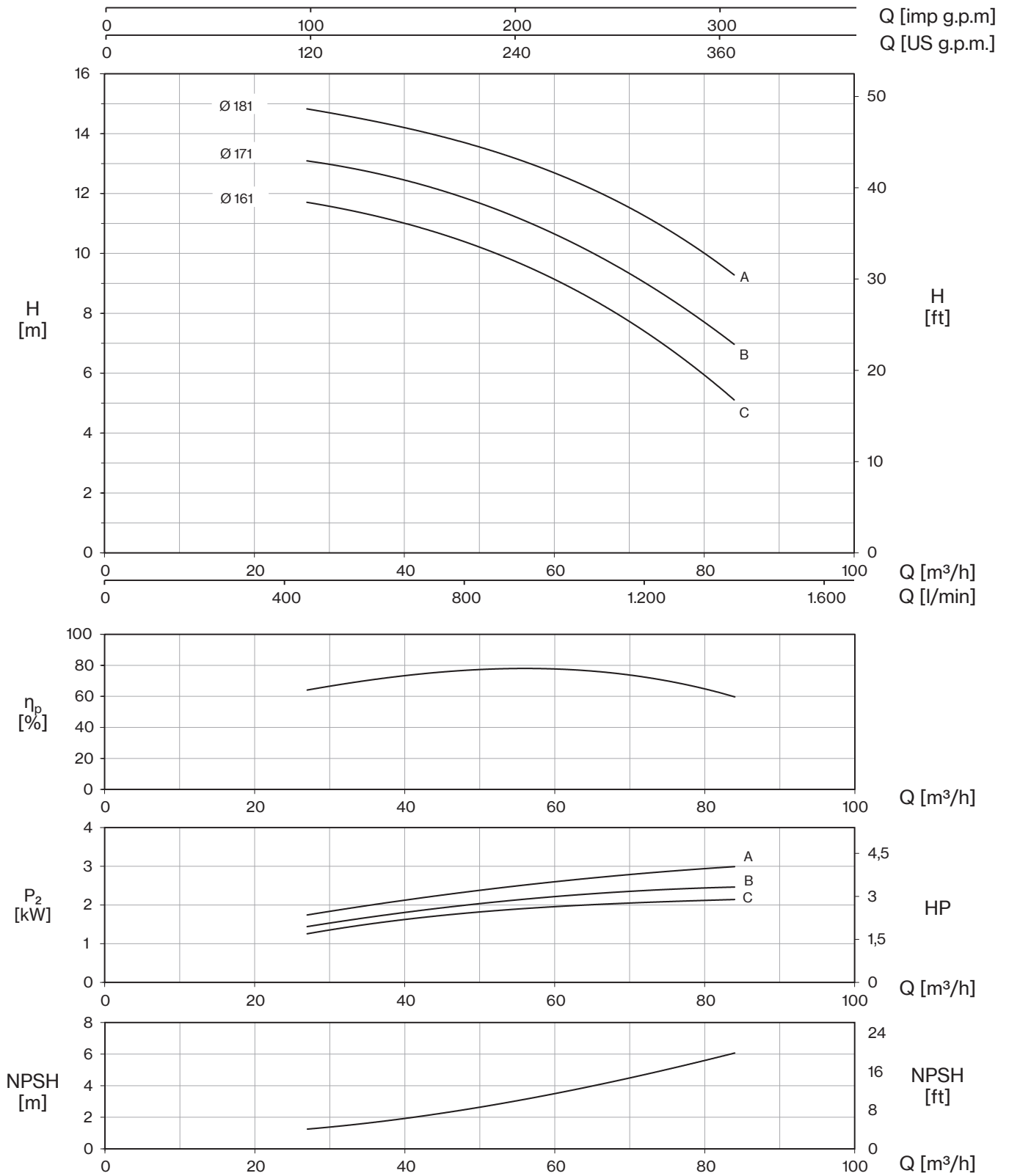

65-250

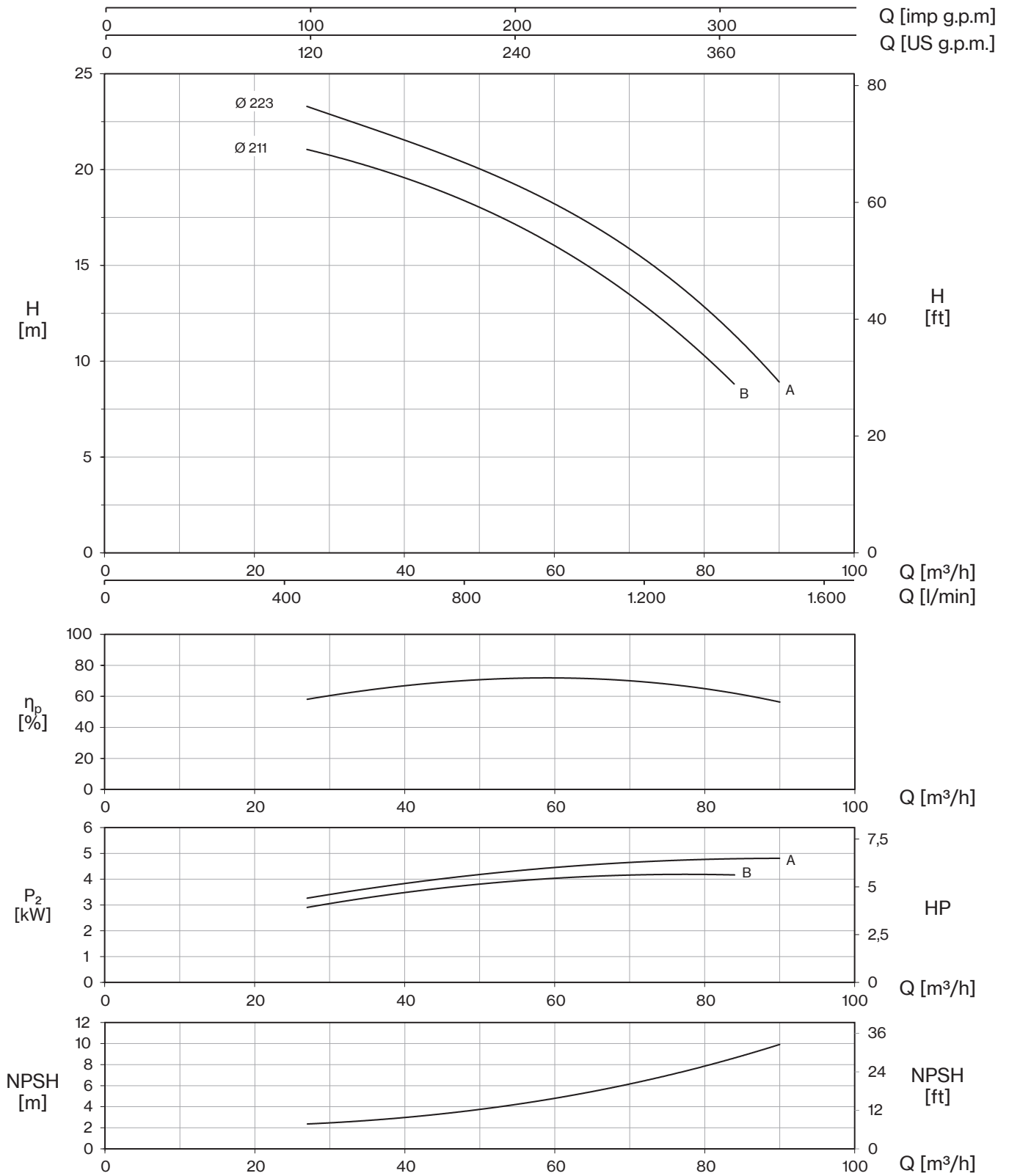

65-315

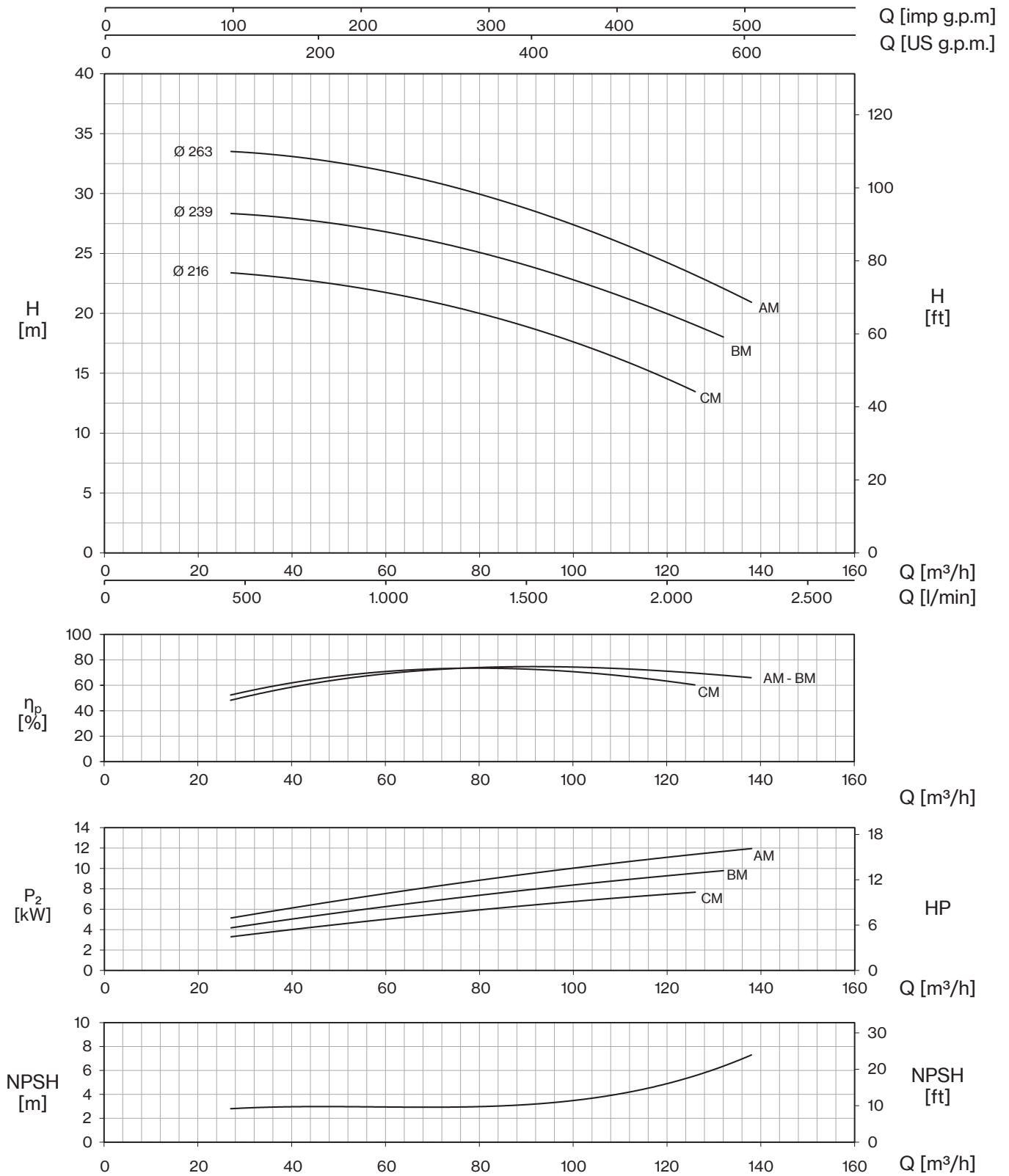

80-160

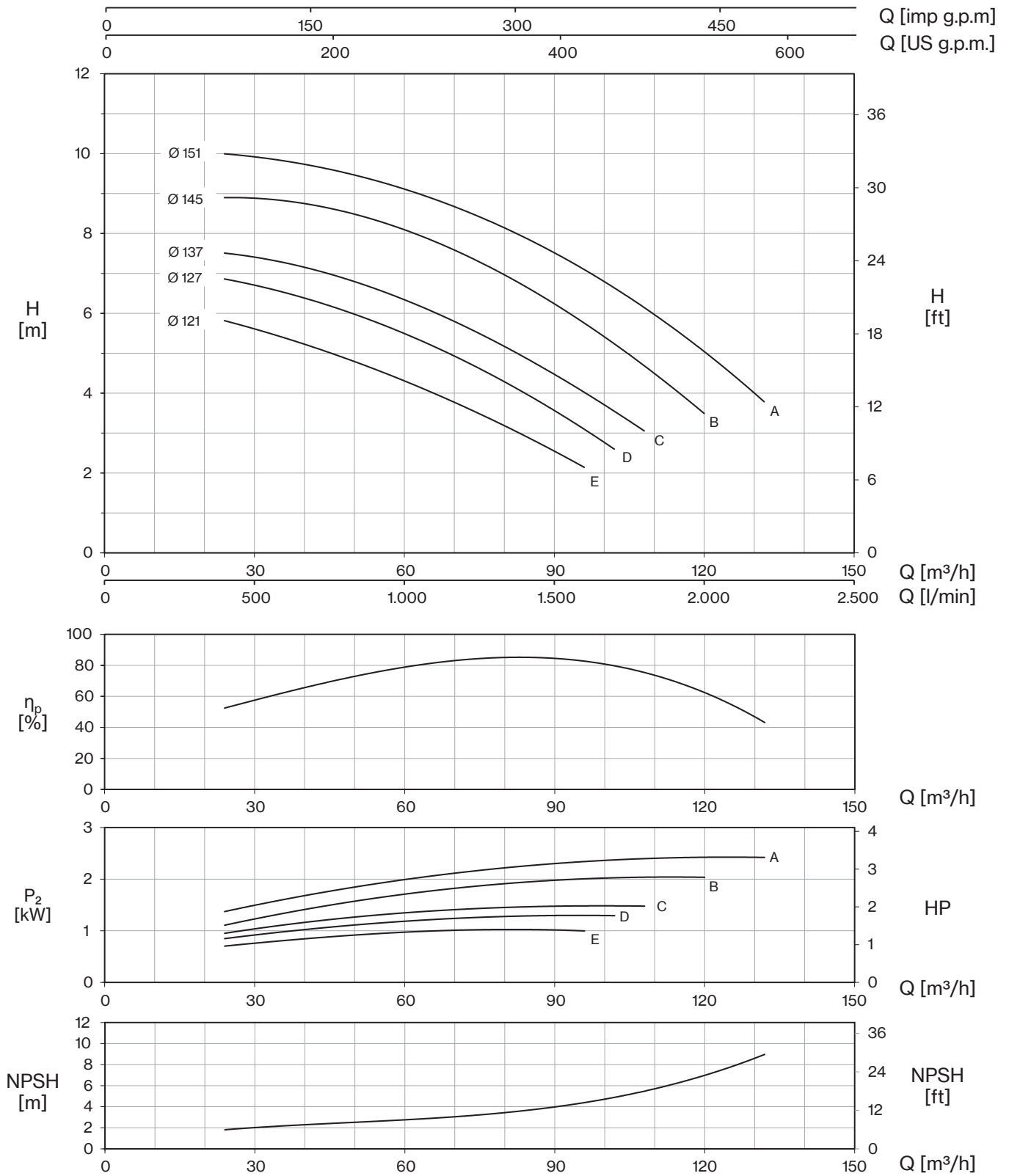

80-200

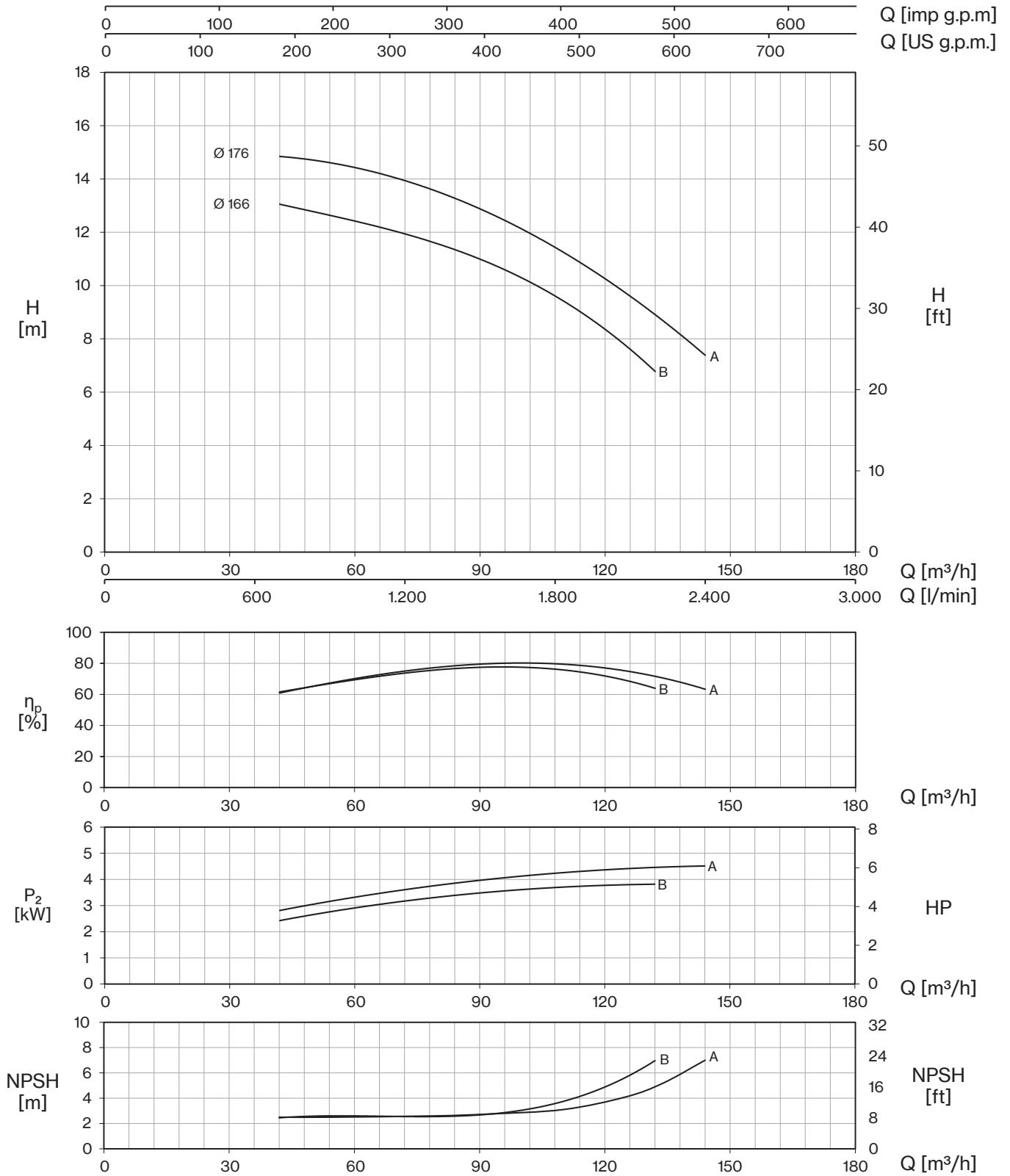

80-250

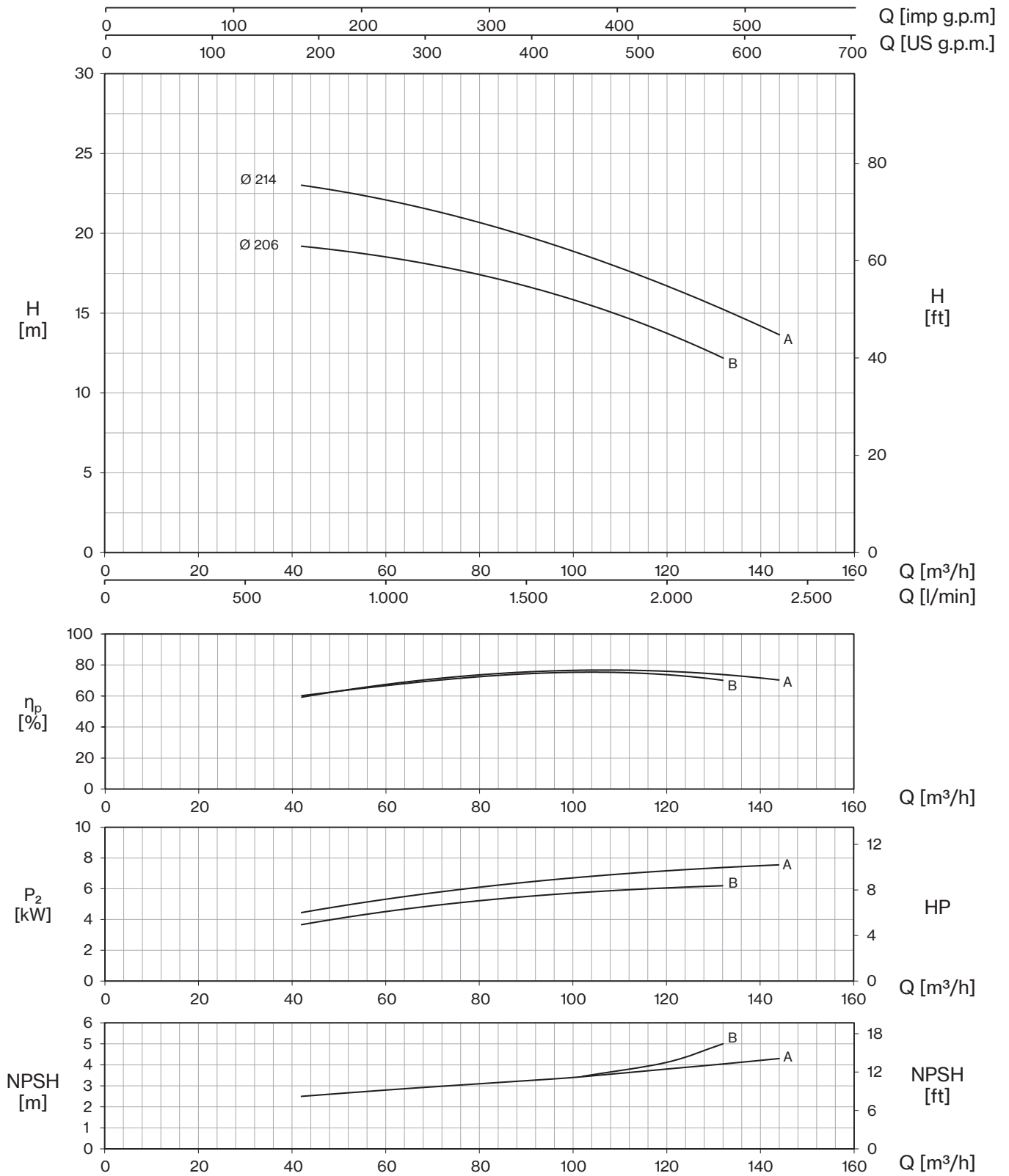

80-315

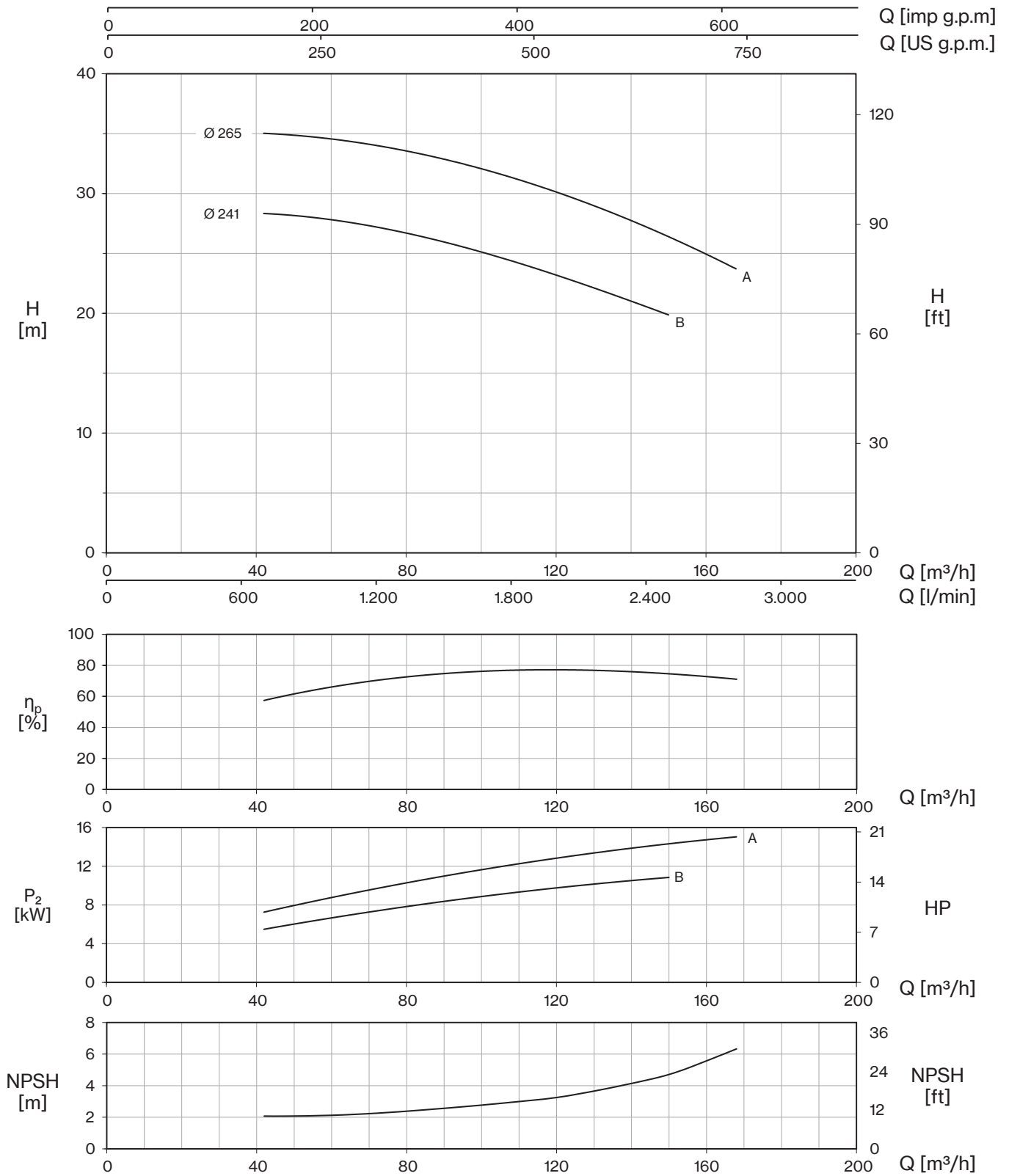

100-200

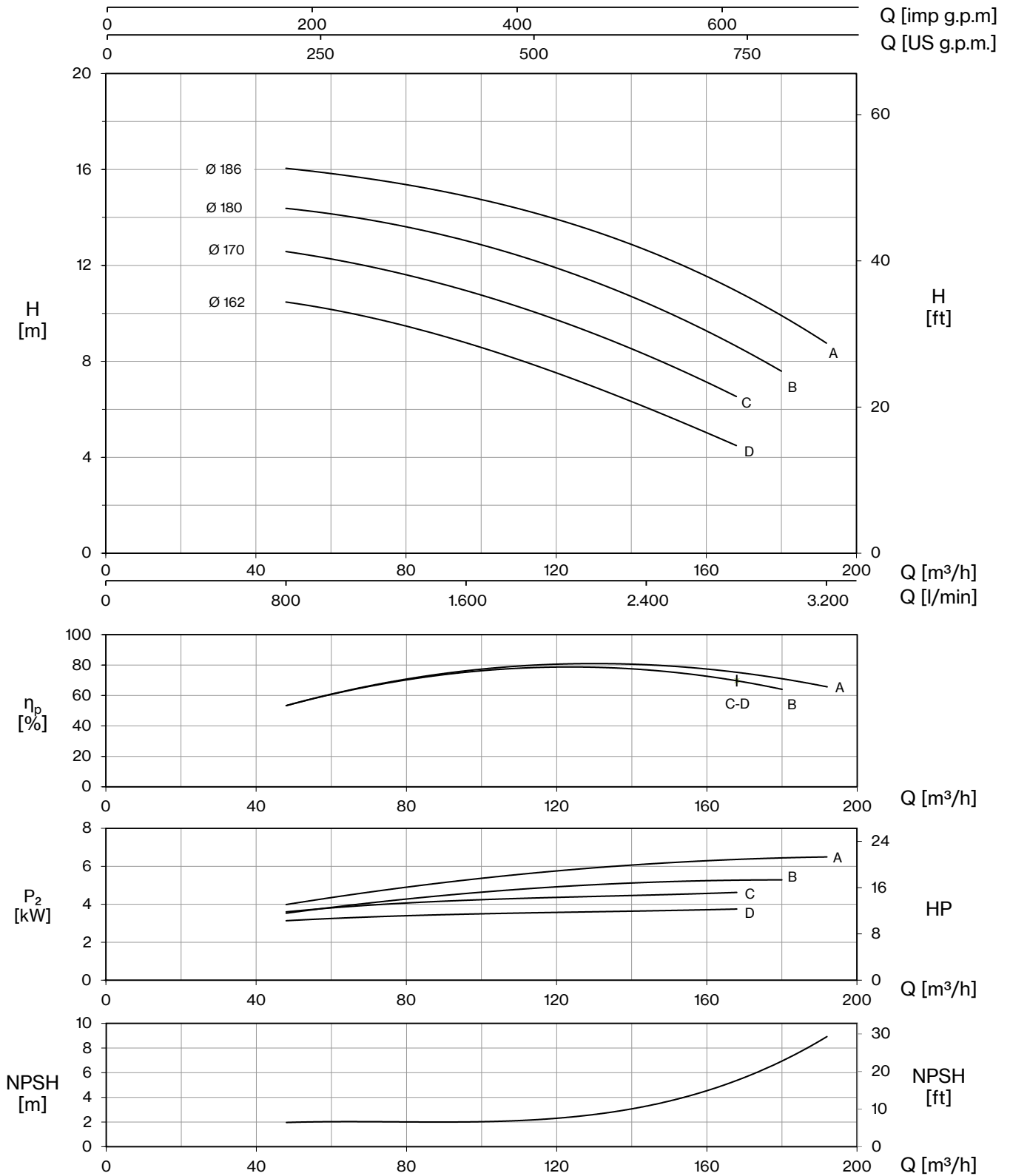

100-250

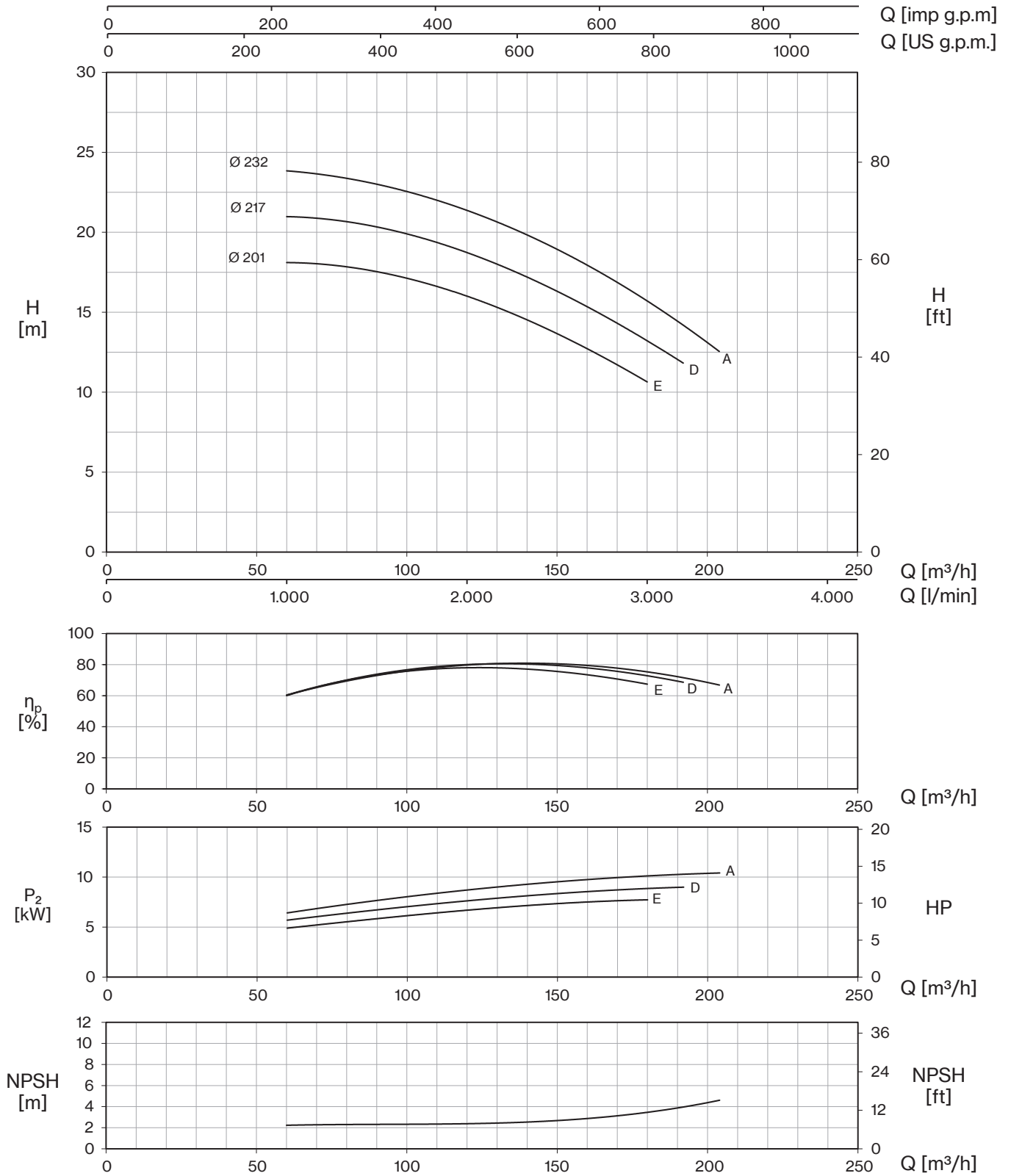

100-315

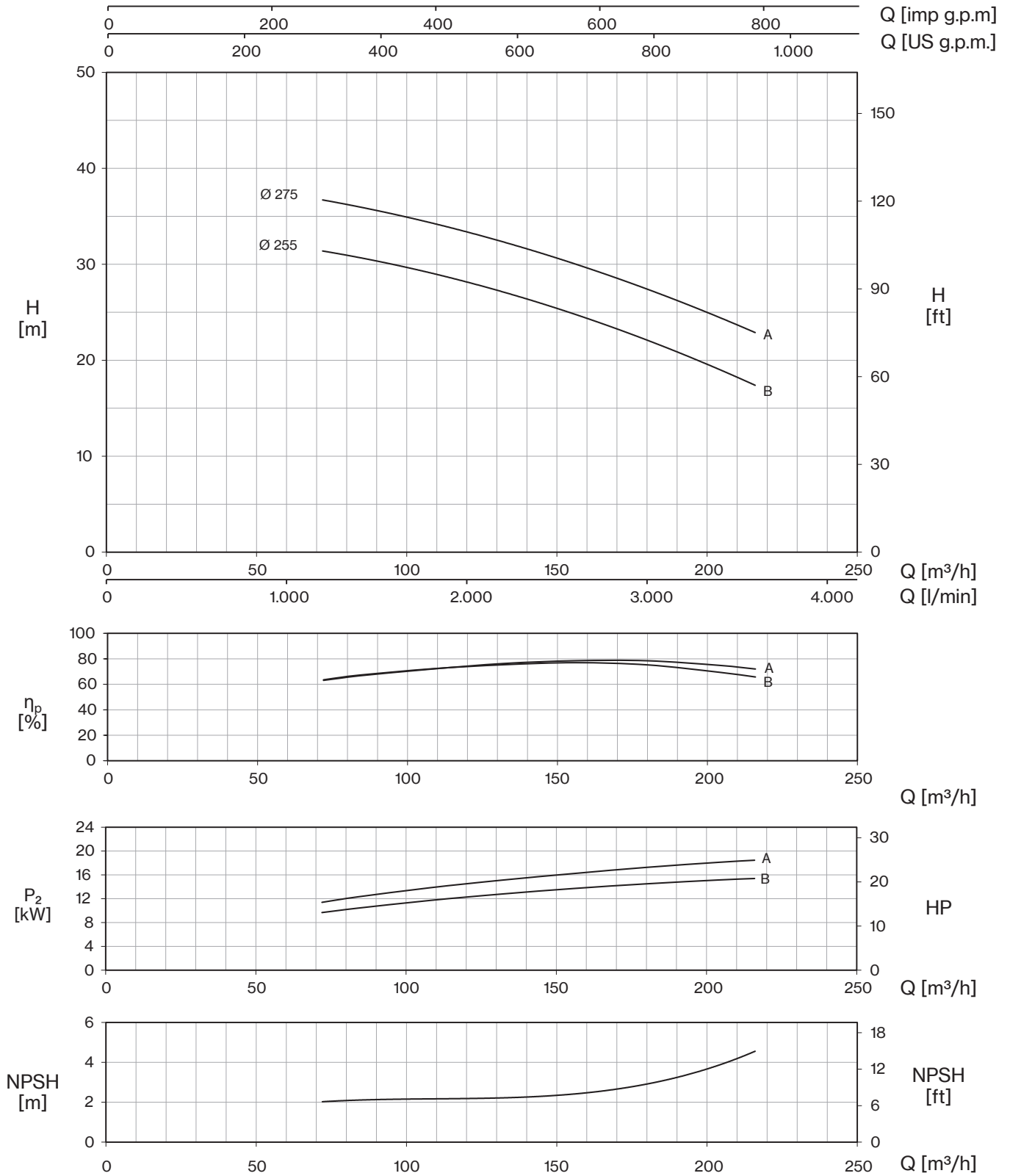

100-400

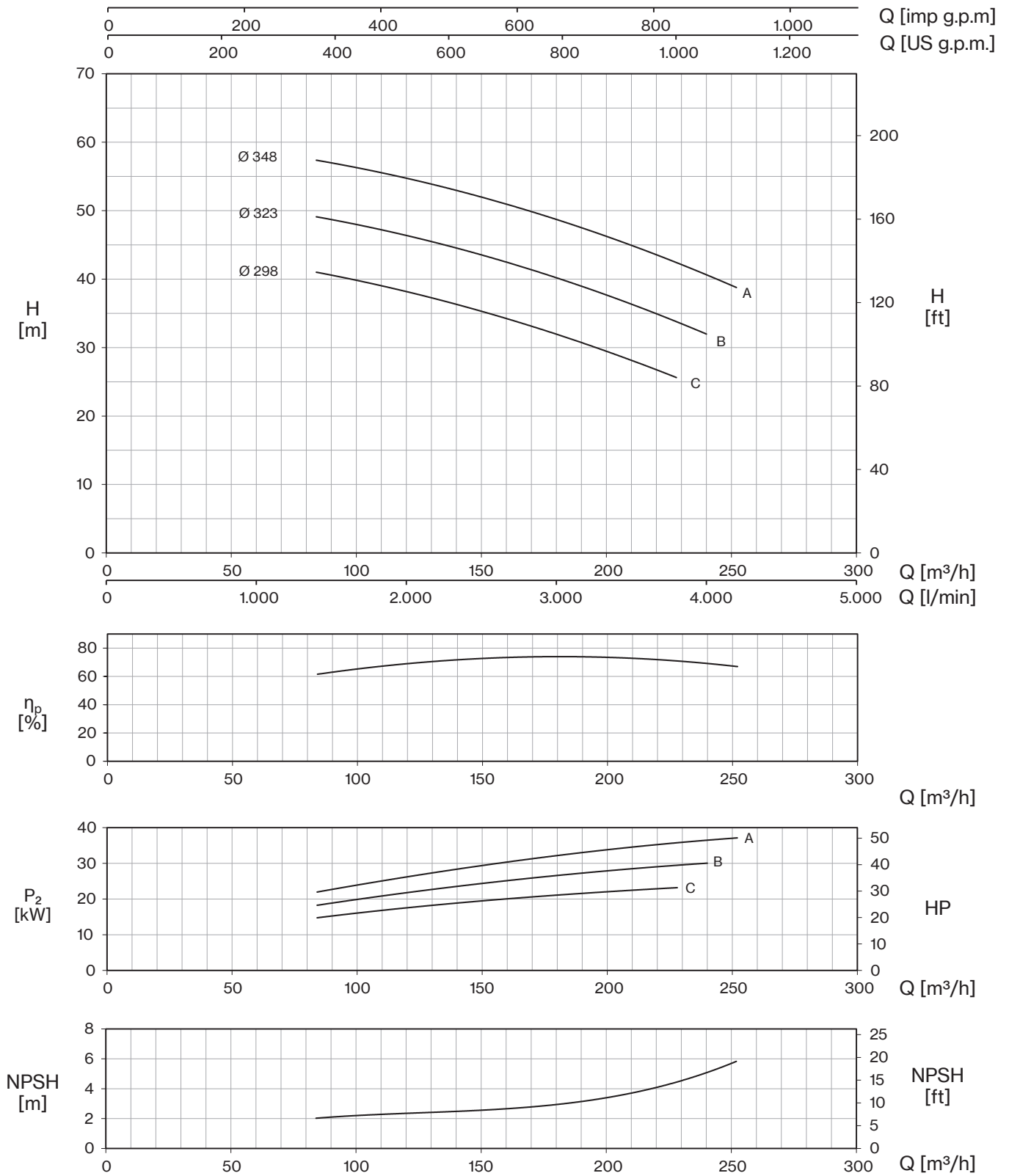

125-250

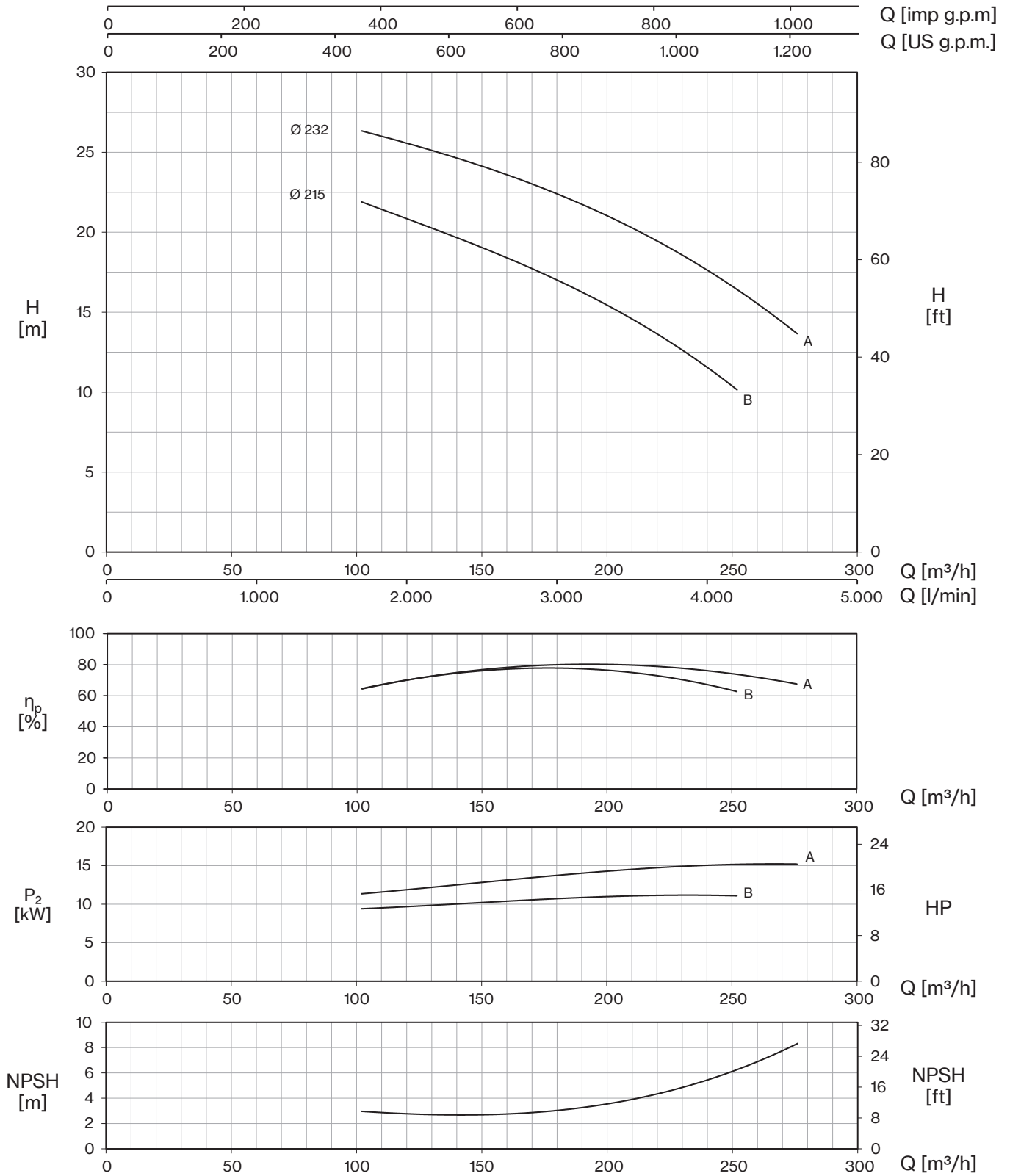

125-315

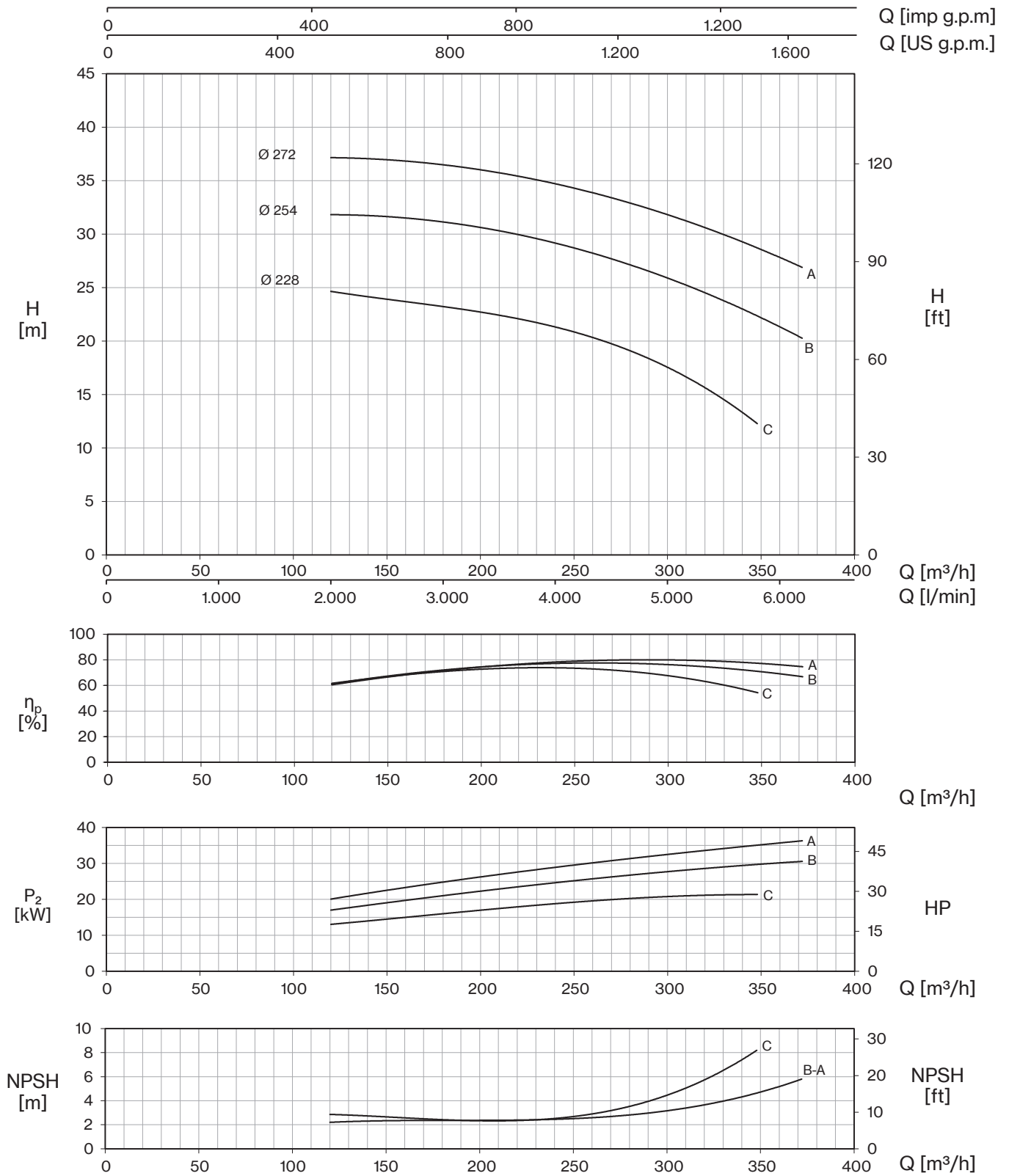

125-400

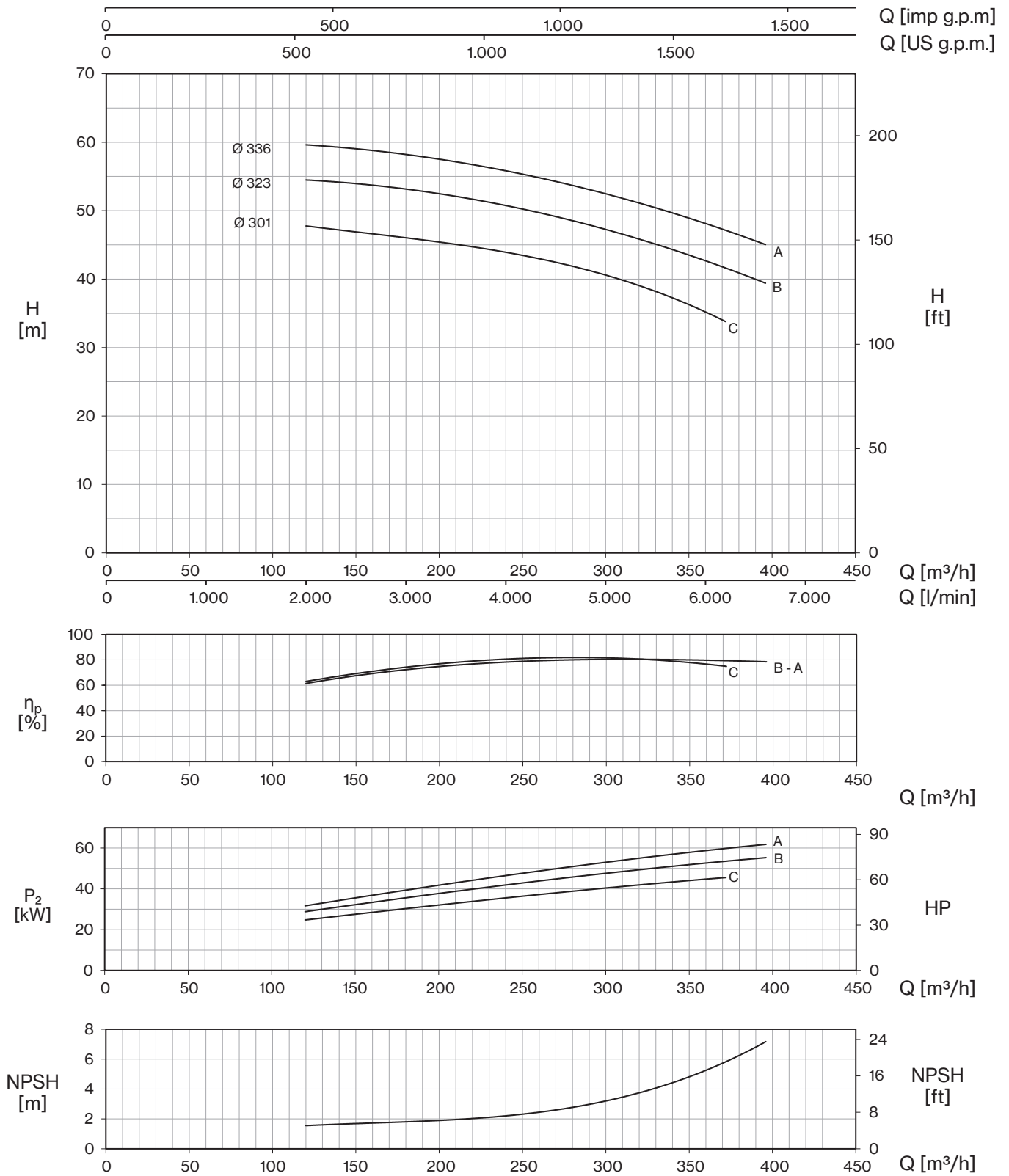

150-315

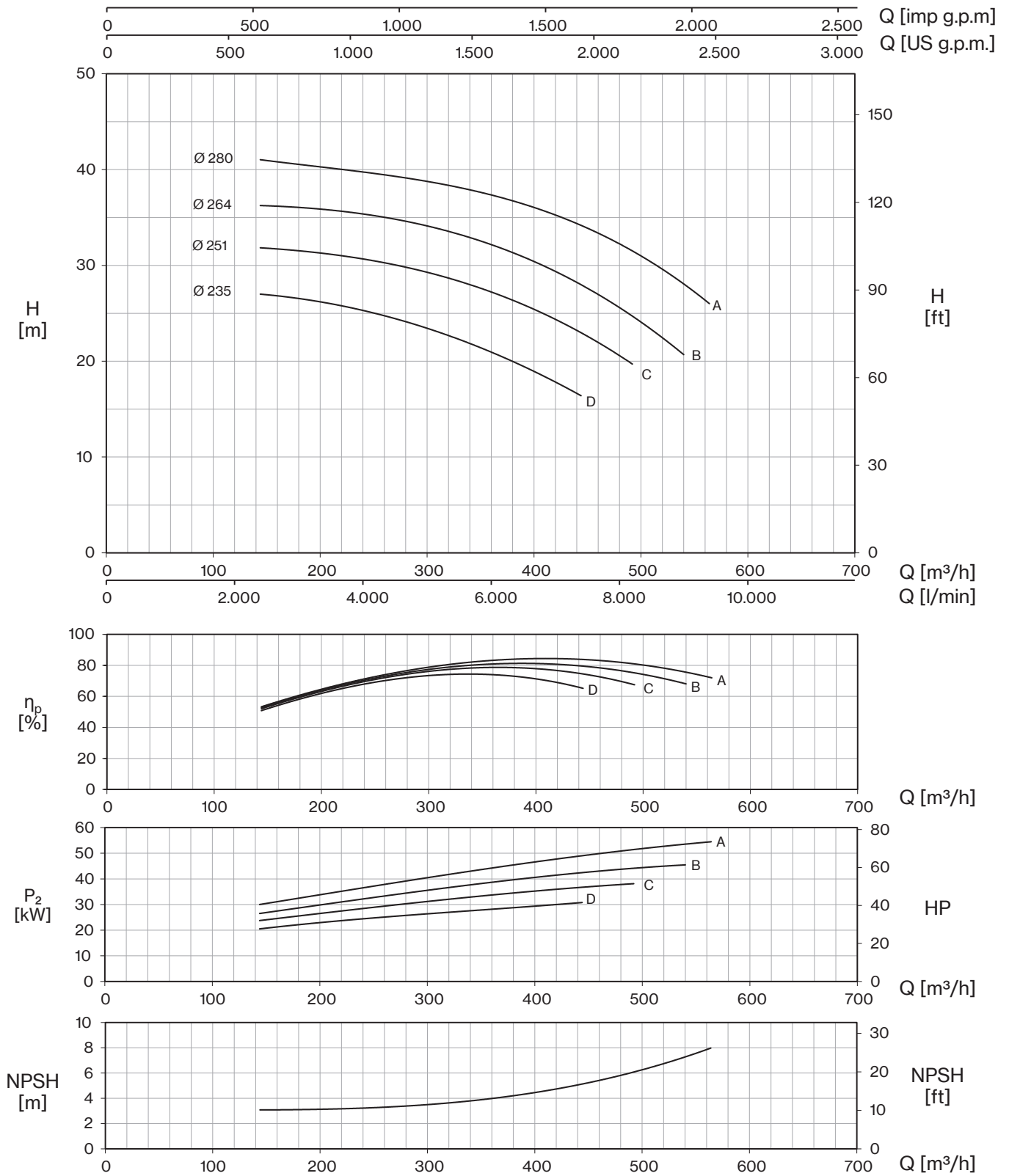

150-400

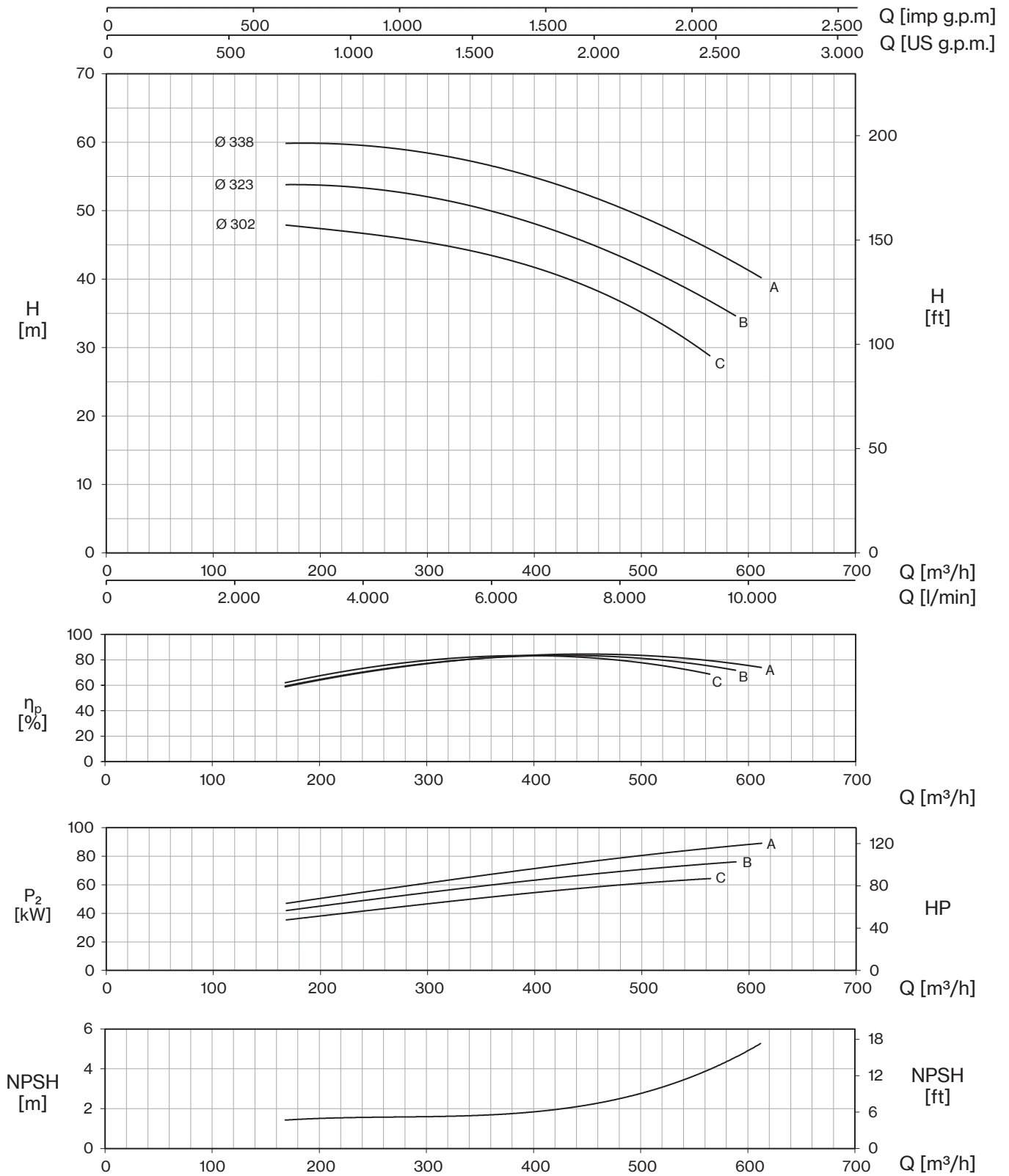

200-315

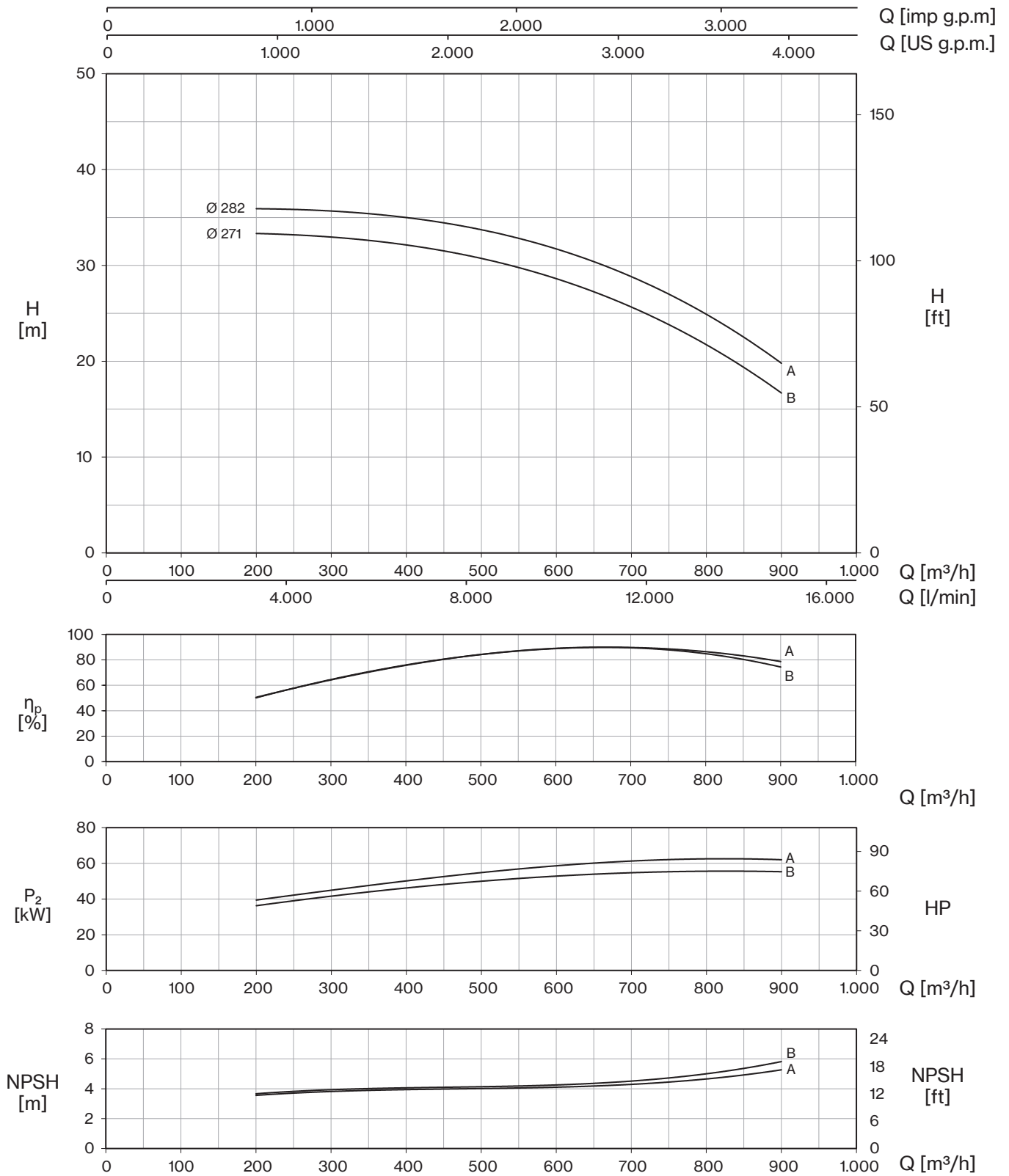

200-400

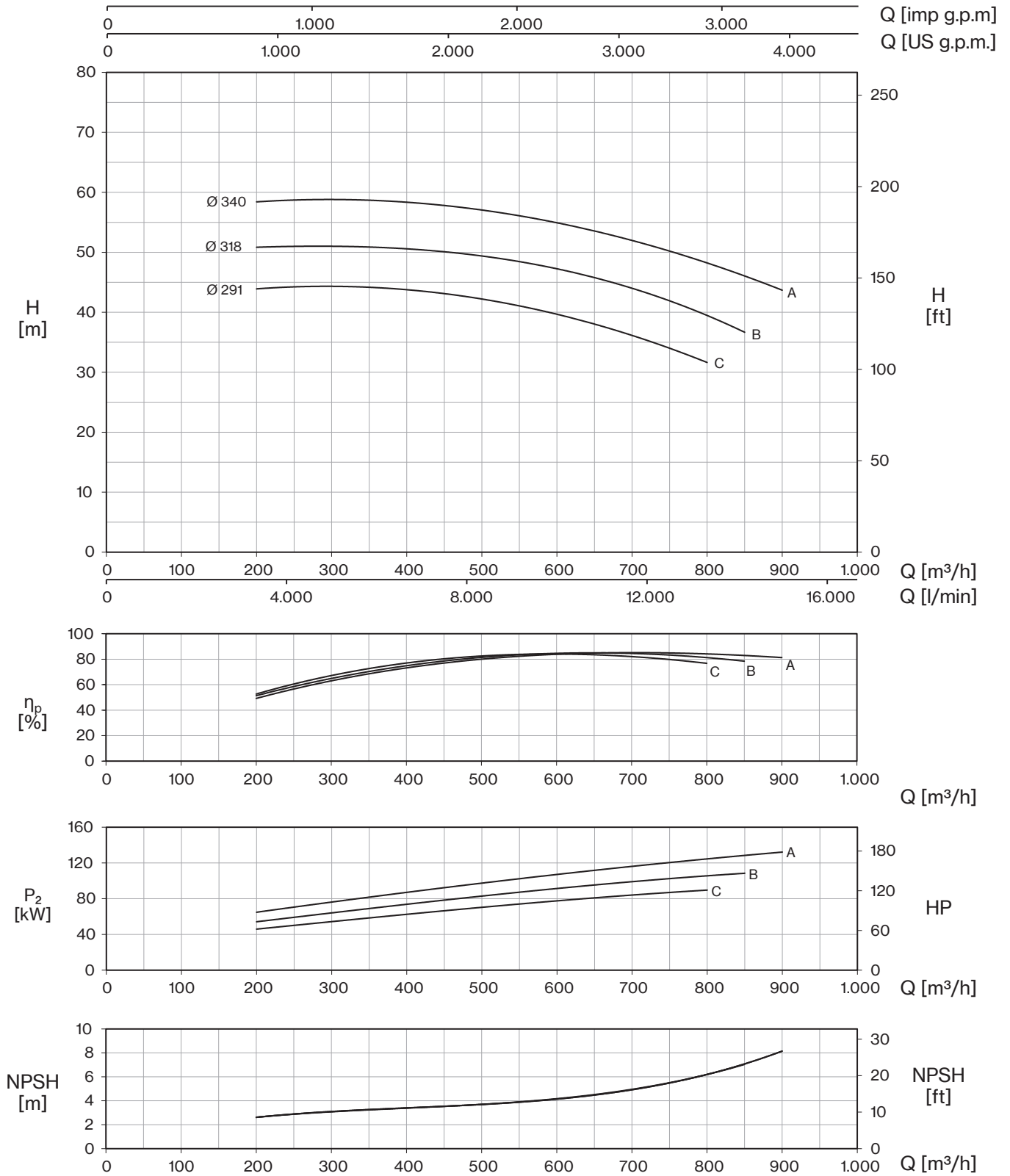

250-315

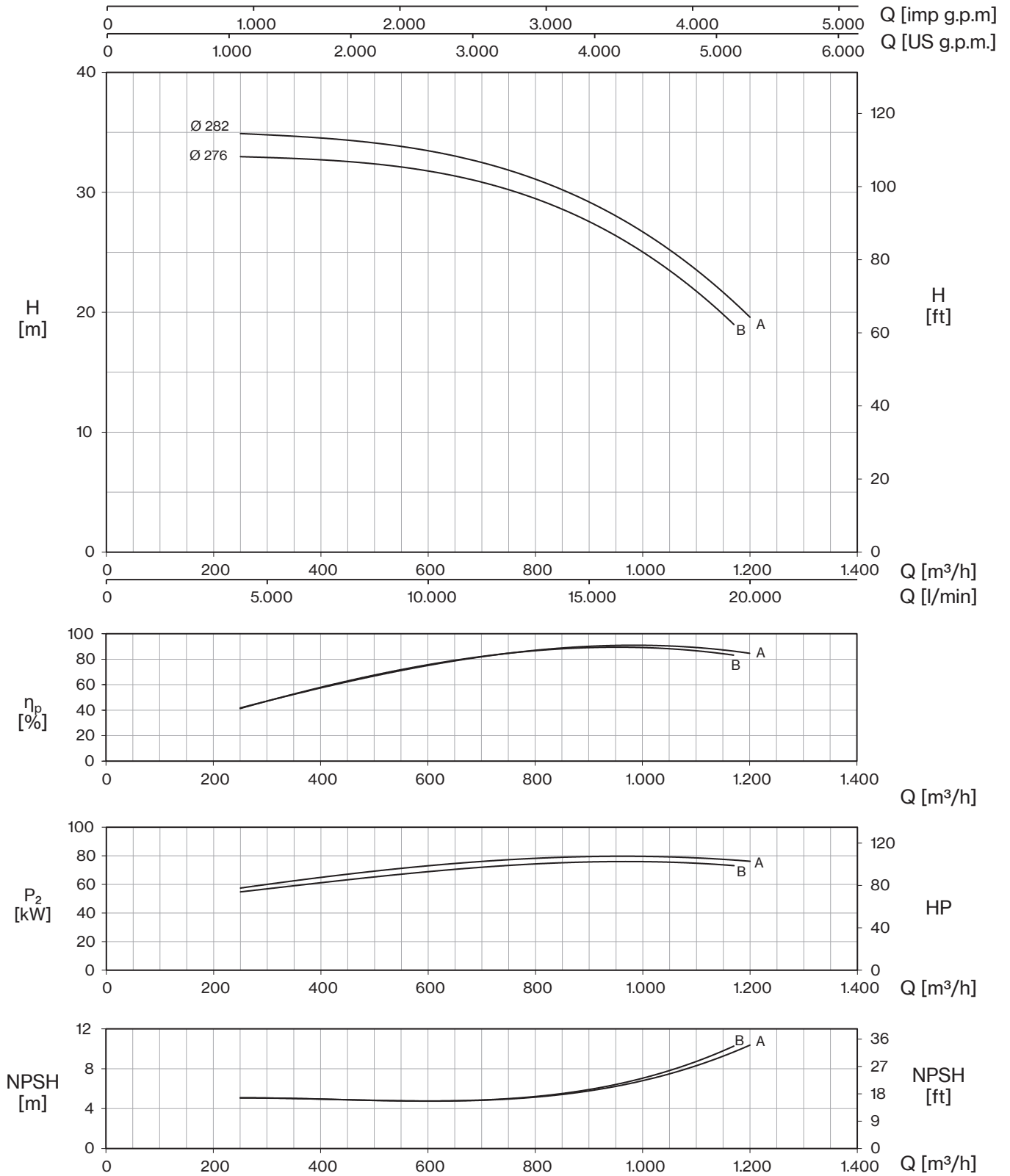

250-400

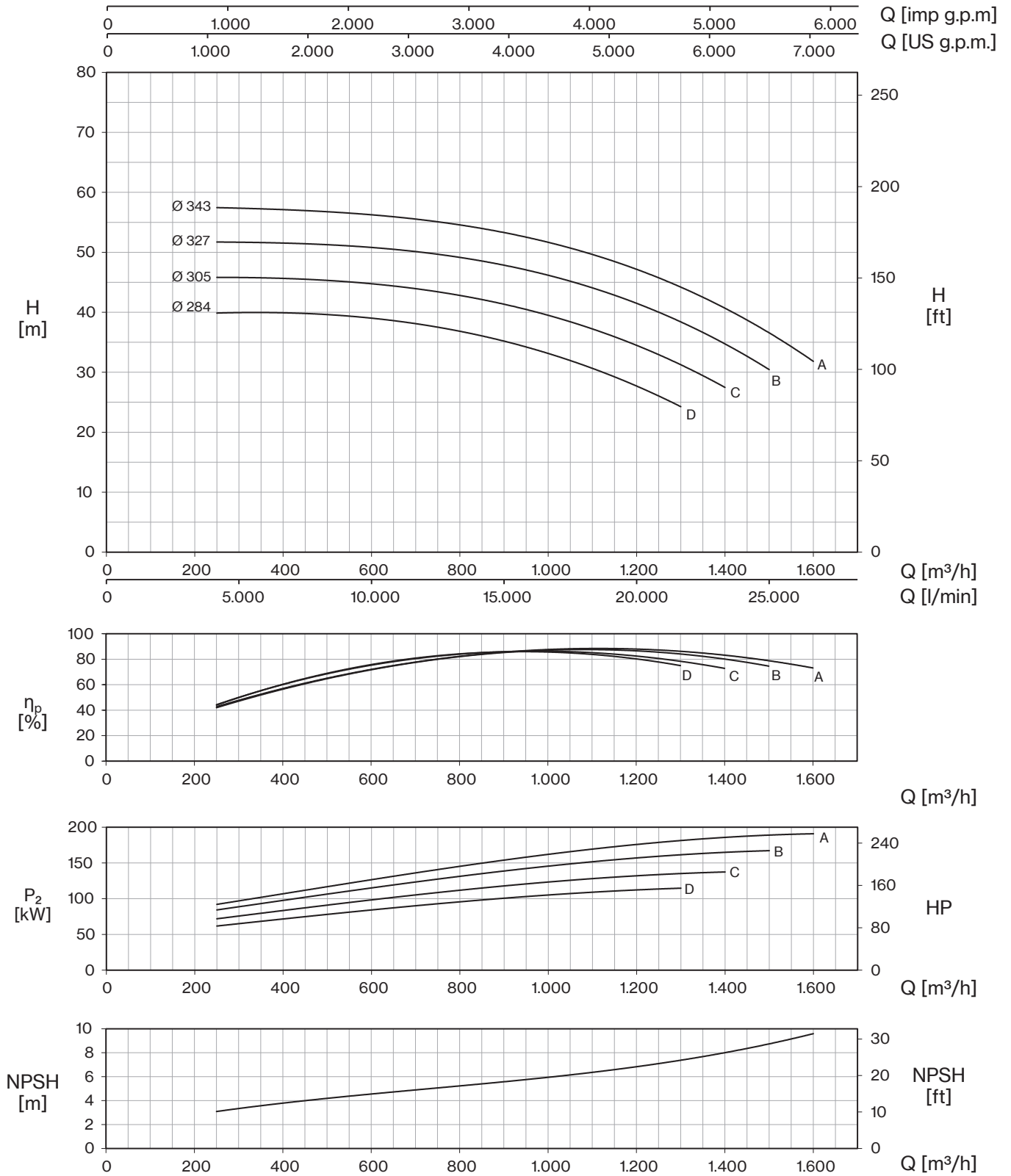

CA-CAX EN 733 ~ 3500 rpm
4CA-4CAX EN 733 ~ 1750 rpm

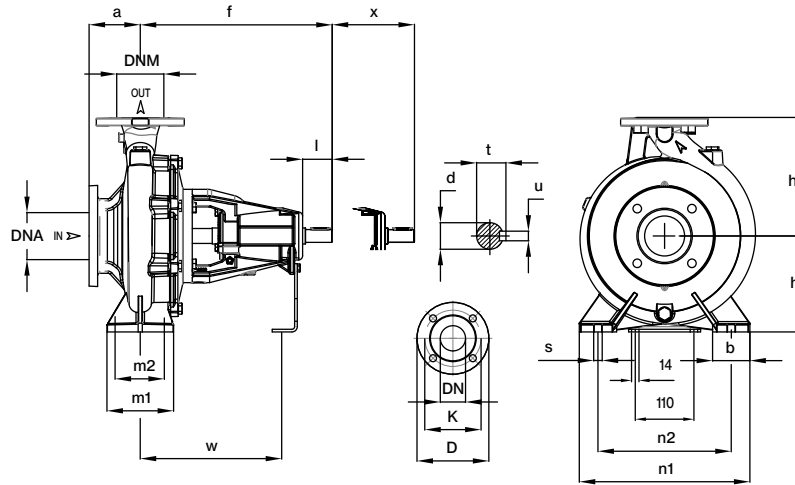

TYPE	DIMENSIONS (mm)																			Kg		
	a	f	h1	h2	m1	m2	n1	n2	s	b	l	d1	t	u	x	w	DNA	DNM	I	L	M	
32-160	80	360	132	160	100	70	240	190	14	50	50	24	27	8	100	260			535	320	445	37,5
32-200	80	360	160	180	100	70	240	190	14	50	50	24	27	8	100	260	50	32	535	320	445	40
32-250	100	360	180	225	125	95	320	250	14	65	65	24	27	8	100	260			545	405	545	48,5
40-125	80	360	112	140	100	70	210	160	14	50	50	24	27	8	100	260			535	320	445	36,5
40-160	80	360	132	160	100	70	240	190	14	50	50	24	27	8	100	260	65	40	535	320	445	38,5
40-200	100	360	160	180	100	70	265	212	14	50	50	24	27	8	100	260			535	320	445	42,5
40-250	100	360	180	225	125	95	320	250	14	65	50	24	27	8	100	260			545	405	545	47,5
50-125	100	360	132	160	100	70	240	190	14	50	50	24	27	8	100	260			535	320	445	39
50-160	100	360	160	180	100	70	265	212	14	50	50	24	27	8	100	260	65	50	535	320	445	43
50-200	100	360	160	200	100	70	265	215	14	50	50	24	27	8	100	260			535	320	445	46
50-250	100	360	180	225	125	95	320	250	14	65	50	24	27	8	100	260			545	405	545	52,5
50-315	125	470	225	280	125	95	345	280	14	65	80	32	35,3	10	100	340	80		655	465	620	93
65-125	100	360	160	180	125	95	280	212	14	65	65	24	27	8	100	260			535	320	445	44,5
65-160	100	360	160	200	125	95	280	212	14	65	65	24	27	8	100	260			535	320	445	48,5
65-200	100	360	180	225	125	95	320	250	14	65	65	24	27	8	140	260	80	65	545	405	545	53
65-250	100	470	200	250	160	120	360	280	19	80	80	32	35	10	140	340			545	405	545	76
65-315	125	470	225	280	160	120	400	315	19	80	80	32	35	10	140	340			655	465	620	99,5
80-160	125	360	180	225	125	95	320	250	14	65	50	24	27	8	140	260			545	405	545	57,5
80-200	125	470	180	250	125	95	345	280	14	65	80	32	35	10	140	340	100	80	680	405	545	73
80-250	125	470	200	280	160	120	400	315	18	80	80	32	35,3	10	140	340			655	465	585	89,5
80-315	125	470	250	315	160	120	400	315	18	80	80	32	35,3	10	140	340			655	465	620	106
100-200	125	470	200	280	160	120	360	286	18	80	80	32	35,3	10	140	340			655	465	620	95
100-250	140	470	225	280	160	120	400	315	18	80	80	32	35,3	10	140	340	125	100	655	465	620	103
100-315	140	470	250	315	160	120	400	315	18	80	80	32	35,3	10	140	340			655	465	620	122
100-400	140	530	280	355	200	150	500	400	22	100	110	42	45,3	12	140	370			720	775	855	183,5
125-250	140	470	315	355	200	150	400	315	22	100	110	32	45,3	12	140	370			655	465	620	132
125-315	140	530	280	355	200	150	500	400	22	100	110	42	45,3	12	140	370	150	125	720	775	855	169
125-400	140	530	315	400	200	150	500	400	22	100	110	42	45,3	12	140	370			720	775	855	190,5
150-315	160	530	280	400	200	150	550	450	22	100	110	42	45,3	12	140	370			655	465	620	186,5
150-400	160	530	315	450	200	150	550	450	22	100	110	42	45,3	12	140	370	200	150	720	775	855	214
200-315	180	706	355	450	250	190	634	500	28	134	110	55	58,3	16	208	523			800	1200	1150	345
200-400	180	706	355	500	250	190	634	500	28	134	110	55	58,3	16	214	523	250	200	800	1200	1150	346
250-315	225	711	400	500	250	200	694	560	28	134	110	55	58,3	16	214	523			800	1200	1070	401,5
250-400	225	706	400	550	250	200	694	560	28	134	110	55	58,3	16	220	523	300	250	800	1200	1120	393

DIMENSIONS (mm)				
DN	D	K	holes	
			n°	Ø
32	140	100	4	18
40	150	110	4	18
50	165	125	4	18
65	185	145	4	18
80	200	160	8	18
100	220	180	8	18
125	250	210	8	18
150	285	240	8	23
200	340	295	8	23
250	395	350	12	23
300	445	400	12	23

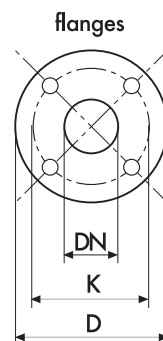

CA-CAX EN 733 ~ 3500 rpm

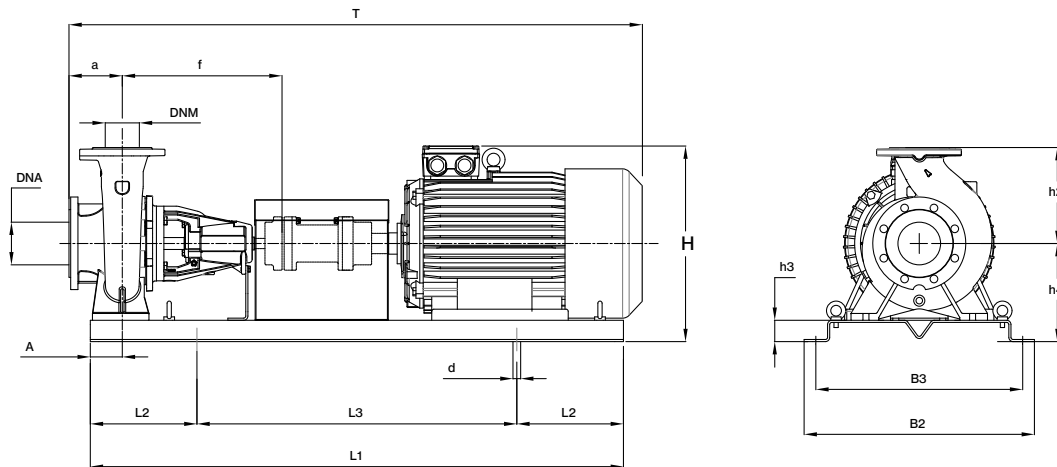

TYPE	kW	Motor Size	DIMENSIONS (mm)														Kg		
			a	f	h4	h2	h3	L1	L2	L3	B2	B3	A	d	T	H		DNA	DNM
32-160C	1,5	90S	80	360	182	160	50	900	150	600	390	350	60	18	855	342	50	32	82,1
32-160B	2,2	90L	80	360	182	160	50	900	150	600	390	350	60	18	920	342			87,7
32-160A	3	100L	80	360	182	160	50	900	150	600	390	350	60	18	920	362			96,7
32-200C	4	112M	80	360	210	180	50	900	150	600	390	350	60	18	940	403			108,7
32-200B	5,5	132S	80	360	210	180	50	1000	170	660	450	400	60	22	1020	453			116,1
32-200B	7,5	132S	80	360	210	180	50	1000	170	660	450	400	60	22	1020	433			144,3
32-200A	7,5	132S	80	360	210	180	50	1000	170	660	450	400	60	22	1020	433			144,3
32-250C	11	160M	100	360	230	225	50	1250	205	840	540	490	75	22	1275	495			207,3
32-250B	11	160M	100	360	230	225	50	1250	205	840	540	490	75	22	1275	495			207,3
32-250A	15	160M	100	360	230	225	50	1250	205	840	540	490	75	22	1275	495			219,3
40-125C	1,5	90S	80	360	162	140	50	900	150	600	390	350	60	18	855	317	65	40	82,2
40-125C	2,2	90L	80	360	162	140	50	900	150	600	390	350	60	18	920	317			87,8
40-125B	2,2	90L	80	360	162	140	50	900	150	600	390	350	60	18	920	317			87,8
40-125B	3	100L	80	360	162	140	50	900	150	600	390	350	60	18	920	342			96,8
40-125A	3	100L	80	360	162	140	50	900	150	600	390	350	60	18	920	342			96,8
40-160B	3	100L	80	360	182	160	50	900	150	600	390	350	60	18	920	362			99,8
40-160B	4	112M	80	360	182	160	50	900	150	600	390	350	60	18	940	375			107,8
40-160A	4	112M	80	360	182	160	50	900	150	600	390	350	60	18	940	375			107,8
40-160AP	5,5	132S	80	360	182	160	50	1000	170	660	450	400	60	22	1020	405			115,2
40-200B	5,5	132S	100	360	210	180	50	1000	170	660	450	400	60	22	1040	433			119,2
40-200B	7,5	132S	100	360	210	180	50	1000	170	660	450	400	60	22	1040	433	147,4		
40-200A	7,5	132S	100	360	210	180	50	1000	170	660	450	400	60	22	1040	433	147,4		
40-200A	11	160M	100	360	210	180	50	1120	190	740	490	440	60	22	1168	503	198,4		
40-200AP	11	160M	100	360	210	180	50	1120	190	740	490	440	60	22	1168	475	198,4		
40-250C	11	160M	100	360	230	225	50	1250	205	840	540	490	75	22	1275	523	208,9		
40-250B	11	160M	100	360	230	225	50	1250	205	840	540	490	75	22	1275	495	208,9		
40-250A	15	160M	100	360	230	225	50	1250	205	840	540	490	75	22	1275	495	220,9		
40-250BM	18,5	160L	100	360	230	225	50	1250	205	840	540	490	75	22	1275	495	238,9		
40-250AM	22	180M	100	360	230	225	50	1250	205	840	540	490	75	22	1275	530	297,3		
50-125B	3	100L	100	360	182	160	50	900	150	600	390	350	60	18	940	342	65	50	99,7
50-125A	4	112M	100	360	182	160	50	900	150	600	390	350	60	18	960	342			107,7
50-160B	5,5	132S	100	360	210	180	50	1000	170	660	450	400	60	22	1040	405			119,6
50-160A	7,5	132S	100	360	210	180	50	1000	170	660	450	400	60	22	1040	390			147,8
50-200C	11	160M	100	360	210	200	50	1120	190	740	490	440	60	22	1168	535			201,8
50-200B	11	160M	100	360	210	200	50	1120	190	740	490	440	60	22	1168	523			201,8
50-200A	15	160M	100	360	210	200	50	1120	190	740	490	440	60	22	1168	503			213,8
50-250C	15	160M	100	360	230	225	50	1250	205	840	540	490	75	22	1275	523			224,8
50-250B	18,5	160L	100	360	230	225	50	1250	205	840	540	490	75	22	1275	495			242,8
50-250A	22	180M	100	360	230	225	50	1250	205	840	540	490	75	22	1275	530			301,2
50-315DN	37	200L	125	470	275	280	50	1400	230	940	610	550	75	26	1455	625	80	415,0	
50-315CN	45	225M	125	470	275	280	50	1400	230	940	610	550	75	26	1500	670		465,8	
50-315BN	55	250M	125	470	310	280	85	1600	270	1060	660	600	75	26	1650	800		611,8	
50-315AN	75	280S	125	470	310	280	85	1800	300	1200	730	670	75	26	1850	870		762,6	



TYPE	kW	Motor Size	DIMENSIONS (mm)															Kg	
			a	f	h4	h2	h3	L1	L2	L3	B2	B3	A	d	T	H	DNA		DNM
65-125B	5,5	132S	100	360	210	180	50	1000	170	660	450	400	60	22	1040	390	80	65	121,4
65-125B	7,5	132S	100	360	210	180	50	1000	170	660	450	400	60	22	1040	390			149,6
65-125A	7,5	132S	100	360	210	180	50	1000	170	660	450	400	60	22	1040	390			149,6
65-160C	11	160M	100	360	210	200	50	1120	190	740	490	440	60	22	1168	410			205,1
65-160B	11	160M	100	360	210	200	50	1120	190	740	490	440	60	22	1168	503			205,1
65-160A	15	160M	100	360	210	200	50	1120	190	740	490	440	60	22	1168	503			217,1
65-200C	15	160M	100	360	230	225	50	1250	205	840	540	490	75	22	1275	495			227,5
65-200B	18,5	160L	100	360	230	225	50	1250	205	840	540	490	75	22	1275	495			245,5
65-200B	22	180M	100	360	230	225	50	1250	205	840	540	490	75	22	1290	530			303,3
65-200A	22	180M	100	360	230	225	50	1250	205	840	540	490	75	22	1290	530			303,3
65-250B	30	200L	100	470	250	250	50	1400	230	940	610	550	90	26	1470	600			377,8
65-250A	37	200L	100	470	250	250	50	1400	230	940	610	550	90	26	1470	580			397,8
65-315CN	55	250M	125	470	310	280	85	1600	270	1060	660	600	90	26	1645	760			614,2
65-315BN	75	280S	125	470	310	280	85	1800	300	1200	730	670	90	26	1835	850			765,0
65-315AN	90	280M	125	470	310	280	85	1800	300	1200	730	670	90	26	1835	800			839,2
80-160E	11	160M	125	360	230	225	50	1250	205	840	540	490	75	22	1300	455			100
80-160D	11	160M	125	360	230	225	50	1250	205	840	540	490	75	22	1300	455	220,8		
80-160C	15	160M	125	360	230	225	50	1250	205	840	540	490	75	22	1300	495	232,8		
80-160B	18,5	160L	125	360	230	225	50	1250	205	840	540	490	75	22	1300	495	250,8		
80-160A	22	180M	125	360	230	225	50	1250	205	840	540	490	75	22	1315	530	308,7		
80-200B	30	200L	125	470	230	250	50	1400	230	940	610	550	75	26	1495	600	376,7		
80-200A	37	200L	125	470	230	250	50	1400	230	940	610	550	75	26	1495	580	396,7		
80-250B	45	225M	125	470	250	280	50	1400	230	940	610	550	90	26	1540	630	464,5		
80-250A	55	250M	125	470	285	280	85	1600	270	1060	660	600	90	26	1645	760	610,5		
100-200D	30	200L	125	470	250	280	50	1400	230	940	610	550	90	26	1500	560	125	100	374
100-200C	37	200L	125	470	250	280	50	1400	230	940	610	550	90	26	1500	560			428
100-200B	45	225M	125	470	250	280	50	1400	230	940	610	550	90	26	1540	605			471,5
100-200A	55	250M	125	470	285	280	85	1600	270	1060	660	600	90	26	1645	710			617,5
100-250C	55	250M	140	470	310	280	85	1600	270	1060	660	600	90	26	1660	680			625,5
100-250C	75	280S	140	470	310	280	85	1800	300	1200	730	670	90	26	1850	735			776,3
100-250B	75	280S	140	470	310	280	85	1800	300	1200	730	670	90	26	1850	825			776,3
100-250A	90	280M	140	470	310	280	85	1800	300	1200	730	670	90	26	1850	800			850,5

4CA-4CAX EN 733 ~ 1750 rpm

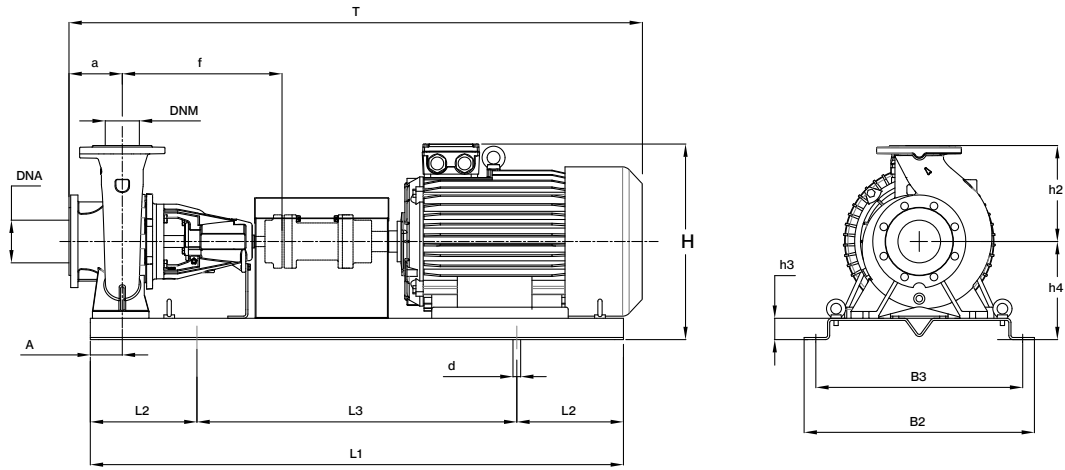

TYPE	kW	Motor Size	DIMENSIONS (mm)															Kg	
			a	f	h4	h2	h3	L1	L2	L3	B2	B3	A	d	T	H	DNA		DNM
32-160C	0,37	71M	80	360	182	160	50	800	130	540	360	320	60	18	820	342	50	32	59,4
32-160B	0,37	71M	80	360	182	160	50	800	130	540	360	320	60	18	820	342			59,4
32-160A	0,55	80M	80	360	182	160	50	800	130	540	360	320	60	18	820	342	50	32	59,1
32-200C	0,75	80M	80	360	210	180	50	800	130	540	360	320	60	18	820	390			75,1
32-200B	1,1	90S	80	360	210	180	50	800	130	540	360	320	60	18	855	390	50	32	88,1
32-200A	1,1	90S	80	360	210	180	50	800	130	540	360	320	60	18	855	390			88,1
32-250C	1,5	90S	100	360	230	225	50	1000	170	660	450	400	75	22	1025	455	50	32	106,7
32-250B	1,5	90S	100	360	230	225	50	1000	170	660	450	400	75	22	1025	455			106,7
32-250A	2,2	100L	100	360	230	225	50	1000	170	660	450	400	75	22	1025	455	50	32	112,7
40-125C	0,37	71M	80	360	162	140	50	800	130	540	360	320	60	18	820	302			65
40-125B	0,37	71M	80	360	162	140	50	800	130	540	360	320	60	18	820	302	59,5		
40-125A	0,55	80M	80	360	162	140	50	800	130	540	360	320	60	18	820	307	65	40	59,2
40-160B	0,55	80M	80	360	182	160	50	800	130	540	360	320	60	18	820	342			62,2
40-160A	0,75	80M	80	360	182	160	50	800	130	540	360	320	60	18	820	342	65	40	74,2
40-160AP	0,75	80M	80	360	182	160	50	800	130	540	360	320	60	18	820	342			74,2
40-160AP	1,1	90S	80	360	182	160	50	800	130	540	360	320	60	18	855	342	65	40	87,2
40-200B	1,1	90S	100	360	210	180	50	900	150	600	390	350	60	18	940	390			93,8
40-200A	1,1	90S	100	360	210	180	50	900	150	600	390	350	60	18	940	390	65	40	93,8
40-200AP	1,1	90S	100	360	210	180	50	900	150	600	390	350	60	18	940	390			93,8
40-200AP	1,5	90S	100	360	210	180	50	900	150	600	390	350	60	18	940	390	65	40	98,8
40-250C	1,5	90S	100	360	230	225	50	1000	170	660	450	400	75	22	1025	455			108,3
40-250B	2,2	100L	100	360	230	225	50	1000	170	660	450	400	75	22	1025	455	65	40	114,3
40-250A	2,2	100L	100	360	230	225	50	1000	170	660	450	400	75	22	1025	455			114,3
50-125B	0,55	80M	100	360	182	160	50	800	130	540	360	320	60	18	840	342	65	50	62,1
50-125A	0,75	80M	100	360	182	160	50	800	130	540	360	320	60	18	840	342			74,1
50-160B	0,75	80M	100	360	210	180	50	800	130	540	360	320	60	18	840	390	65	50	78,6
50-160A	1,1	90S	100	360	210	180	50	800	130	540	360	320	60	18	875	390			91,6
50-200C	1,1	90S	100	360	210	200	50	900	150	600	390	350	60	18	940	410	65	50	97,2
50-200B	1,5	90S	100	360	210	200	50	900	150	600	390	350	60	18	940	410			102,2
50-200A	1,5	90S	100	360	210	200	50	900	150	600	390	350	60	18	940	410	65	50	102,2
50-250C	2,2	100L	100	360	230	225	50	1000	170	660	450	400	75	22	1025	455			118,2
50-250B	3	100L	100	360	230	225	50	1000	170	660	450	400	75	22	1025	455	65	50	122,2
50-250A	4	112M	100	360	230	225	50	1000	170	660	450	400	75	22	1025	455			128,2
50-315C	5,5	132S	125	470	275	280	50	1120	190	740	490	440	75	22	1170	555	80	50	200,1
50-315B	7,5	132M	125	470	275	280	50	1120	190	740	490	440	75	22	1200	555			186,6
50-315A	11	160M	125	470	275	280	50	1250	205	840	540	490	75	22	1303	555	80	50	260,1



TYPE	kW	Motor Size	DIMENSIONS (mm)															Kg			
			a	f	h4	h2	h3	L1	L2	L3	B2	B3	A	d	T	H	DNA		DNM		
65-125B	0,75	80M	100	360	210	180	50	800	130	540	360	320	60	18	840	390	80	65	80,4		
65-125A	1,1	90S	100	360	210	180	50	800	130	540	360	320	60	18	875	390			93,4		
65-160C	1,5	90S	100	360	210	200	50	900	150	600	390	350	60	18	940	410			105,5		
65-160B	1,5	90S	100	360	210	200	50	900	150	600	390	350	60	18	940	410			105,5		
65-160A	2,2	100L	100	360	210	200	50	900	150	600	390	350	60	18	940	410			111,5		
65-200C	2,2	100L	100	360	230	225	50	1120	190	740	490	440	75	22	1145	455			124,8		
65-200B	3	100L	100	360	230	225	50	1120	190	740	490	440	75	22	1145	455			128,8		
65-200A	3	100L	100	360	230	225	50	1120	190	740	490	440	75	22	1145	455			128,8		
65-250B	4	112M	100	470	250	250	50	1120	190	740	490	440	90	22	1130	500			159,0		
65-250B	5,5	132S	100	470	250	250	50	1120	190	740	490	440	90	22	1175	500			183,0		
65-250A	5,5	132S	100	470	250	250	50	1120	190	740	490	440	90	22	1175	500			183,0		
65-315CM	7,5	132M	125	470	275	280	50	1250	205	840	540	490	90	22	1285	555			194,0		
65-315BM	11	160M	125	470	275	280	50	1250	205	840	540	490	90	22	1343	555			262,5		
65-315AM	11	160M	125	470	275	280	50	1250	205	840	540	490	90	22	1343	555			262,5		
80-160E	1,1	90S	125	360	230	225	50	1000	170	660	450	400	75	22	1050	455			100	80	115,1
80-160D	1,5	90S	125	360	230	225	50	1000	170	660	450	400	75	22	1050	455					120,1
80-160C	1,5	90S	125	360	230	225	50	1000	170	660	450	400	75	22	1050	455	120,1				
80-160B	2,2	100L	125	360	230	225	50	1000	170	660	450	400	75	22	1050	455	126,1				
80-160A	3	100L	125	360	230	225	50	1000	170	660	450	400	75	22	1050	455	130,1				
80-200B	4	112M	125	470	230	250	50	1120	190	740	490	440	75	22	1170	480	157,8				
80-200A	5,5	132S	125	470	230	250	50	1120	190	740	490	440	75	22	1200	480	181,8				
80-250B	5,5	132S	125	470	250	280	50	1250	205	840	540	490	90	22	1285	530	203,8				
80-250A	7,5	132M	125	470	250	280	50	1250	205	840	540	490	90	22	1285	530	190,3				
80-315B	11	160M	125	470	300	315	50	1250	205	840	540	490	90	22	1343	615	273,8				
80-315A	15	160L	125	470	300	315	50	1400	230	940	610	550	90	26	1435	615	305,8				
100-200D	4	112M	125	470	250	280	50	1120	190	740	490	440	90	22	1130	480	125	100			161,0
100-200C	5,5	132S	125	470	250	280	50	1120	190	740	490	440	90	22	1200	530					185,0
100-200B	5,5	132S	125	470	250	280	50	1120	190	740	490	440	90	22	1200	530					186,0
100-200A	7,5	132M	125	470	250	280	50	1120	190	740	490	440	90	22	1240	530					198,0
100-250E	7,5	132M	140	470	275	280	50	1250	205	840	540	490	90	22	1300	555					205,3
100-250D	7,5	132M	140	470	275	280	50	1250	205	840	540	490	90	22	1300	555			205,3		
100-250B	11	160M	140	470	275	280	50	1250	205	840	540	490	90	22	1358	555			273,8		
100-250A	11	160M	140	470	275	280	50	1250	205	840	540	490	90	22	1358	555			273,8		
100-315B	15	160L	140	470	300	315	50	1400	230	940	610	550	90	26	1450	615			327,7		
100-315A	18,5	180M	140	470	300	315	50	1400	230	940	610	550	90	26	1450	615			348,3		
100-400C	22	180L	140	530	365	355	85	1600	270	1060	660	600	110	26	1630	720			469,5		
100-400B	30	200L	140	530	365	355	85	1600	270	1060	660	600	110	26	1630	720			540,8		
100-400A	37	225S	140	530	365	355	85	1600	270	1060	660	600	110	26	1630	720			554,3		
125-250B	11	160M	140	470	300	355	50	1250	205	840	540	490	90	22	1358	655			150	125	308,1
125-250A	15	160L	140	470	300	355	50	1400	230	940	610	550	90	26	1450	655					340,1
125-315C	22	180L	140	530	365	355	85	1600	270	1060	660	600	110	26	1630	720					464,4
125-315B	30	200L	140	530	365	355	85	1600	270	1060	660	600	110	26	1630	720	535,8				
125-315A	37	225S	140	530	365	355	85	1600	270	1060	660	600	110	26	1630	720	549,3				
125-400C	45	225M	140	530	400	400	85	1600	270	1060	660	600	110	26	1630	800	659,2				
125-400B	55	250M	140	530	400	400	85	1600	270	1060	660	600	110	26	1630	800	756,0				
125-400A	75	280S	140	530	400	400	85	1800	300	1200	730	670	110	26	1830	805	939,4				
150-315D	30	200L	160	530	365	400	85	1800	300	1200	730	670	110	26	1850	765	200	150	570,7		
150-315C	37	225S	160	530	365	400	85	1800	300	1200	730	670	110	26	1850	765			584,2		
150-315B	45	225M	160	530	365	400	85	1800	300	1200	730	670	110	26	1850	765			672,1		
150-315A	55	250M	160	530	365	400	85	1800	300	1200	730	670	110	26	1850	765			768,9		
150-400C	75	280S	160	530	400	450	85	1800	300	1200	730	670	110	26	1850	850			951,4		
150-400B	75	280S	160	530	400	450	85	1800	300	1200	730	670	110	26	1850	850			962,8		
150-400A	90	280M	160	530	400	450	85	1800	300	1200	730	670	110	26	1850	850			1057,8		



CA-4CA Serie-Mechanical seal and bearings

MECHANICAL SEAL	PUMP MODEL	SHAFT Ø		STANDARD MATERIAL	OPTIONAL			
					E	V	2E	2V
	32-160, 40-125	20mm	Rotating face Stationary face Elastomer	Ceramic Graphite NBR	Ceramic Graphite EPDM	- - -	SiC SiC EPDM	SiC SiC FKM
	40-250M	28mm	Rotating face Stationary face Elastomer	Ceramic Graphite EPDM	- - -	- - -	SiC SiC EPDM	SiC SiC FKM
	32-200, 32-250, 40-160, 40-200, 40-250, 50-125, 50-160, 50-200, 50-250, 65-125, 65-160, 65-200, 80-160	28mm	Rotating face Stationary face Elastomer	Ceramic Graphite NBR	Ceramic Graphite EPDM	Ceramic Graphite FKM	SiC SiC EPDM	SiC SiC FKM
	50-315, 65-250, 65-315M, 80-200, 80-315, 100-315	40mm	Rotating face Stationary face Elastomer	CrNi-steel Graphite NBR	CrNi-steel Graphite EPDM	CrNi-steel Graphite FKM	SiC SiC EPDM	SiC SiC FKM
	50-315N, 65-315N, 80-315N	40mm	Rotating face Stationary face Elastomer	Graphite SiC FKM	Graphite SiC EPDM	- - -	- - -	- - -
	80-250, 100-200, 100-250, 125-250	45mm	Rotating face Stationary face Elastomer	CrNi-steel Graphite NBR	CrNi-steel Graphite EPDM	CrNi-steel Graphite FKM	SiC SiC EPDM	SiC SiC FKM
	100-400, 125-315, 125-400, 150-315, 150-400	55mm	Rotating face Stationary face Elastomer	Graphite SiC FKM	- - -	- - -	SiC SiC EPDM	SiC SiC FKM
	200-315, 200-400, 250-315, 250-400	70mm	Rotating face Stationary face Elastomer	Graphite SiC FKM	- - -	- - -	SiC SiC EPDM	SiC SiC FKM

PUMP BEARINGS	PUMP MODEL	TYPE	
	32-160, 32-200, 32-250, 40-125, 40-160, 40-200, 40-250, 40-250M, 50-125, 50-160, 50-200, 50-250, 65-125, 65-160, 65-200, 80-160	6306-ZZ C3	6306-ZZ C3
	50-315, 65-250, 65-315, 80-200, 80-315, 100-315	3208-ZZ C3	3208-ZZ C3
	50-315N, 65-315N, 80-250, 80-315N, 100-200, 100-250, 125-250	6209-ZZ C3	6309-ZZ C3
	100-400, 125-315, 125-400, 150-315, 150-400	6211-ZZ C3	6311-ZZ C3
	200-315, 200-400, 250-315, 250-400, 250-400	6313-ZZ C3	6313-ZZ C3

